



Spec. No.	PS-DT-S56320/S56321T9
Rev.	A

PRODUCT SPECIFICATION

Model No:CST-S56320T9/S56321T9

Descriptions:

- 0.56 Inch Triad Digit SMD Display
- Emitting Color : Super Bright Yellow



CUSTOMER APPROVED SIGNATURES	APPROVED BY	CHECKED BY	PREPARED BY

CHINA SEMICONDUCTOR CORPORATION
Address:2FL. NO.909,Chung-Cheng Road,
Chung-Ho City Taipei Hsien,Taiwan.

Tel:886-2-2223-9696
Fax:886-2-2223-9377

OPTO PLUS TECHNOLOGIES CO.,LTD
Address:696 Shun jiang Rd.,Ji Shan St.Shaoxing,
ZheJiang,China

Tel:86-0575-88623888
Fax:86-0575-88623112



Model No : CST-S56320/S56321T9

Features -

1. 0.56 inch (14.20mm) digit height.
2. Qualified according to JEDEC moisture sensitivity Level 2a.
3. RoHS compliant.
4. Low power consumption.
5. Easy mounting on P.C. board.

Device Selection Guide -

Model No.	Chip		Description
	Material	Emitting Color	
CST-S56320T9	AlGaInP	Super Bright Yellow	Common Anode
CST-S56321T9	AlGaInP	Super Bright Yellow	Common Cathode

Mechanical Dimensions -

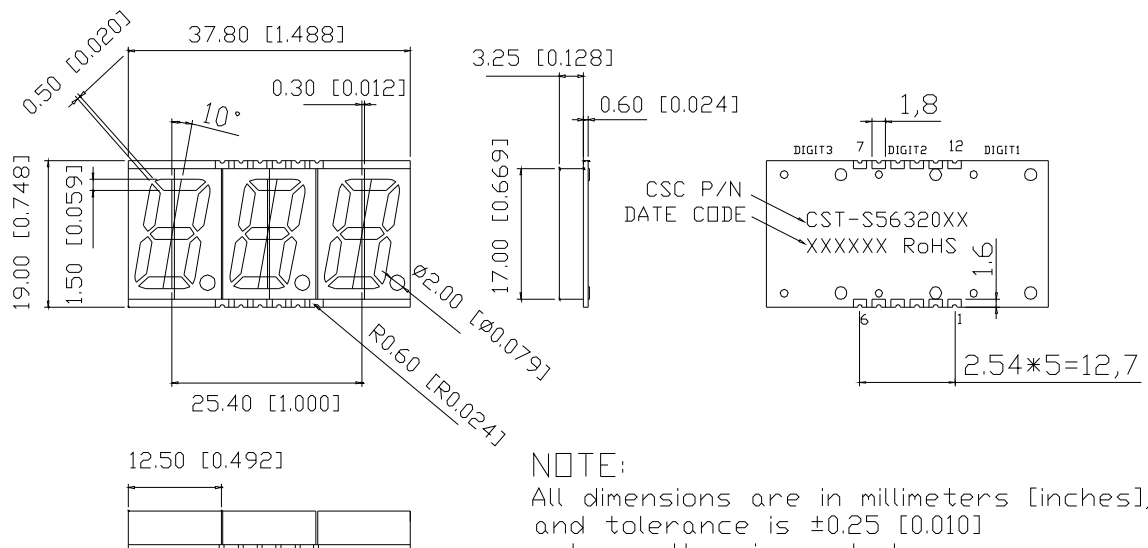



Model No : CST-S56320/S56321T9

Internal Circuit Diagrams -

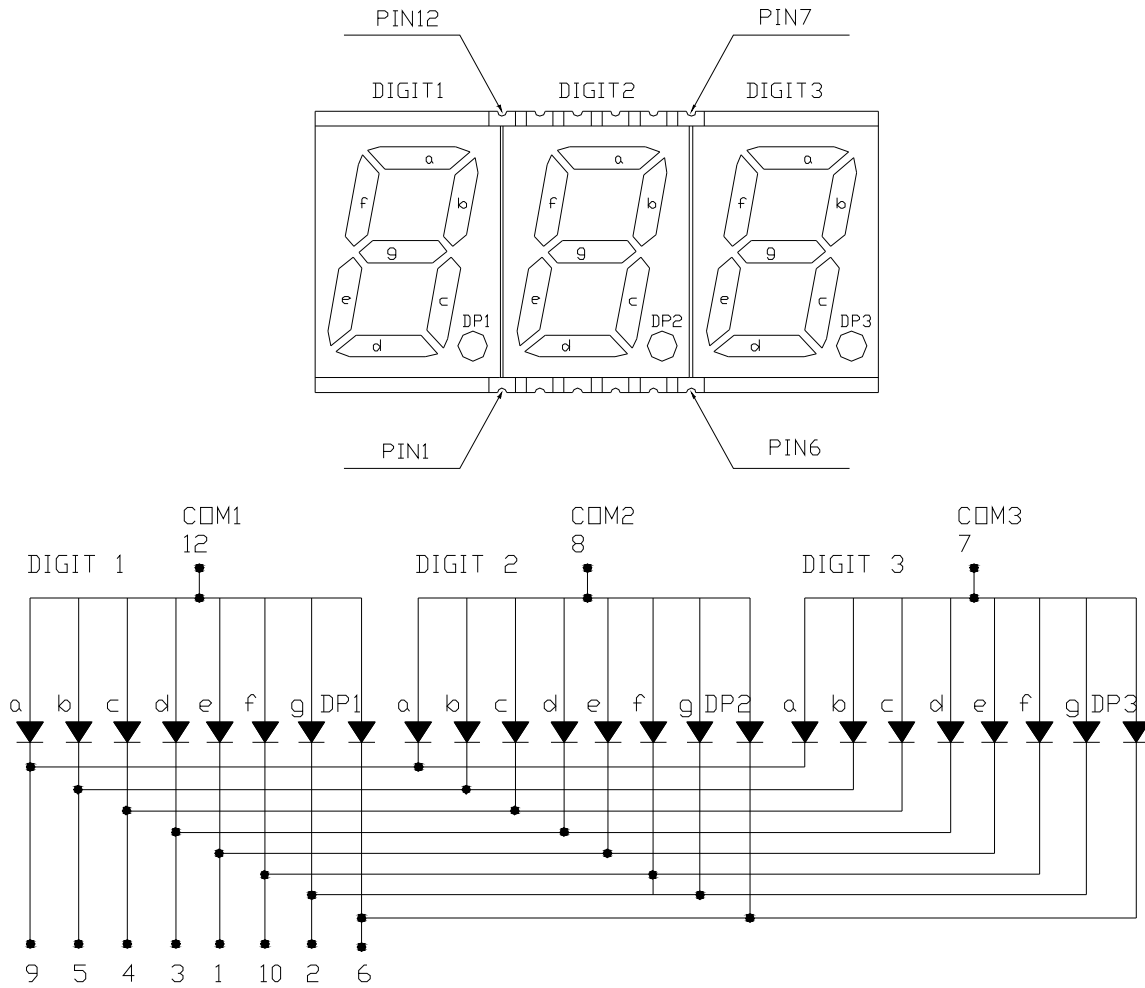

PIN 11 NC.

CST-S56320 Common Anode.
(CST-S56321 Common Cathode.)



Model No : CST-S56320/S56321T9

■ Absolute Maximum Rating -

(Ta=25°C)

Parameter	Symbol	Rating	Unit
Power Dissipation Per Dice	P _{AD}	70	mW
Continuous Forward Current Per Dice	I _{AF}	25	mA
Peak Current Per Dice(duty cycle 1/10,1KHz)	I _{PF}	90	mA
Derating Linear From 25°C Per Dice	-	0.33	mA/°C
Reverse Voltage Per Dice	V _R	5	V
Operating Temp.	T _{opr}	-40 ~ +105	°C
Storage Temp.	T _{stg}	-40 ~ +105	°C

Note:Solder temperature 1/16 inch below seating plane for 3 seconds at 260°C

■ Electro-optical Characteristics -

(Ta=25°C)

Parameter	Symbol	Min.	Typ.	Max.	Unit	Condition
Forward Voltage Per Segment	V _F	-	2.1	2.8	V	I _F =20mA
Luminous Intensity Per Segment	I _v	7	18	-	mcd	I _F =10mA
Peak Emission Wavelength	λ _P	-	592	-	nm	I _F =20mA
Spectrum Radiation Bandwidth	Δλ	-	20	-	nm	I _F =20mA
Reverse Current	I _R	-	-	100	μA	V _R =5V
Luminous Intensity Matching Ratio	I _{V-m}	-	-	2:1	-	I _F =10mA



Model No : CST-S56320/S56321T9

Typical Electrical / Optical Characteristics Curves -

(Ta = 25°C Unless Otherwise Noted)

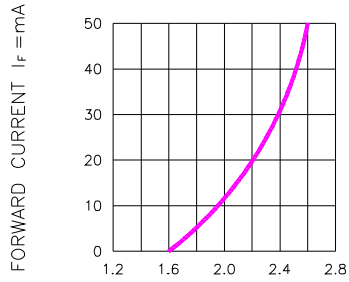

Fig.1 FORWARD CURRENT VS. FORWARD VOLTAGE

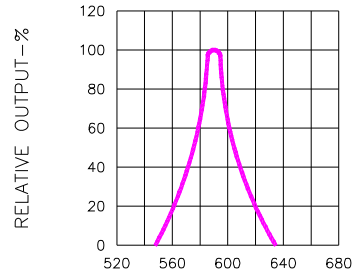

Fig.2 SPECTRAL RESPONSE

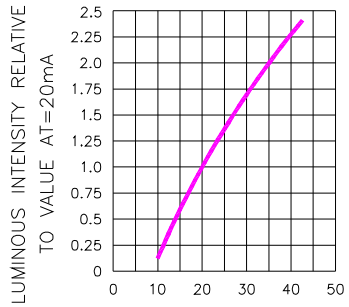

Fig.3 RELATIVE LUMINOUS INTENSITY VS. FORWARD CURRENT

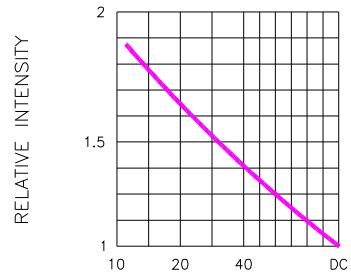

Fig.5 LUMINOUS INTENSITY VS. DUTY CYCLE (AVERAGE I_f = 10mA)

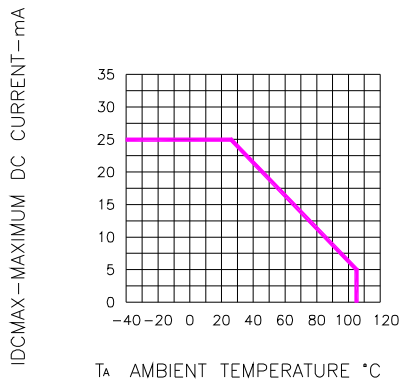

Fig.4 MAXIMUM ALLOWABLE DC CURRENT PER SEGMENT VS. A FUNCTION OF AMBIENT TEMPERATURE

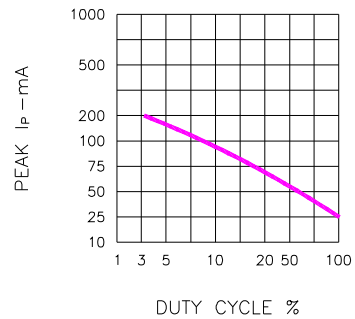

Fig.6 MAX PEAK CURRENT VS. DUTY CYCLE % (REFRESH RATE f = 1 KHz)



Model No : CST-S56320/S56321T9

SMT REFLOW SOLDERING INSTRUCTIONS

IR Reflow Temperature / Time :

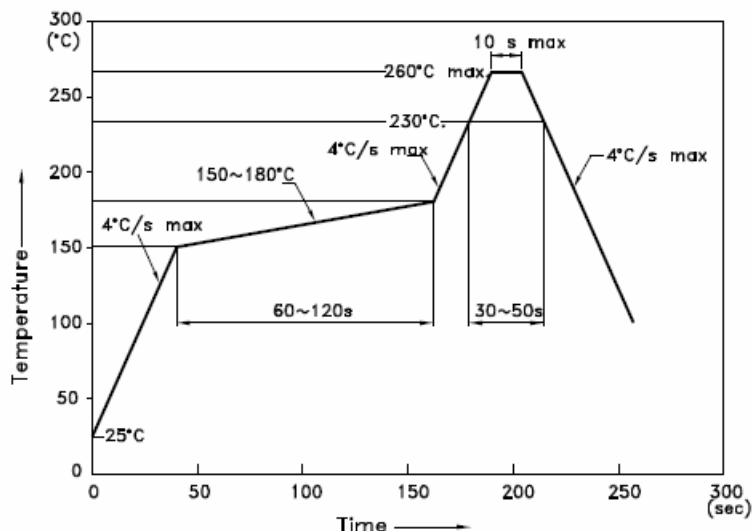

NOTES:

1. We recommend the reflow temperature 245°C(+/-5°C). The maximum soldering temperature should be limited to 260°C.
2. Don't cause stress to the epoxy resin while it is exposed to high temperature.
3. Number of reflow process shall be 2 times or less.

Soldering Pad Size

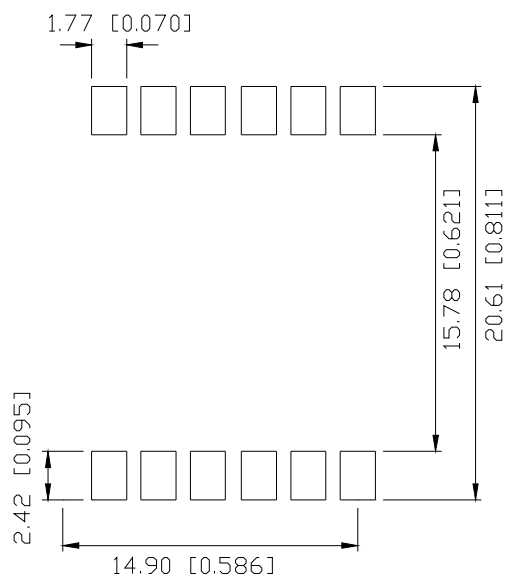



Spec. No.	PS-DT-S56320/S56321T9
Rev.	A

Model No : CST-S56320/S56321T9

REEL DIMENSIONS

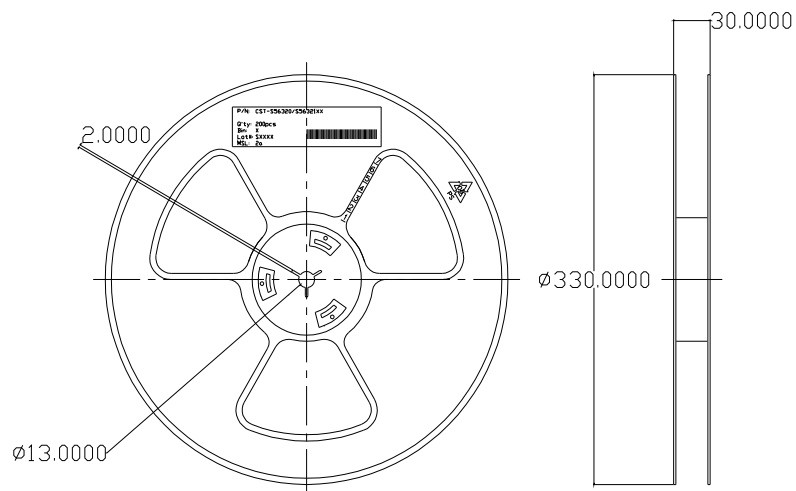

PACKING & LABEL SPECIFICATIONS

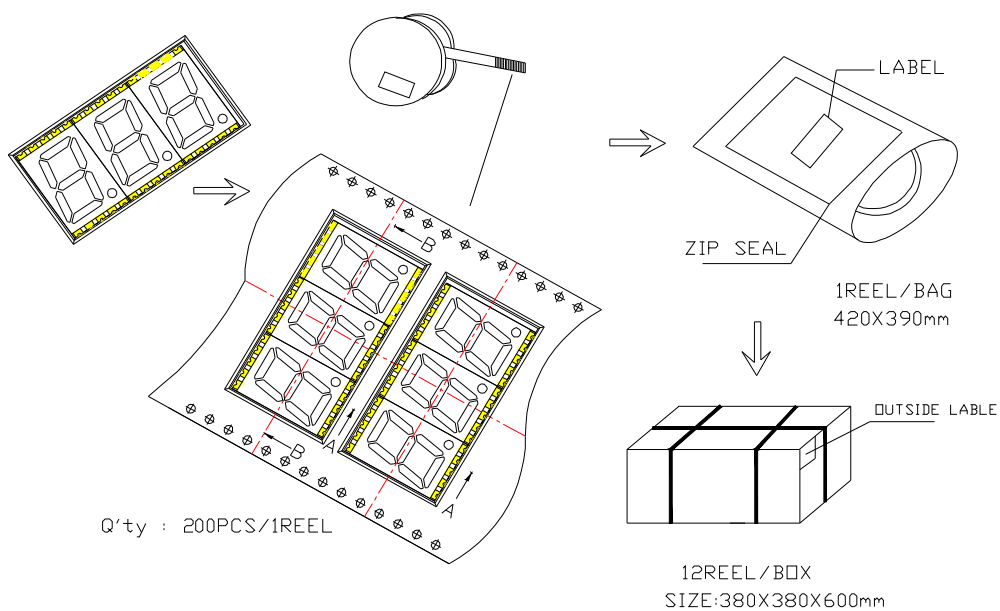

Note: The specifications are subject to change without notice. Please contact us for updated information.