



# MIC3223

## High Power Boost LED Driver with Integrated FET

### General Description

The MIC3223 is a constant current boost LED driver capable of driving a series string of high power LEDs. The MIC3223 can be used in general lighting, bulb replacement, garden pathway lighting and other solid state illumination applications.

The MIC3223 is a peak current mode control PWM boost regulator and the 4.5V and 20V operating input voltage range allows multiple applications from a 5V or a 12V bus.

The MIC3223 implements a fixed internal 1MHz switching frequency to allow for a reduction in the design footprint size. Power consumption has been minimized through the implementation of a 200mV feedback voltage that provides an accuracy of  $\pm 5\%$ . The MIC3223 can be dimmed through the use of a PWM signal and features an enable pin for a low power shutdown state.

The MIC3223 is a very robust LED driver and offers the following protection features: over voltage protection (OVP), thermal shutdown, switch current limiting and under voltage lockout (UVLO).

The MIC3223 is offered in a low profile exposed pad 16-pin TSSOP package.

Data sheets and support documentation can be found on Micrel's web site at: [www.micrel.com](http://www.micrel.com).

### Features

- 4.5V to 20V supply voltage
- 200mV feedback voltage with an accuracy of  $\pm 5\%$
- Step-up output voltage (boost) conversion up to 37V
- 1MHz switching frequency
- 100m $\Omega$ /3.5A internal power FET switch
- LEDs can be dimmed using a PWM signal
- User settable LED current (through external resistor)
- Externally programmable soft-start
- Protection features that include:
  - Output over-voltage protection (OVP)
  - Under-voltage lockout (UVLO)
  - Over temperature protection
- Junction temperature range:  $-40^{\circ}\text{C}$  to  $+125^{\circ}\text{C}$
- Available in a exposed pad 16-pin TSSOP package

### Applications

- Architectural lighting
- Industrial lighting
- Signage
- Landscape lighting (garden/pathway)
- Under cabinet lighting
- MR-16 bulbs

### Typical Application

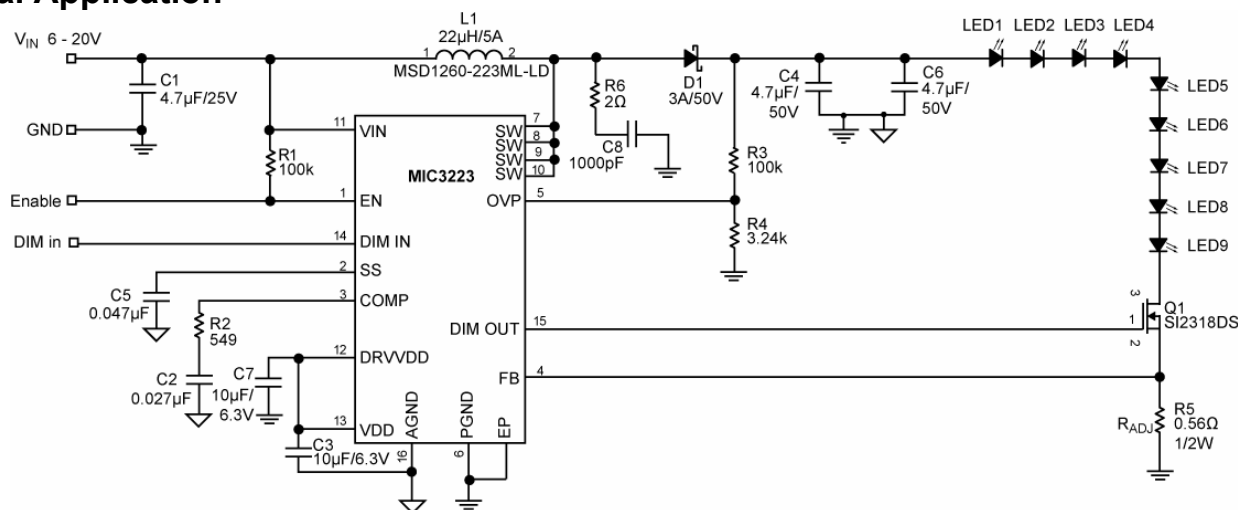

## Ordering Information

| Part Number | Junction Temp. Range | Package           | Lead Finish |
|-------------|----------------------|-------------------|-------------|
| MIC3223YTSE | -40° to +125°C       | 16-pin ePad TSSOP | PB- free    |

## Pin Configuration

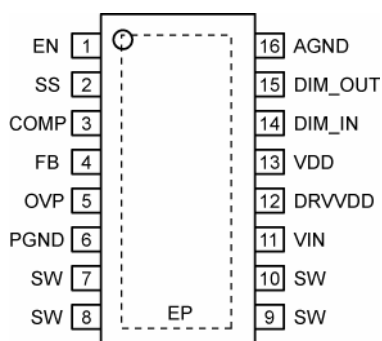

16-Pin ePad TSSOP (TSE)

## Pin Description

| Pin Number | Pin Name | Pin Function   |
|------------|----------|--|
| 1          | EN       | Enable (Input): Logic high enables and logic low disables operation.   |
| 2          | SS       | Soft Start (Input resistance of 30k). Connect a capacitor to GND for soft-start. Clamp the pin to a known voltage to control the internal reference voltage and hence the output current.  |
| 3          | COMP     | Compensation Pin (Input): Add external R and C-to-GND to stabilize the converter.  |
| 4          | FB       | Negative Input to Error Amp  |
| 5          | OVP      | Connect to the centre tap of an external resistor divider, the top of which is tied to Vout and bottom-to-ground.  |
| 6          | PGND     | Power Ground   |
| 7,8,9,10   | SW       | Switch Node (Input): Internal NMOS switch Drain Pin  |
| 11         | VIN      | Input Supply   |
| 12         | DRVVDD   | For 4.5V < VIN < 6V, connect DRVVDD to VIN. DRVVDD is the input voltage supply for the converter's internal power FET gate driver. For VIN > 6V, connect this pin to VDD.  |
| 13         | VDD      | For 4.5V < VIN < 6V, this pin becomes the input voltage supply for the converter's internal circuit. For VIN > 6V, this pin is an output of the internal 5.5V regulator that supplies internal circuits. User must add 10µF decoupling capacitor from VDD-to-AGND. |
| 14         | DIM_IN   | PWM input to control LED dimming.  |
| 15         | DIM_OUT  | Output driver to drive external FET for LED dimming.   |
| 16         | AGND     | Analog Ground  |
| 17         | EP       | Connect to Power Ground  |

**Absolute Maximum Ratings<sup>(1)</sup>**

|  |                               |
|--|-------------------------------|
| Supply Voltage ( $V_{IN}$ )                    | +22V                          |
| Switch Voltage ( $V_{SW}$ )                    | -0.3V to +42V                 |
| Regulated Voltage ( $V_{DD}$ )                 | -0.3V to +6.5V                |
| Dimming In Voltage ( $V_{DIM\_IN}$ )           | -0.3V to ( $V_{DD} + 0.3V$ )  |
| Dimming Out Voltage ( $V_{DIM\_OUT}$ )         | -0.3V to ( $V_{DD} + 0.3V$ )  |
| Soft-Start Voltage ( $V_{SS}$ )                | -0.3V to ( $V_{DD} + 0.3V$ )  |
| Enable Voltage ( $V_{EN}$ )                    | -0.3V to ( $V_{IN} + 0.3V$ )  |
| Feedback Voltage ( $V_{FB}$ )                  | -0.3V to ( $V_{DD} + 0.3V$ )  |
| Switch Current ( $I_{SW}$ )                    | Internally Limited            |
| Comp Voltage ( $V_{COMP}$ )                    | -0.3V to ( $+V_{DD} + 0.3V$ ) |
| FET Driver Supply ( $V_{DRVDD}$ )              | -0.3V to +6.5V                |
| PGND to AGND                                   | -0.3V to +0.3V                |
| Over Voltage Protection ( $V_{OVP}$ )          | -0.3V to ( $V_{DD} + 0.3V$ )  |
| Peak Reflow Temperature (soldering, 10-20sec.) | 260°C                         |
| Storage Temperature ( $T_S$ )                  | -65°C to +150°C               |
| ESD Rating <sup>(3)</sup>                      | +2kV                          |

**Operating Ratings<sup>(2)</sup>**

|                                  |                 |
|----------------------------------|-----------------|
| Supply Voltage ( $V_{IN}$ )      | +4.5V to +20V   |
| Switch Voltage ( $V_{SW}$ )      | +37V            |
| Junction Temperature ( $T_J$ )   | -40°C to +125°C |
| Junction Thermal Resistance      |                 |
| ePad TSSOP-16L ( $\theta_{JA}$ ) | 36.5°C/W        |

**Electrical Characteristics<sup>(4)</sup>**

$V_{IN} = V_{EN} = 12V$ ;  $L = 22\mu H$ ,  $C_{IN} = 4.7\mu F$ ,  $C_{OUT} = 2 \times 4.7\mu F$ ;  $T_A = 25^\circ C$ , **BOLD** values indicate  $-40^\circ C \leq T_J \leq +125^\circ C$ , unless otherwise noted.

| Symbol           | Parameter                         | Condition  | Min        | Typ  | Max        | Units      |
|------------------|-----------------------------------|--|------------|------|------------|------------|
| $V_{IN}$         | Voltage Supply Range              |  | <b>4.5</b> |      | <b>20</b>  | V          |
| $V_{UVLO}$       | Under Voltage Lockout             | Monitoring for $V_{DD}$                                      | 3          | 3.7  | 4.4        | V          |
| $V_{OVP}$        | Over Voltage Protection           |  | 1.216      | 1.28 | 1.344      | V          |
| $I_{VIN}$        | Quiescent Current                 | $V_{FB} = 250mV$   |            | 2.1  | 5          | mA         |
| $I_{SD}$         | Shutdown Current                  | $V_{EN} = 0V$  |            |      | 10         | $\mu A$    |
| $V_{FB}$         | Feedback Voltage                  | Room Temperature   | 190        | 200  | 210        | mV         |
|                  |                                   | Over Temperature   | <b>184</b> |      | <b>216</b> | mV         |
| $I_{FB}$         | Feedback Input Current            | $V_{FB} = 200mV$   |            | -450 |            | nA         |
| $V_{DD}$         | Internal Voltage Regulator        |  |            | 5.3  |            | V          |
| $D_{MAX}$        | Maximum Duty Cycle                |  | 85         | 90   | 95         | %          |
|                  | $V_{DD}$ Line Regulation          | $V_{LED} = 18V$ , $V_{IN} = 8V$ to $16V$ , $I_{LED} = 350mA$ |            | 0.5  |            | %          |
| $I_{SW}$         | Switch Current Limit              |  | 3.5        | 9    | 10.5       | A          |
| $R_{SW}$         | Switch $R_{DS(on)}$ plus $R_{CS}$ |  |            | 100  |            | m $\Omega$ |
| $I_{SW}$         | Switch Leakage Current            | $V_{EN} = 0$ , $V_{SW} = 37V$                                |            | 0.01 | 10         | $\mu A$    |
| $V_{EN}$         | Enable Threshold                  | Turn On  | 1.5        |      |            | V          |
|                  |                                   | Turn Off   |            |      | 0.4        | V          |
| $I_{EN}$         | Enable Pin Current                |  |            | 20   | 40         | $\mu A$    |
| $V_{DIM\_TH\_H}$ | DIM_IN Threshold High             | Logic High   | 1.5        |      |            | V          |
| $V_{DIM\_TH\_L}$ | DIM_IN Threshold Low              | Logic Low  |            |      | 0.4        | V          |
| Hys              | DIM_IN Hysteresis                 |  |            | 500  |            | mV         |
| $I_{DIM\_IN}$    | DIM_IN Pin Current                | $V_{DIM\_IN} = 5V$   |            |      | 1          | $\mu A$    |
| $T_{DR}$         | Dim Delay (Rising)                | DIM_IN Rising  |            | 40   |            | ns         |
| $T_{DF}$         | Dim Delay (Falling)               | DIM_IN Falling   |            | 30   |            | ns         |

| Symbol          | Parameter                           | Condition  | Min | Typ | Max | Units |
|-----------------|-------------------------------------|--|-----|-----|-----|-------|
| DIM MIN         | Minimum Dimming Pulse               | DIM_IN = 1μs C <sub>DIM_OUT</sub> = 1.25nF<br>DIM_OUT measured from 4V rising to 2.5 falling | 0.7 |     | 1.3 | μs    |
|                 |                                     |  | 0.5 |     | 1.5 | μs    |
| R <sub>DO</sub> | DIM_OUT Resistance High             | DIM_OUT pull up resistance<br>I <sub>DIM_OUT</sub> = +2mA                                    |     | 70  |     | Ω     |
| R <sub>DO</sub> | DIM_OUT Resistance Low              | Dim Out pull down resistance<br>I <sub>DIM_OUT</sub> = -2mA                                  |     | 40  |     | Ω     |
| F <sub>SW</sub> | Oscillator Frequency                |  | 0.7 | 1   | 1.3 | MHz   |
| R <sub>SS</sub> | Soft Start Resistance               |  | 30  | 46  | 62  | kΩ    |
| T <sub>SD</sub> | Over Temperature Threshold Shutdown | Temperature rising   |     | 165 |     | °C    |
|                 |                                     | Hysteresis   |     | 10  |     | °C    |

**Notes**

1. Exceeding the absolute maximum rating may damage the device.
2. The device is not guaranteed to function outside its operating rating.
3. Devices are ESD sensitive. Handling precautions recommended. Human body model, 1.5kΩ in series with 100pF.
4. Specification for packaged product only.

**Test Circuit**

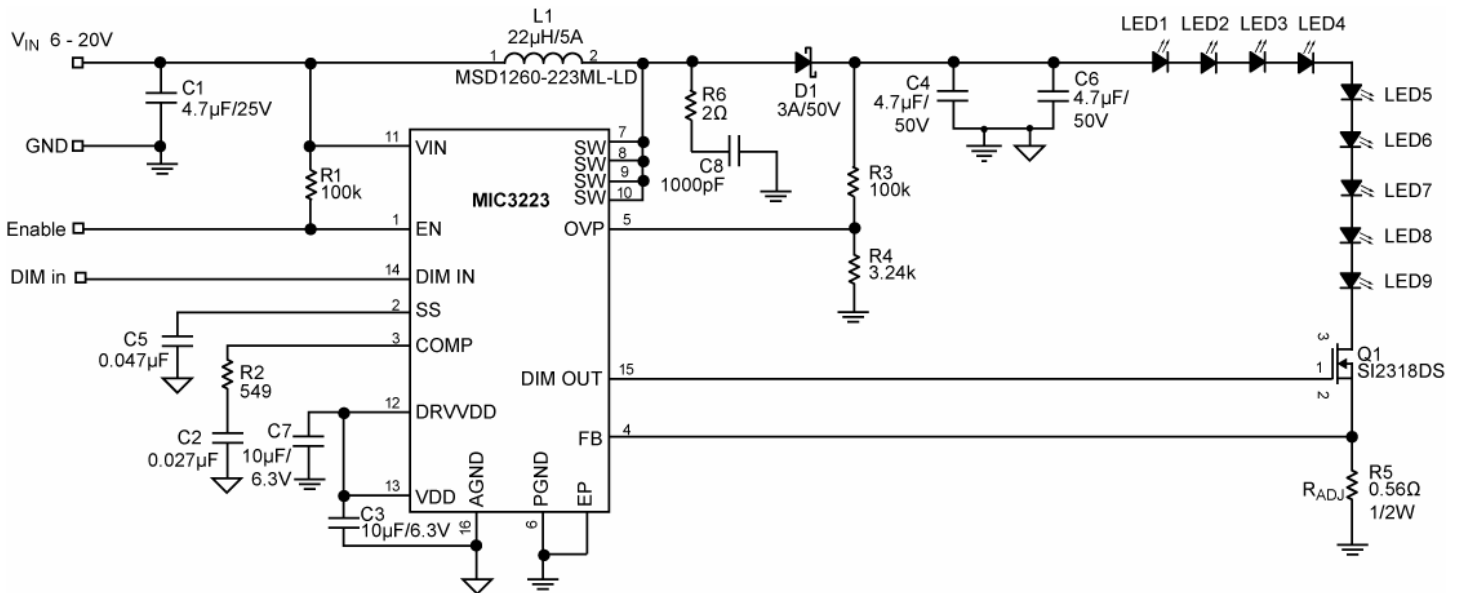

# Typical Characteristics

**Efficiency vs. Input Voltage**

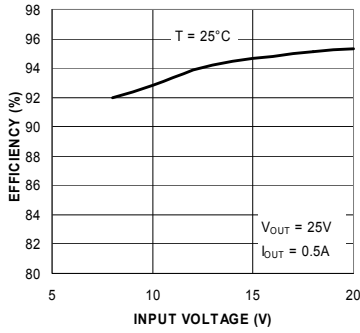

**VDD Voltage vs. Input Voltage**

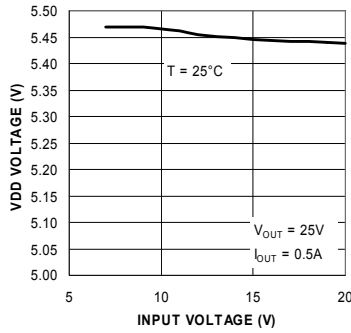

**Current Limit vs. Input Voltage**

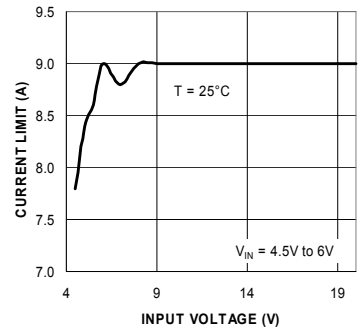

**Feedback Voltage vs. Input Voltage**

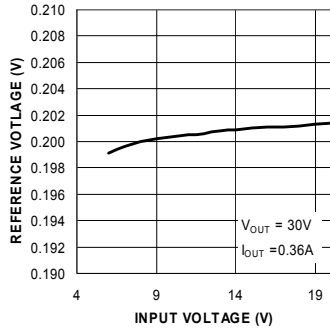

**Switching Frequency vs. Input Voltage**

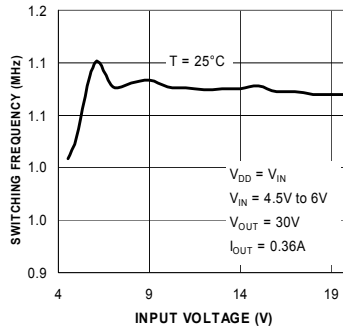

**Feedback Voltage vs. Temperature**

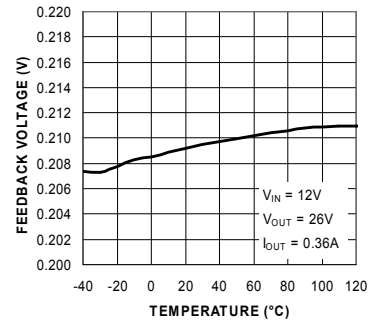

**Current Limit vs. Temperature**

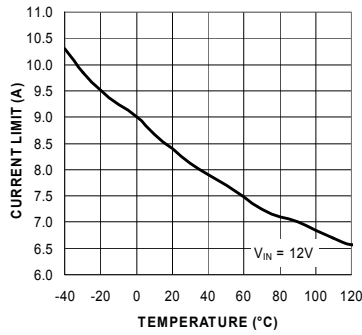

**R<sub>SW\_NODE</sub> vs. Temperature**

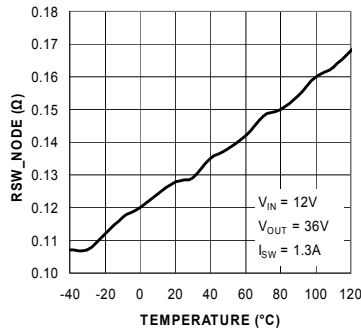

**Switching Frequency vs. Temperature**

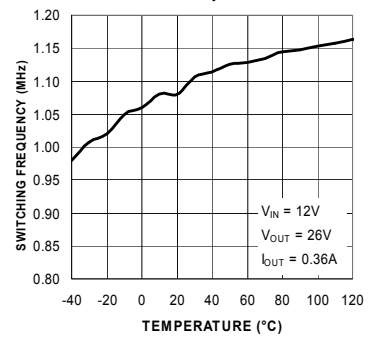

**Efficiency vs. Output Current**

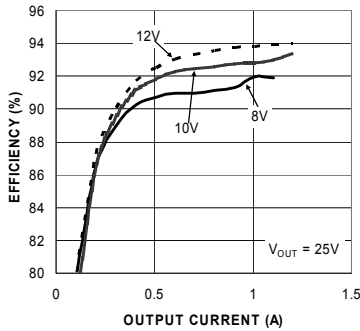

**Efficiency vs. Output Current**

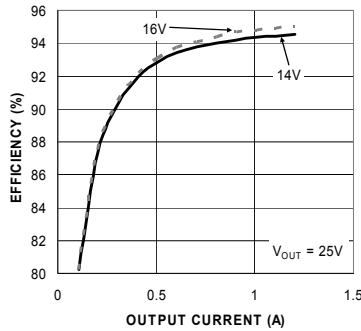

**Efficiency vs. Output Current**

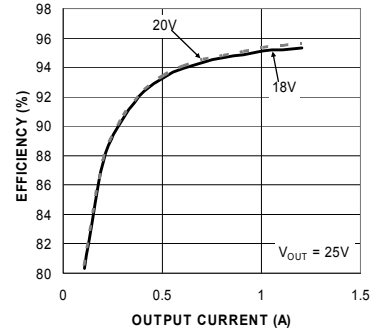

Typical Characteristics (continued)

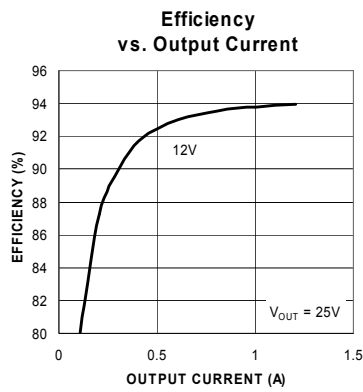
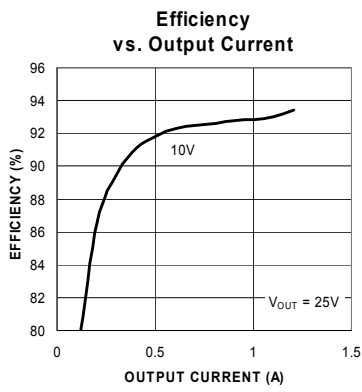

# Functional Characteristics

**500Hz 20% DIM IN**

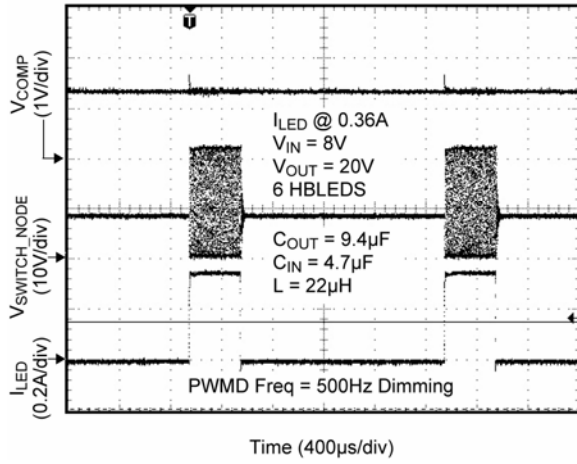

**Switching Waveform**

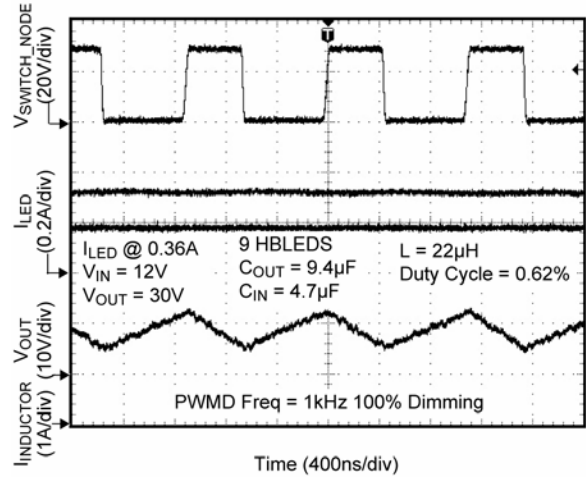

**1kHz DIM IN**

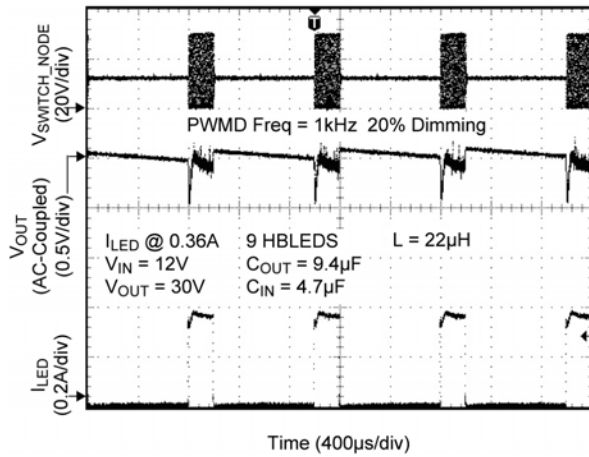

**Zoom In of VOUT Droop @ 1kHz DIM IN**

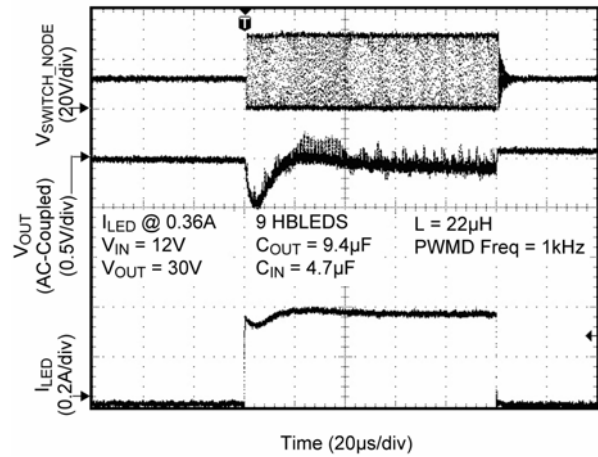

**VOUT Droop @ 100Hz DIM IN**

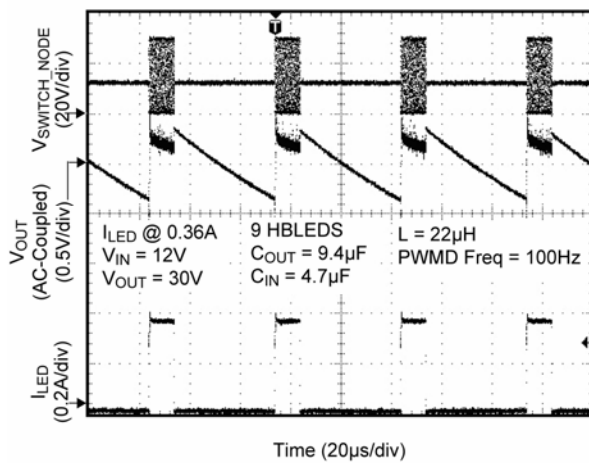

**Zoom In VOUT Droop @ 100Hz DIM IN**

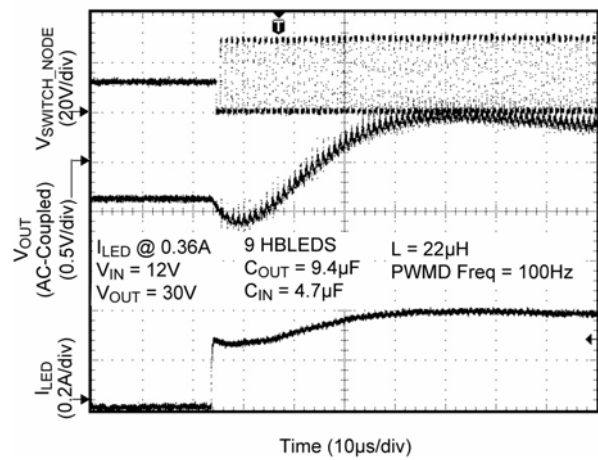

Functional Characteristics (continued)

Enable Turn-On

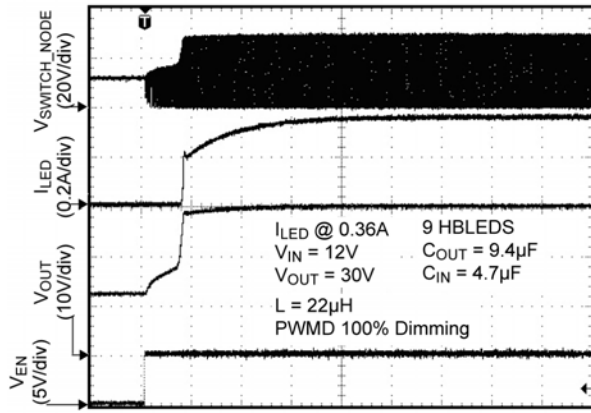

Time (2ms/div)

Enable Turn-Off

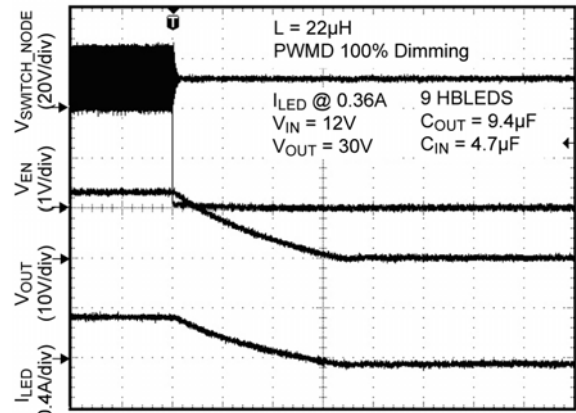

Time (1s/div)

Turn-On

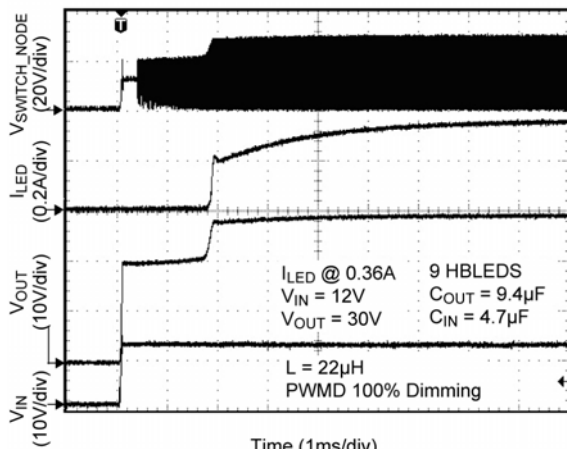

Time (1ms/div)

VIN Turn-On with  $C_{IN} = 1000\mu F$

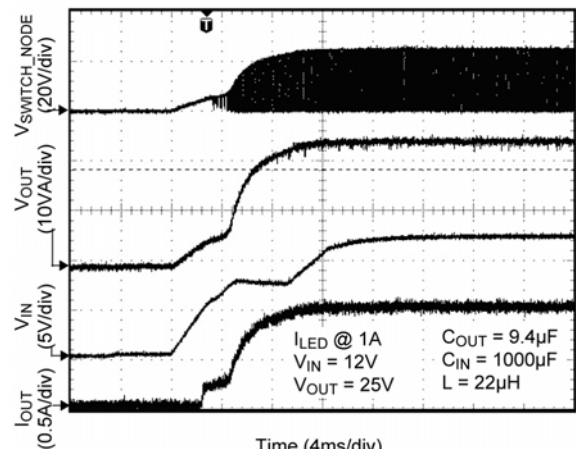

Time (4ms/div)

Current Limit

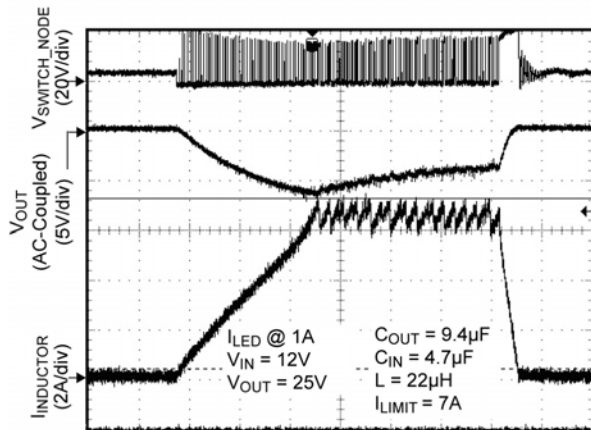

Time (20µs/div)



### Functional Diagram

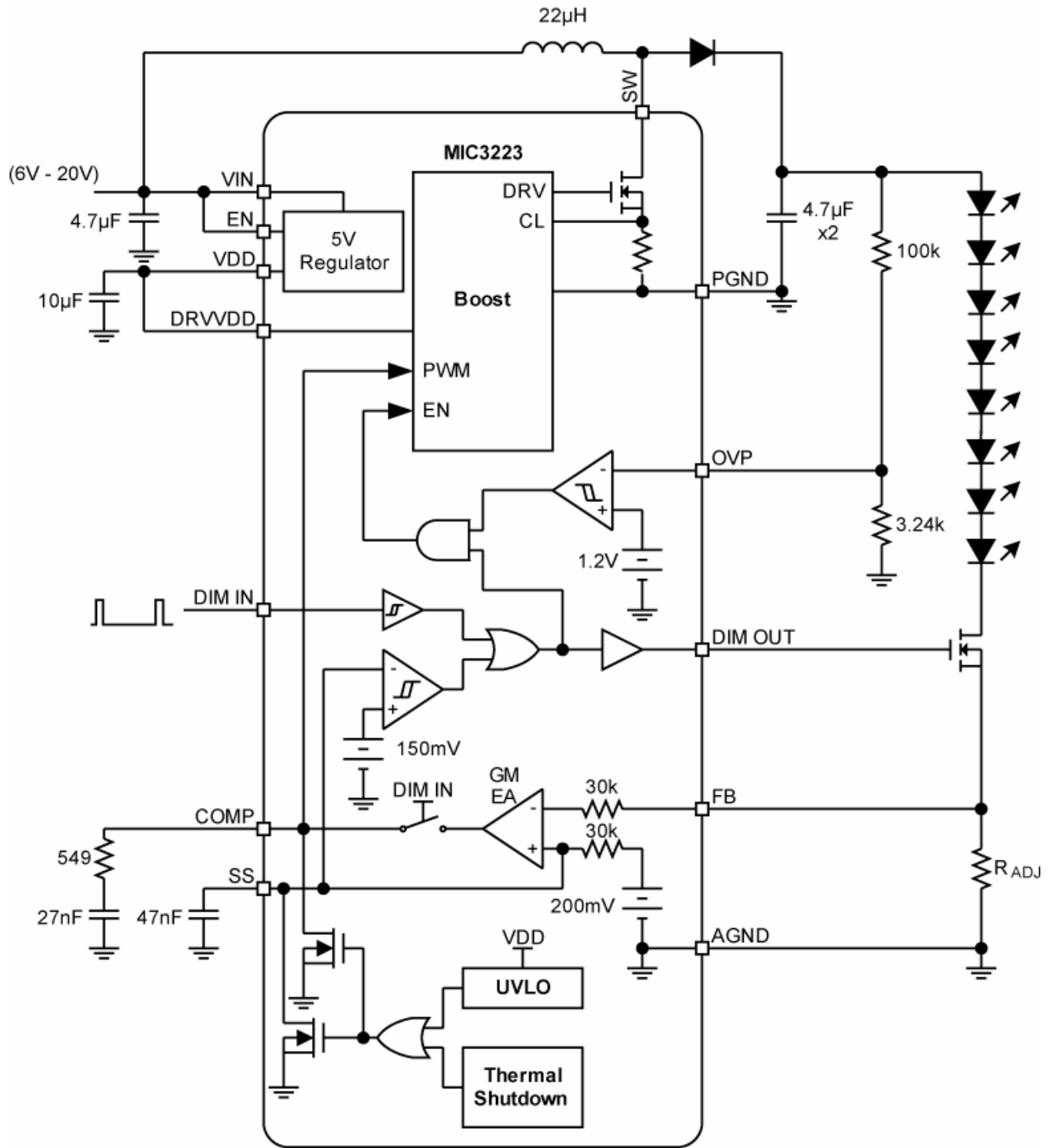

## Functional Description

A constant current output converter is the preferred method for driving LEDs. Small variations in current have a minimal effect on the light output, whereas small variations in voltage have a significant impact on light output. The MIC3223 LED driver is specifically designed to operate as a constant current LED Driver.

The MIC3223 is designed to operate as a boost converter, where the output voltage is greater than the input voltage. This configuration allows for the design of driving multiple LEDs in series to help maintain color and brightness. The MIC3223 can also be configured as a SEPIC converter, where the output voltage can be either above or below the input voltage.

The MIC3223 has an input voltage range, from 4.5V and 20V, to address a diverse range of applications. In addition, the LED current can be programmed to a wide range of values through the use of an external resistor. This provides design flexibility in adjusting the current for a particular application need.

The MIC3223 features a low impedance gate driver capable of switching large MOSFETs. This low impedance provides higher operating efficiency.

The MIC3223 can control the brightness of the LEDs via its PWM dimming capability. Applying a PWM signal (up to 20kHz) to the DIM\_IN pin allows for control of the brightness of the LEDs.

The MIC3223 boost converter employs peak current mode control. Peak current mode control offers advantages over voltage mode control in the following manner. Current mode control can achieve a superior line transient performance compared to voltage mode control and is easier to compensate than voltage mode control, thus allowing for a less complex control loop stability design. Page 9 of this datasheet shows the functional block diagram.

### Boost Converter operation

The boost converter is a peak current mode pulse width modulation (PWM) converter and operates as follows. A flip-flop (FF) is set on the leading edge of the clock cycle. When the FF is set, a gate driver drives the power FET on. Current flows from  $V_{IN}$  through the inductor (L) and through the power switch and also through the current sense resistor to PGND. The voltage across the current sense resistor is added to a slope compensation ramp (needed for stability). The sum of the current sense voltage and the slope compensation voltages (called  $V_{CS}$ ) is fed into the positive terminal of the PWM comparator. The other input to the PWM comparator is the error amp output (called  $V_{EA}$ ). The error amp's negative input is the feedback voltage ( $V_{FB}$ ).  $V_{FB}$  is the voltage across  $R_{ADJ}$  (R5). In this way the output LED

current is regulated. If  $V_{FB}$  drops,  $V_{EA}$  increases and therefore the power FET remains on longer so that  $V_{CS}$  can increase to the level of  $V_{EA}$ . The reverse occurs when  $V_{FB}$  increases.

### PWM Dimming

This control process just described occurs during each DIM\_IN pulse and when ever DIM\_IN is high. When DIM\_IN is low, the boost converter will no longer switch and the output voltage will drop. For high dimming ratios use an external PWM Dimming switch as shown in the Typical Application. When the dim pulse is on the external switch is on and circuit operates in the closed loop control mode as described. When the DIM\_IN is low the boost converter does not switch and the external switch is open and no LED current can flow and the output voltage does not droop. When DIM\_IN goes high the external switch is driven on and LED current flows. The output voltage remains the same (about the same) during each on and off DIM\_IN pulse.

PWM Dimming can also be used in the Test Circuit in applications that do not require high dimming ratios. In the Test Circuit, the load is not removed from the output voltage between DIM\_IN pulses and will therefore drain the output capacitors. The voltage that the output will discharge to is determined by the sum of the  $V_F$  (forward voltage drops of the LEDs). When  $V_{OUT}$  can no longer forward bias the LEDs, then the LED current will stop and the output capacitors will stop discharging. During the next DIM\_IN pulse  $V_{OUT}$  has to charge back up before the full LED current will flow. For applications that do not require high dimming ratios.

## Application Information

### Constant Output Current Converter

The MIC3223 is a peak current mode boost converter designed to drive high power LEDs with a constant current output. The MIC3223 operates with an input voltage range from 4.5V to 20V. In the boost configuration, the output can be set from  $V_{IN}$  up to 37V.

The peak current mode control architecture of the MIC3223 provides the advantages of superior line transient response as well as an easier to design compensation.

The MIC3223 LED driver features a built-in soft start circuitry in order to prevent start-up surges. Other protection features include:

- Current Limit ( $I_{LIMIT}$ ) – Current sensing for over current and overload protection
- Over Voltage Protection (OVP) – output over voltage protection to prevent operation above a safe upper limit
- Under Voltage Lockout (UVLO) – UVLO designed to prevent operation below a safe lower limit

### Setting the LED Current

The current through the LED string is set via the value chosen for the current sense resistor  $R_{ADJ}$  which is R5 in the schematic of the Typical Application. This value can be calculated using Equation 1:

$$\text{Eq. (1)} \quad I_{LED} = \frac{0.2V}{R_{ADJ}}$$

Another important parameter to be aware of in the boost converter design is the ripple current. The amount of ripple current through the LED string is equal to the output ripple voltage divided by the LED AC resistance ( $R_{LED}$  – provided by the LED manufacturer) plus the current sense resistor  $R_{ADJ}$ . The amount of allowable ripple through the LED string is dependent upon the application and is left to the designer's discretion. The equation is shown in Equation 2.

$$\text{Eq. (2)} \quad \Delta I_{LED} \approx \frac{V_{OUT\_RIPPLE}}{(R_{LED} + R_{ADJ})}$$

$$\text{Where} \quad V_{OUT\_RIPPLE} = \frac{I_{LED} \times D}{C_{OUT} \times F_{SW}}$$

### Reference Voltage

The voltage feedback loop the MIC3223 uses an internal voltage of 200mV with an accuracy of  $\pm 5\%$ . The feedback voltage is the voltage drop across the current sense resistor as shown in the Typical Application. When in regulation the voltage at  $V_{FB}$  will equal 200mV.

### Output Over Voltage Protection (OVP)

The MIC3223 provides an OVP circuitry in order to protect the system from an overvoltage fault condition. This OVP threshold can be programmed through the use of external resistors (R3 and R4 in the Typical Application). A reference value of 1.245V is used for the OVP. Equation 3 can be used to calculate the resistor value for R9 to set the OVP point. Normally use 100k for R3.

$$\text{Eq. (3)} \quad R4 = \frac{R3}{(V_{OVP}/1.245) - 1}$$

### VDD

An internal linear regulator is used to provide the necessary internal bias voltages. When  $V_{IN}$  is 6V or below connect the  $V_{DD}$  pin to  $V_{IN}$ . Use a 10 $\mu$ F ceramic bypass capacitor.

### DRVDD

An internal linear regulator is used to provide the necessary internal bias voltages to the gate driver that drives the external FET. When  $V_{IN}$  is above 6V connect DRVDD to VDD.

When  $V_{IN}$  is 6V or below connect the DRVDD pin to  $V_{IN}$ . Use a bypass capacitor, 10 $\mu$ F ceramic capacitor.

### UVLO

Internal under voltage lock out (UVLO) prevents the part from being used below a safe  $V_{IN}$  voltage. The UVLO is 3.7V. Operation below 4.5V is not recommended.

### Soft Start

Soft start is employed to lessen the inrush currents during turn on. At turn on the following occurs;

1. After about 1.5ms  $C_{SS}$  will start to rise in an exponential manner according to;

$$V_{SS} = 0.2 \left( 1 - e^{\frac{-t}{(37k\Omega \times C_{SS})}} \right)$$

2. According to the block diagram,  $V_{SS}$  is the ref node of the error amp. PWM switching start when  $V_{SS}$  begins to rise.
3. When the  $C_{SS}$  is fully charged, 0.2V will be at the error amp reference and steady state operation begins.
4. Design for soft-start time using the above equation.

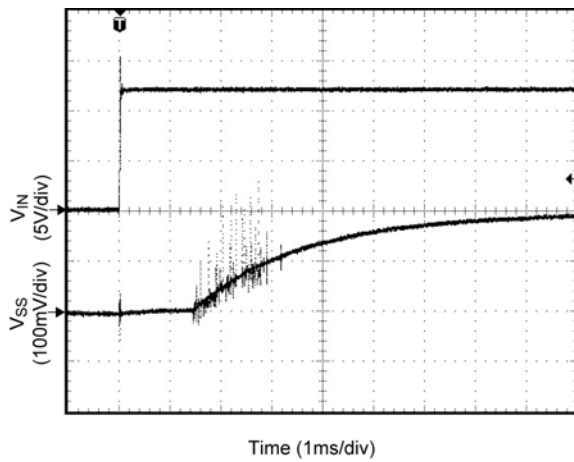

Figure 1. Soft start

**LED Dimming**

The MIC3223 LED driver can control the brightness of the LED string via the use of pulse width modulated (PWM) dimming. An input signal from DC up to 20kHz can be applied to the DIM\_IN pin (see Typical Application) to pulse the LED string ON and OFF. It is recommended to use PWM dimming signals above 120Hz to avoid any recognizable flicker by the human eye. PWM dimming is the preferred way to dim an LED in order to prevent color/wavelength shifting. Color wavelength shifting will occur with analog dimming. By employing PWM Dimming the output current level remains constant during each DIM\_IN pulse. The boost converter switches only when DIM\_IN is high. Between DIM\_IN pulses the output capacitors will slowly discharge. The higher the DIM\_IN frequency the less the output capacitors will discharge.

**PWM Dimming Limits**

The minimum pulse width of the DIM\_IN is determined by the DIM\_IN frequency and the L and C used in the boost stage output filter. At low DIM\_IN frequencies lower dimming ratios can be achieved.

$$\text{Dim\_ratio} = \frac{\text{LED\_ON\_TIME}}{\text{PERIOD}_{\text{PWM}}}$$

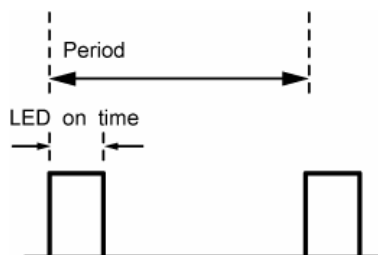

Figure 2. DIM\_IN Dimming Ratio

If high dimming ratios are required, a lower Dimming frequency is required. During each DIM\_IN pulse the inductor current has to ramp up to its steady state value in order for the programmed LED current to flow. The smaller the inductance value the faster this time is and a narrower DIM\_IN pulse can be achieved. But smaller inductance means higher ripple current.

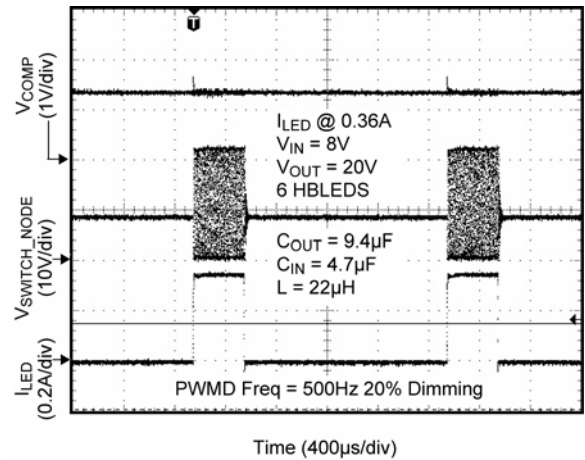

Figure 3. PWM Dimming 20%

Figure 3 shows that switching occurs only during DIM\_IN on pulses. When DIM\_IN is low the boost converter stops switching and the external LED is turned off. The LED current flows only when DIM\_IN is high. Figure 3 shows that the compensation pin (V<sub>COMP</sub>) does not discharge between DIM\_IN pulses. Therefore, when the DIM\_IN pulse starts again the converter resumes operation at the same V<sub>COMP</sub> voltage. This eliminates the need for the comp pin to charge up during each DIM\_IN pulse and allows for high Dimming ratios.

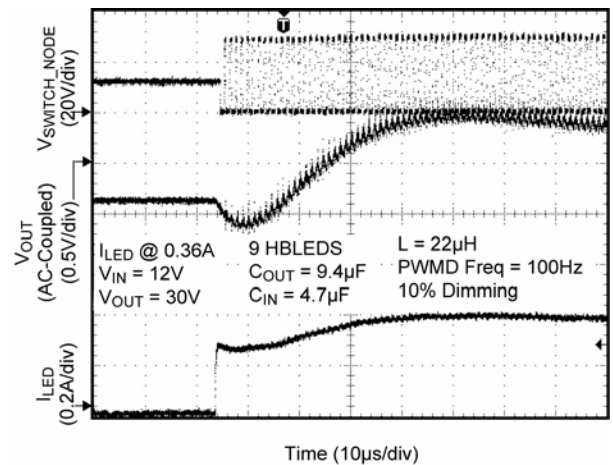

Figure 4. PWM Dimming 10% and I<sub>LED</sub> 100Hz

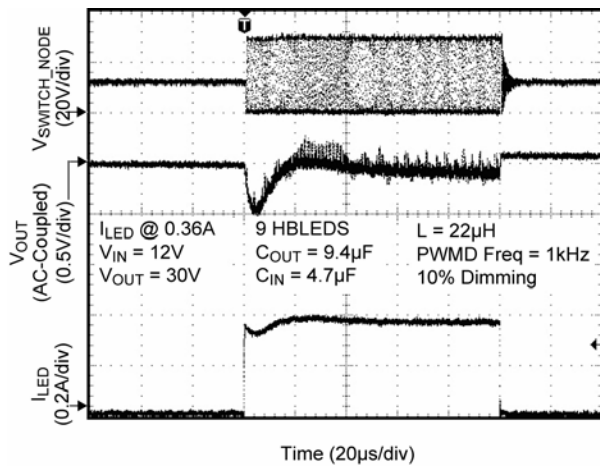

Figure 5. PWM Dimming 20% and I<sub>LED</sub> 1kHz

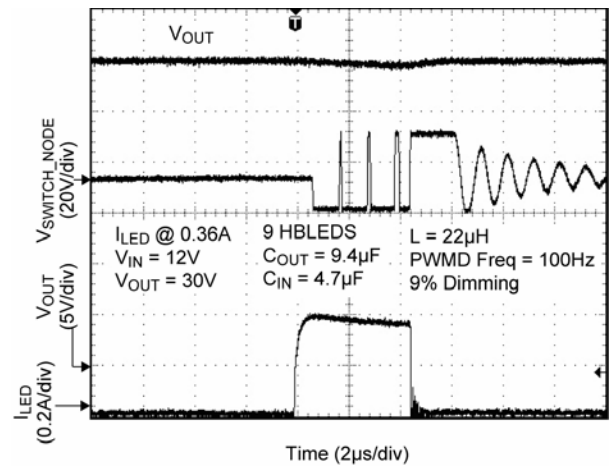

Figure 7. 5µs DIM\_IN Pulse

In Figure 4 is at 100Hz dimming frequency and Figure 5 is 1kHz dimming frequency. The time it takes for the LED current to reach it full value is longer with a lower Dimming frequency. The reason is the output capacitors slowly discharge between dimming pulses.

Figure 7 shows the minimum DIM\_IN pulse at these operating conditions before the I<sub>LED</sub> current starts to drop due to low V<sub>OUT</sub>. The converter is ON (switching) only during a DIM\_IN pulse.

Figure 7 shows that at this DIM\_IN pulse width the converter is ON (switching) long enough to generate the necessary V<sub>OUT</sub> to forward bias the LED string at the programmed current level. Therefore this condition will result in the desired I<sub>LED</sub>.

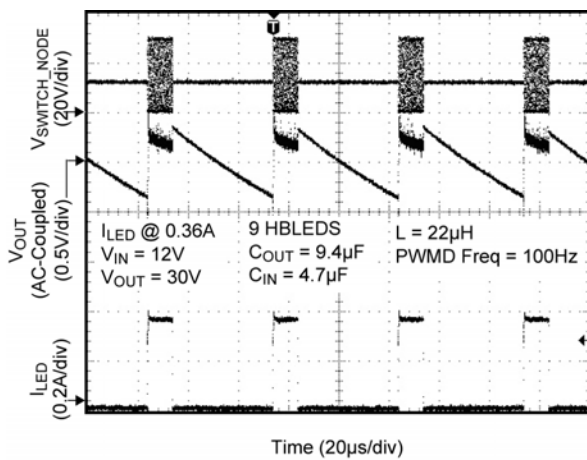

Figure 6. PWM Dimming 20% and I<sub>LED</sub> 1kHz

Figure 6 shows the output voltage V<sub>OUT</sub> discharge between DIM\_IN pulses. The amount of discharge is dependent on the time between DIM\_IN pulses.

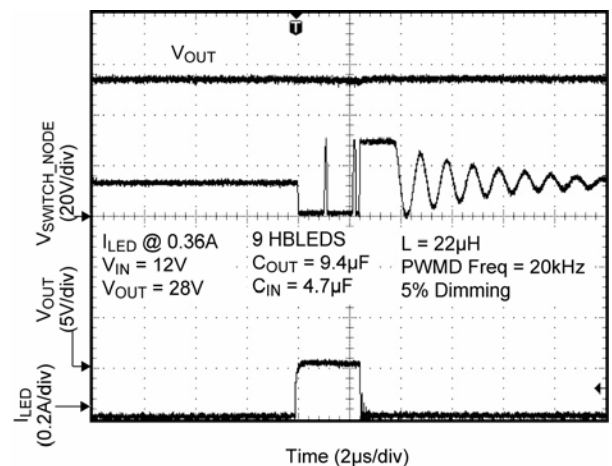

Figure 8. 2.5µs DIM\_IN Pulse

Figure 8 shows that at this DIM\_IN pulse width the converter is not ON (switching) long enough to generate the necessary V<sub>OUT</sub> to forward bias the LED string at the programmed current level. As a result the LED current drops. Therefore, this condition will not result in the desired I<sub>LED</sub>.

## Design Procedure for a LED Driver

| Symbol        | Parameter                      | Min  | Nom  | Max   | Units |
|---------------|--------------------------------|------|------|-------|-------|
| <b>Input</b>  |                                |      |      |       |       |
| $V_{IN}$      | Input Voltage                  | 8    | 12   | 14    | V     |
| $I_{IN}$      | Input Current                  |      |      | 2     | A     |
| <b>Output</b> |                                |      |      |       |       |
| LEDs          | Number of LEDs                 | 5    | 6    | 7     |       |
| $V_F$         | Forward Voltage of LED         | 3.2  | 3.5  | 4.0   | V     |
| $V_{OUT}$     | Output Voltage                 | 16   | 21   | 28    | V     |
| $I_{LED}$     | LED Current                    | 0.33 | 0.35 | 0.37  | A     |
| $I_{PP}$      | Required I Ripple              |      | 40   |       | mA    |
| Pout          | Output Power                   |      |      | 10.36 | W     |
| DIM_IN        | PWM Dimming                    | 0    |      | 100   | %     |
| OVP           | Output Over Voltage Protection |      | 30   |       | V     |
| <b>System</b> |                                |      |      |       |       |
| $F_{SW}$      | Switching Frequency            |      | 1    |       | MHz   |
| eff           | Efficiency                     |      | 80   |       | %     |
| $V_{DIODE}$   | Forward drop of schottky diode |      | 0.5  |       | V     |

Table 1. Design example parameters

**Design Example**

In this example, we will be designing a boost LED driver operating off a 12V input. This design has been created to drive 6 LEDs at 350mA with a ripple of about 20%. We are designing for 80% efficiency at a switching frequency of 1MHz.

**Select R<sub>ADJ</sub>**

Having chosen the LED drive current to be 350mA in this example, the current can be set by choosing the R<sub>ADJ</sub> resistor from Equation 1:

$$R_{ADJ} = \frac{0.2V}{0.35A} = 0.57\Omega$$

Use the next lowest standard value 0.56Ω.

$$I_{LED} = 0.36A$$

The power dissipation in this resistor is:

$$P_{RADJ} = I_{LED}^2 \times R_{ADJ} = 71mW$$

Use a resistor rated at quarter watt or higher.

**Operating Duty Cycle**

The operating duty cycle can be calculated using Equation four provided below:

$$Eq. (4) \quad D = \frac{(V_{OUT} - V_{IN} + V_{DIODE})}{V_{OUT} + V_{DIODE}}$$

V<sub>DIODE</sub> is the V<sub>f</sub> of the output diode D1 in the Typical Application. It is recommended to use a schottky diode because it has a lower V<sub>f</sub> than a junction diode.

These can be calculated for the nominal (typical) operating conditions, but should also be understood for the minimum and maximum system conditions as listed below.

$$D_{nom} = \frac{(V_{OUT(nom)} - V_{IN(nom)} + V_{DIODE})}{V_{OUT(nom)} + V_{DIODE}}$$

$$D_{max} = \frac{(V_{OUT(max)} - V_{IN(min)} + V_{DIODE})}{V_{OUT(max)} + V_{DIODE}}$$

$$D_{min} = \frac{(V_{OUT(min)} - V_{IN(max)} + V_{DIODE})}{V_{OUT(min)} + V_{DIODE}}$$

$$D_{nom} = \frac{(21 - 12 - 0.5)}{21 + 0.5} = 0.44$$

$$D_{nom} = \frac{(21 - 12 + 0.5)}{21 + 0.5} = 0.44$$

Therefore D<sub>nom</sub> = 44%, D<sub>max</sub> = 72% and D<sub>min</sub> = 15%.

**Inductor Selection**

First calculate the RMS input current (nominal, min and max) for the system given the operating conditions listed in the design example table. The minimum value of the RMS input current is necessary to ensure proper operation.

Using Equation 5, the following values have been calculated:

$$I_{IN\_RMS(max)} = \frac{V_{OUT(max)} \times I_{OUT(max)}}{eff \times V_{IN(min)}} = 1.54A_{(RMS)}$$

$$Eq (5) \quad I_{IN\_RMS(nom)} = \frac{V_{OUT(nom)} \times I_{OUT(nom)}}{eff \times V_{IN(nom)}} = 0.74A_{(RMS)}$$

$$I_{IN\_RMS(min)} = \frac{V_{OUT(min)} \times I_{OUT(min)}}{eff \times V_{IN(max)}} = 0.46A_{(RMS)}$$

I<sub>OUT</sub> is the same as I<sub>LED</sub>.

Selecting the inductor current (peak-to-peak), I<sub>L\_PP</sub>, to be between 20% to 50% of I<sub>IN\_RMS(nom)</sub>, in this case 40%, we obtain:

$$I_{L\_PP(nom)} = 0.4 \times I_{IN\_RMS(nom)} = 0.4 \times 0.74 = 0.30A_{P-P}$$

It can be difficult to find large inductor values with high saturation currents in a surface mount package. Due to this, the percentage of the ripple current may be limited by the available inductor. It is recommended to operate in the continuous conduction mode. The selection of L described here is for continuous conduction mode.

$$Eq. (6) \quad L = \frac{V_{IN} \times D}{I_{IN\_PP} \times F_{SW}}$$

Using the nominal values, we get:

$$L = \frac{12V \times 0.44}{0.3A \times 1MHz} = 18\mu H$$

Select the next higher standard inductor value of 22μH.

Going back and calculating the actual ripple current gives:

$$I_{IN\_PP(max)} = \frac{V_{IN(min)} \times D_{max}}{L \times F_{SW}} = \frac{8V \times 0.72}{22\mu H \times 1MHz} = 0.26A_{PP}$$

The average input current is different than the RMS input current because of the ripple current. If the ripple current is low, then the average input current nearly equals the RMS input current. In the case where the average input current is different than the RMS, equation 7 shows the following:

$$Eq. (7) \quad I_{IN\_AVE(max)} = \sqrt{(I_{IN\_RMS(max)})^2 - \frac{(I_{IN\_PP})^2}{12}}$$

$$I_{IN\_AVE(max)} = \sqrt{(1.54)^2 - \frac{(0.24)^2}{12}} \approx 1.54A$$

The Maximum Peak input current I<sub>L\_PK</sub> can found using Equation 8:

$$Eq. (8) \quad I_{L\_PK(max)} = I_{IN\_AVE(max)} + 0.5 \times I_{L\_PP(max)} = 1.67A$$

The saturation current (I<sub>SAT</sub>) at the highest operating temperature of the inductor must be rated higher than this.

The power dissipated in the inductor is:

$$\text{Eq. (9)} \quad P_{\text{INDUCTOR}} = I_{\text{IN\_RMS(max)}}^2 \times \text{DCR}$$

A Coilcraft # MSS1260-223ML is used in this example. Its DCR is 52mΩ, I<sub>SAT</sub> = 2.7A

$$P_{\text{INDUCTOR}} = 1.54^2 \times 52 \text{ m}\Omega = 0.123\text{W}$$

**Output Capacitor**

In this LED driver application, the I<sub>LED</sub> ripple current is a more important factor when compared to that of the output ripple voltage (although the two are directly related). To find the C<sub>OUT</sub> for a required I<sub>LED</sub> ripple use the following calculation:

For an output ripple I<sub>LED(ripple)</sub> = 20ma

$$\text{Eq. (10)} \quad C_{\text{OUT}} = \frac{I_{\text{LED(nom)}} \times D_{\text{nom}}}{I_{\text{LED(ripple)}} \times (R_{\text{ADJ}} + R_{\text{LED\_total}}) \times F_{\text{SW}}}$$

Find the equivalent ac resistance R<sub>LED\_ac</sub> from the datasheet of the LED. This is the inverse slope of the I<sub>LED</sub> vs. V<sub>f</sub> curve i.e.:

$$\text{Eq. (11)} \quad R_{\text{LED\_ac}} = \frac{\Delta V_f}{\Delta I_{\text{LED}}}$$

In this example use R<sub>LED\_ac</sub> = 0.6Ω for each LED.

If the LEDs are connected in series, multiply R<sub>LED\_ac</sub> = 0.6Ω by the total number of LEDs. In this example of six LEDs, we obtain the following:

$$R_{\text{LED\_total}} \equiv R_{\text{dynamic}} = 6 \times 0.6\Omega = 3.6\Omega$$

Eq. (12)

$$C_{\text{OUT}} = \frac{I_{\text{LED(nom)}} \times D_{\text{nom}}}{I_{\text{LED(ripple)}} \times (R_{\text{ADJ}} + R_{\text{LED\_total}}) \times F_{\text{SW}}} = 1.9\mu\text{F}$$

Use 2.2μF or higher.

There is a trade off between the output ripple and the rising edge of the DIM\_IN pulse. This is because between PWM dimming pulses, the converter stops pulsing and C<sub>OUT</sub> will start to discharge. The amount that C<sub>OUT</sub> will discharge depends on the time between PWM Dimming pluses. At the next DIM\_IN pulse, C<sub>OUT</sub> has to be charged up to the full output voltage V<sub>OUT</sub> before the desired LED current flows.

**Input Capacitor**

The input capacitor is shown in the Typical Application. For superior performance, ceramic capacitors should be used because of their low equivalent series resistance (ESR). The input capacitor C<sub>IN</sub> ripple current is equal to the ripple in the inductor. The ripple voltage across the input capacitor, C<sub>IN</sub> is the ESR of C<sub>IN</sub> times the inductor ripple. The input capacitor will also bypass the EMI generated by the converter as well as any voltage spikes generated by the inductance of the input line. For a required V<sub>IN(ripple)</sub>:

Eq. (13)

$$C_{\text{IN}} = \frac{I_{\text{IN\_PP}}}{V_{\text{IN(ripple)}} \times F_{\text{SW}}} = \frac{(0.3\text{A})}{8 \times 50\text{mV} \times 1\text{MHz}} = 0.75\mu\text{F}$$

This is the minimum value that should be used. To protect the IC from inductive spikes or any overshoot, a larger value of input capacitance may be required.

Use 2.2μF or higher as a good safe min.

**Rectifier Diode Selection**

A schottky diode is best used here because of the lower forward voltage and the low reverse recovery time. The voltage stress on the diode is the max V<sub>OUT</sub> and therefore a diode with a higher rating than max V<sub>OUT</sub> should be used. An 80% de-rating is recommended here as well.

$$\text{Eq. (14)} \quad I_{\text{DIODE(max)}} = I_{\text{OUT(max)}} = 0.36\text{A}$$

Since I<sub>IN\_AVE(max)</sub> occurs when D is at a maximum.

$$\text{Eq. (15)} \quad P_{\text{DIODE(max)}} \approx V_{\text{DIODE}} \times I_{\text{DIODE(max)}}$$

A SK35B is used in this example, it's V<sub>DIODE</sub> is 0.5V

$$P_{\text{DIODE(max)}} \approx 0.5\text{V} \times 0.36\text{A} = 0.18\text{W}$$

**MIC3223 Power Losses**

To find the power losses in the MIC3223:

There is about 6mA input from V<sub>IN</sub> into the V<sub>DD</sub> pin.

The internal power switch has an R<sub>DS\_ON</sub> of about 170mΩ at.

$$P_{\text{MIC3223}} = V_{\text{IN}} \times 6\text{mA} + P_{\text{wrFET}}$$

$$\text{Eq. (16)} \quad P_{\text{wrFET}} = I_{\text{FET\_RMS(max)}}^2 \times R_{\text{ds\_on\_@100}^\circ} + V_{\text{OUT(max)}} \times I_{\text{IN\_AVE(max)}} \times t_{\text{sw}} \times F_{\text{sw}}$$

$$R_{\text{ds\_on\_@100}^\circ} \approx 160\text{m}\Omega$$

t<sub>sw</sub> ≈ 30ns is the internal Power FET ON an OFF transition time.

$$I_{\text{SW\_RMS(max)}} = \sqrt{D \left( I_{\text{IN\_AVE(max)}}^2 + \frac{I_{\text{L\_PP}}^2}{12} \right)} = 1.3\text{A}$$

$$P_{\text{wrFET}} = 1.3\text{A}^2 \times 160\text{m}\Omega + 28\text{V} \times 1.54\text{A} \times 30\text{ns} \times 1\text{MHz} = 1.6\text{W}$$

$$P_{\text{MIC3223}} = 8 \times 6\text{mA} + 1.77\text{W} = 1.66\text{W}$$

**Snubber**

A snubber is a damping resistor in series with a DC blocking capacitor in parallel with the power switch (same as across the flyback diode because V<sub>OUT</sub> is an ac ground). When the power switch turns off, the drain to source capacitance and parasitic inductance will cause a high frequency ringing at the switch node. A snubber circuit as shown in the application schematic may be required if ringing is present at the switch node. A critically damped circuit at the switch node is where R equals the characteristic impedance of the switch node.



$$\text{Eq. (17)} \quad R_{\text{snubber}} = \sqrt{\frac{L_{\text{parasitic}}}{C_{\text{ds}}}}$$

The explanation of the method to find the best R snubber is beyond the scope of this data sheet.

Use  $R_{\text{snubber}} = 2\Omega$ , ½ watt and  $C_{\text{snubber}} = 470\text{pf}$  to  $1000\text{pf}$ .

The power dissipation in the  $R_{\text{snubber}}$  is:

$$P_{\text{snubber}} = C_{\text{snubber}} \times V_{\text{OUT}}^2 \times F_{\text{SW}}$$

$$P_{\text{snubber}} = 470\text{pF} \times 28\text{V}^2 \times 1\text{MHz} = 0.4\text{W}$$

|                                  |         |
|----------------------------------|---------|
| Power Loss in the L              | 0.123 W |
| Power Loss in the sckottky diode | 0.2 W   |
| $P_{\text{snubber}}$             | 0.4 W   |
| MIC3223 Power Loss               | 1.66 W  |
| Total Losses                     | 2.4W    |
| Efficiency                       | 80%     |

**Table 2. Major Power Losses**

Table 2 showing the Power losses in the Design Example.

**OVP - Over Voltage Protection**

Set OVP higher than the maximum output voltage by at least one Volt. To find the resistor divider values for OVP use equation 18 and set the OVP = 30V and  $R_{\text{OVP\_H}} = 100\text{k}\Omega$ :

$$\text{Eq. (18)} \quad R_{\text{OVP\_L}} = \frac{100\text{k}\Omega \times 1.245}{30 - 1.245} = 4.33\text{k}\Omega$$

**Compensation**

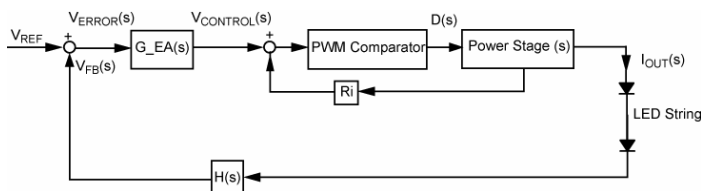

**Figure 9. Current Mode Loop Diagram**

Current mode control simplifies the compensation. In current mode, the complex poles created by the output L and C are reduced to a single pole. The explanation for this is beyond the scope of this datasheet, but it's generally thought to be because the inductor becomes a constant current source and can't act to change phase.

From the small signal block diagram the loop transfer function is:

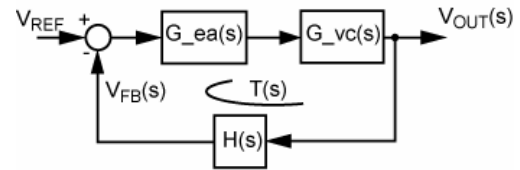

**Figure 10. Simplified Control Loop**

$$\text{Eq. (19)} \quad T(s) = G_{\text{ea}}(s) \times G_{\text{vc}}(s) \times H(s)$$

Where

$$\text{For a LED driver } H(s) = \frac{R_{\text{ADJ}}}{R_{\text{ADJ}} + R_{\text{dynamic}}}$$

$$G_{\text{ea}}(s) = g_m \left( Z_O \parallel \left( R_{\text{comp}} + \frac{1}{sC_{\text{comp}}} \right) \right)$$

Eq. (20)

$$G_{\text{VC}}(s) = \frac{V_{\text{OUT}}(s)}{V_{\text{CONTROL}}(s)}$$

$$= \left( \frac{1}{R_i} \right) \left( \frac{D'R_{\text{OP}}}{2} \right) \frac{\left( 1 - \frac{sL}{D'^2 R_{\text{dynamic}}} \right) (1 + sC_{\text{OUT}}R_{\text{ESR}})}{\left( 1 + \frac{sR_{\text{dynamic}}C_{\text{OUT}}}{2} \right)}$$

Where

$R_{\text{OP}} = \frac{V_{\text{OUT}}}{I_{\text{LED}}}$  Is the DC operating point of the converter.

$R_{\text{dynamic}}$  is the ac load the converter sees. When the load on the converter is a string of LEDs,  $R_{\text{dynamic}}$  is the series sum of the  $R_{\text{LED(ac)}}$  of each LED.

$R_{\text{LED\_total}}$  is usually between  $0.1\Omega$  to  $1\Omega$  per LED. It can be calculated from the slope of  $I_{\text{LED}}$  vs.  $V_f$  plot of the LED.

$$R_i = A_i \times R_{\text{cs}} = 0.86\Omega$$

$A_i = 114$  and  $R_{\text{cs}} \approx 7.5\text{m}\Omega$ ; are internal to the ic.

The equation for  $G_{\text{vc}}(s)$  is theoretical and should give a good idea of where the poles and zeros are located.

$$\text{Eq. (20) shows that } s = \frac{D'^2 R_{\text{dynamic}}}{L} \rightarrow f_{\text{RHPZ}} = \frac{D'^2 R_{\text{dynamic}}}{2\pi L}$$

is a RHP Zero. The loop bandwidth should be about 1/5 to 1/10 of the frequency of  $R_{\text{HPZ}}$  to ensure stability. From Equation (20) it is shown that there is only the single pole.

$$s = \frac{1}{R_{\text{dynamic}}C_{\text{OUT}}} \rightarrow f_{\text{pole}} = \frac{1}{2\pi R_{\text{dynamic}}C_{\text{OUT}}}$$

and a Zero due to the ESR of the output capacitor.

$$s = \frac{1}{R_{\text{ESR}}C_{\text{OUT}}} \rightarrow f_{\text{ESR}} = \frac{1}{2\pi R_{\text{ESR}}C_{\text{OUT}}}$$

This greatly simplifies the compensation.

One needs only to get a bode plot of the transfer function of the control to output  $G_{vc}(s)$  with a network analyzer and/or calculate it. From the bode plot find what the gain of

$G_{vc}(s)$  is at  $f = \frac{R_{HPZ}}{10}$ . Next design the error amp gain

$G_{ea}(s)$  so the loop gain at the cross over frequency  $T(f_{co})$  is

0 db where  $f_{co} = \frac{R_{HPZ}}{10}$  or less.

**Error Amp**

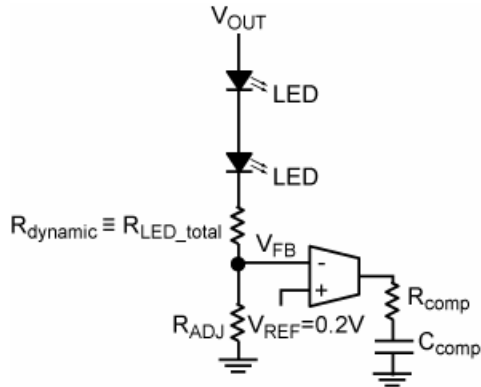

**Figure 11. Internal Error Amp and External Compensation**

The error amp is a gm type and the gain  $G_{ea}(s)$  is

$$\text{Eq. (21)} \quad G_{ea}(s) = g_m \left( Z_o \parallel \left( R_{comp} + \frac{1}{sC_{comp}} \right) \right)$$

$$g_m = \frac{0.8\text{mA}}{V} \text{ and } Z_o = 1.2\text{M}\Omega.$$

$$\text{The zero is } f_{zero} = \frac{1}{2R_{comp}C_{comp}} = \frac{f_{co}}{10} = \frac{R_{HPZ}}{100}.$$

**Error Amp Gain and Phase**

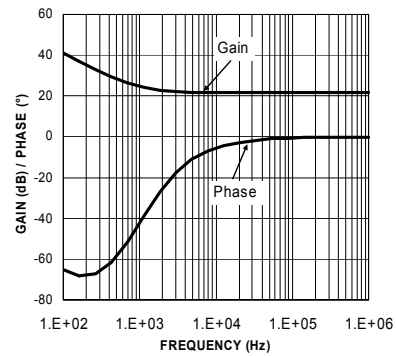

Set the  $f_{co}$  at the mid band where  $G_{ea}(f_{co}) = g_m \times R_{comp}$ . At  $f_{zero} \times 10$  the phase boost is near its maximum.

**Figure 12. Error Amp Transfer Function**

## Other Applications

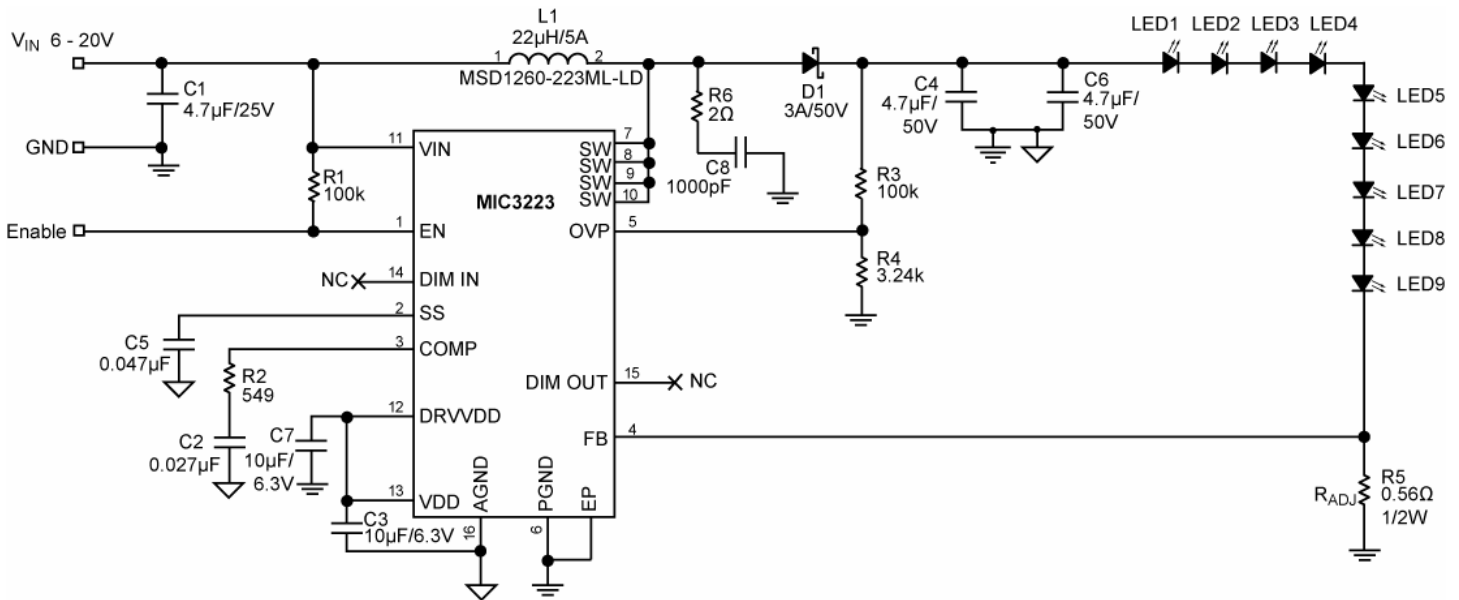

Figure 13. MIC3223 Typical Application without External PWM Dimming Switch

### Audio noise

Audio noise from the output capacitors may exist in a standard boost LED converter. The physical dimensions of ceramic capacitors change with the voltage applied to them. During PWM Dimming, the output capacitors in standard converters are subjected to fast voltage and current transients that may cause the output capacitors to oscillate at the PWM Dimming frequency. This is one reason users may want PWM dimming frequencies above the audio range.

### PCB Layout

1. All typologies of DC-to-DC converters have a Reverse Recovery Current (RRC) of the flyback or (freewheeling) diode. Even a Schottky diode, which is advertised as having zero RRC, it really is not zero. The RRC of the freewheeling diode in a boost converter is even greater than in the Buck converter. This is because the output voltage is higher than the input voltage and the diode has to charge up to  $-V_{OUT}$  during each on-time pulse and then discharge to  $V_f$  during the off-time.

2. Even though the RRC is very short (tens of nanoseconds) the peak currents are high (multiple amperes). These fast current spikes generate EMI (electromagnetic interference). The amount of RRC is related to the die size and internal capacitance of the diode. It is important not to oversize (i.e. not more than the usual de rating) the diode because the RRC will be needlessly higher. Example: If a 2A diode is needed do not use a higher current rated diode because the RRC will be needlessly higher. If a 25V diode is needed do not use a 100V etc.
3. The high RRC causes a voltage drop on the ground trace of the PCB and if the converter control IC is referenced to this voltage drop, the output regulation will suffer.
4. For good output regulation, it is important to connect the IC's reference to the same point as the output capacitors to avoid the voltage drop caused by RRC. This is also called a star connection or single point grounding.
5. Feedback trace: The high impedance traces of the FB should be short.

### Evaluation Board Schematic

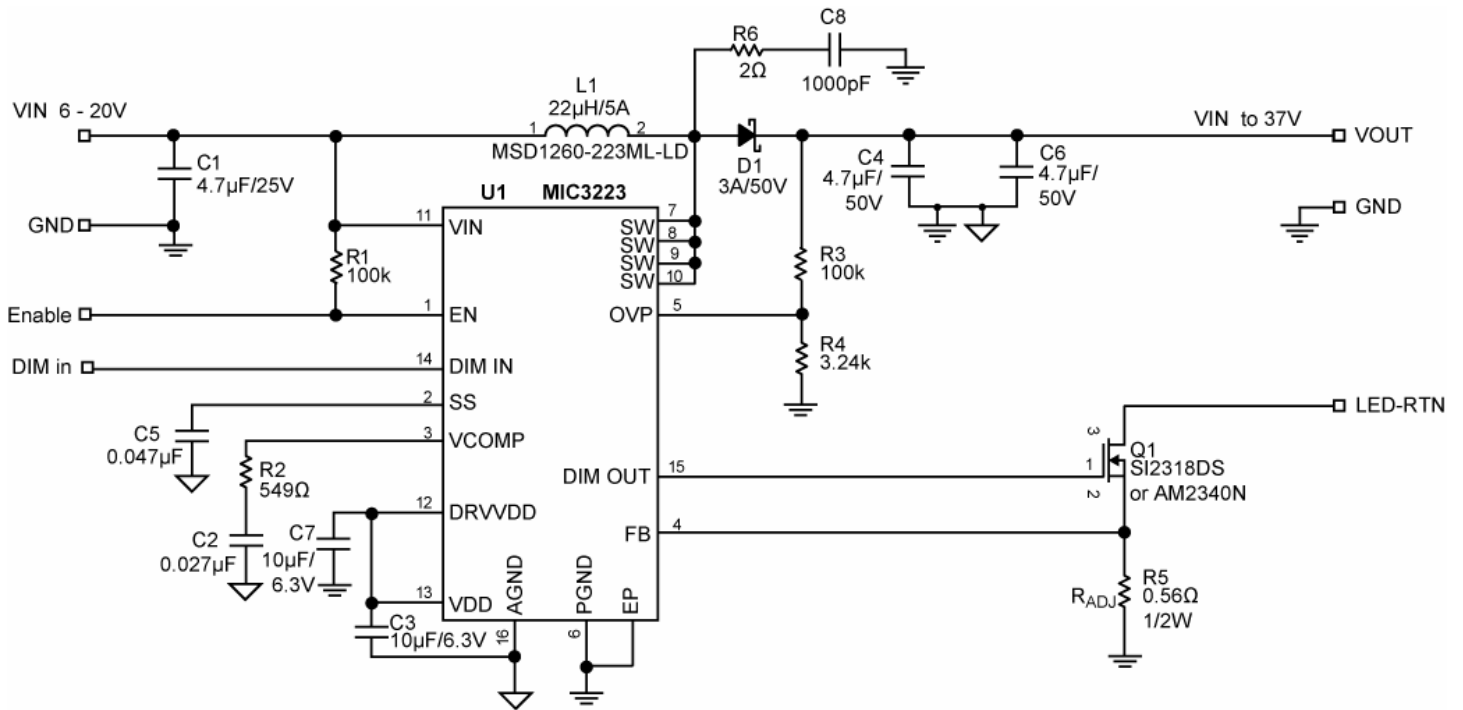

37V Max 1A LED Driver

**Bill of Materials**

| Item      | Part Number        | Manufacturer                               | Description   | Qty      |
|-----------|--------------------|--|---|----------|
| C1        | GRM319R61E475KA12D | muRata <sup>(1)</sup>                      | Ceramic Capacitor, 4.7 $\mu$ F, 25V, Size 1206, X7R   | 1        |
|           | C3216X7R1E475M     | TDK <sup>(2)</sup>                         |   |          |
|           | 12063D475KAT2A     | AVX <sup>(3)</sup>                         |   |          |
| C2        | GRM188R71C273KA01D | muRata                                     | Ceramic Capacitor, 0.027 $\mu$ F, 6.3V, Size 0603, X7R  | 1        |
| C3, C7    | GRM188R60J106ME47D | muRata                                     | Ceramic Capacitor, 10 $\mu$ F, 6.3V, Size 0603, X7R   | 2        |
|           | C1608X5R0J106K     | TDK  |   |          |
|           | 08056D106MAT2A     | AVX  |   |          |
| C4, C6    | 12105C475KAZ2A     | AVX  | Ceramic Capacitor, 4.7 $\mu$ F, 50V, Size 1210, X7R   | 2        |
|           | GRM32ER71H475KA88L | muRata                                     |   |          |
| C5        | GRM188R71C473KA01D | muRata                                     | Ceramic Capacitor, 0.047 $\mu$ F, 6.3V, Size 0603, X7R  | 1        |
|           | 0603YC473K4T2A     | AVX  |   |          |
| C8        | GRM188R72A102KA37D | muRata                                     | Ceramic Capacitor, 1000pF, 100V Size 0603, X7R  |          |
| D1        | SK35B              | MCC <sup>(4)</sup>                         | Schottky Diode, 3A, 50V (SMB)   | 1        |
| L1        | MSD1260-223ML-LD   | Coilcraft <sup>(6)</sup>                   | Inductor, 22 $\mu$ H, 5A  | 1        |
| R1, R3    | CRCW0603100KFKEA   | Vishay Dale <sup>(4)</sup>                 | Resistor, 100k, 1%, Size 0603   | 2        |
| R2        | CRCW0603549RFKEA   | Vishay Dale                                | Resistor, 549 $\Omega$ , 1%, Size 0603  | 1        |
| R4        | CRCW06033K24FKEA   | Vishay Dale                                | Resistor, 3.24k, 1%, Size 0603  | 1        |
| R5        | CRCW1206R560FKEA   | Vishay Dale                                | Resistor, 0.56 $\Omega$ , 1%, 1/2W, Size 1206<br>(for .35A LED current Change for different ILED) | 1        |
| R6        | RMC 1/4 2 1% R     | Stackpole Electronics, Inc. <sup>(7)</sup> | Resistor, 2 $\Omega$ , 1%, 1/2W, Size 1210  | 1        |
| Q1        | Si2318DS           | Vishay Siliconix <sup>(4)</sup>            | N-Channel 40V MOSFET  | 1        |
|           | AM2340N            | Analog Power <sup>(8)</sup>                |   |          |
| <b>U1</b> | <b>MIC3223</b>     | <b>Micrel, Inc.<sup>(9)</sup></b>          | <b>High Power Boost LED Driver with Integrated FET</b>  | <b>1</b> |

**Notes:**

1. Murata: [www.murata.com](http://www.murata.com).
2. TDK: [www.tdk.com](http://www.tdk.com).
3. AVX: [www.avx.com](http://www.avx.com).
4. Vishay: [www.vishay.com](http://www.vishay.com).
5. Internacional Rectifier: [www.ift.com](http://www.ift.com).
6. Coilcraft: [www.coilcraft.com](http://www.coilcraft.com)
7. Stackpole Electronics, Inc.: [www](http://www.stackpole.com).
8. Analog Power: [www.analogpowerinc.com](http://www.analogpowerinc.com)
8. **Micrel, Inc.:** [www.micrel.com](http://www.micrel.com).

### PCB Layout Recommendations

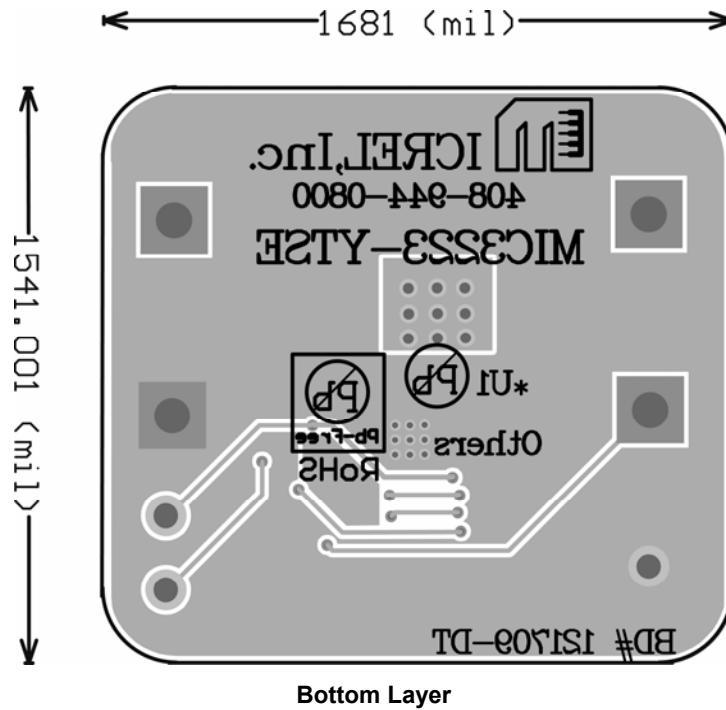
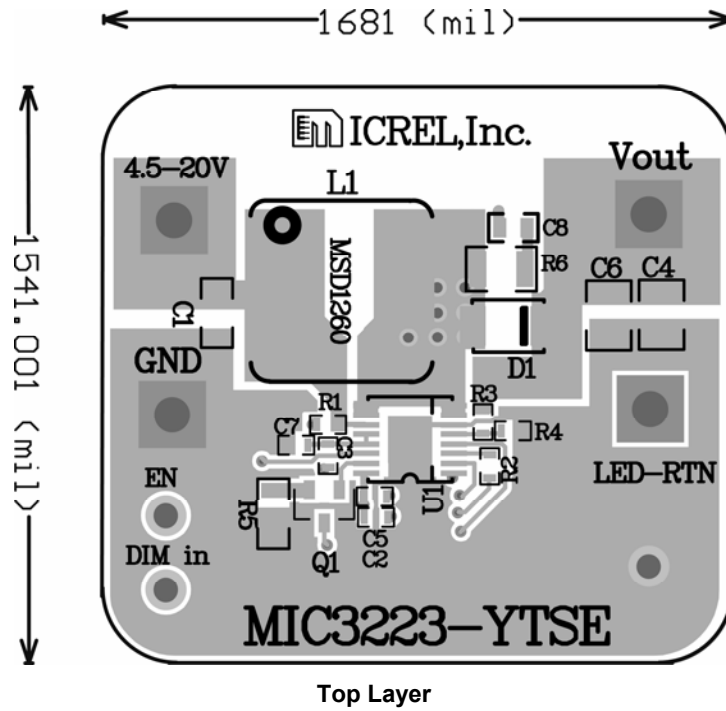

# Package Information

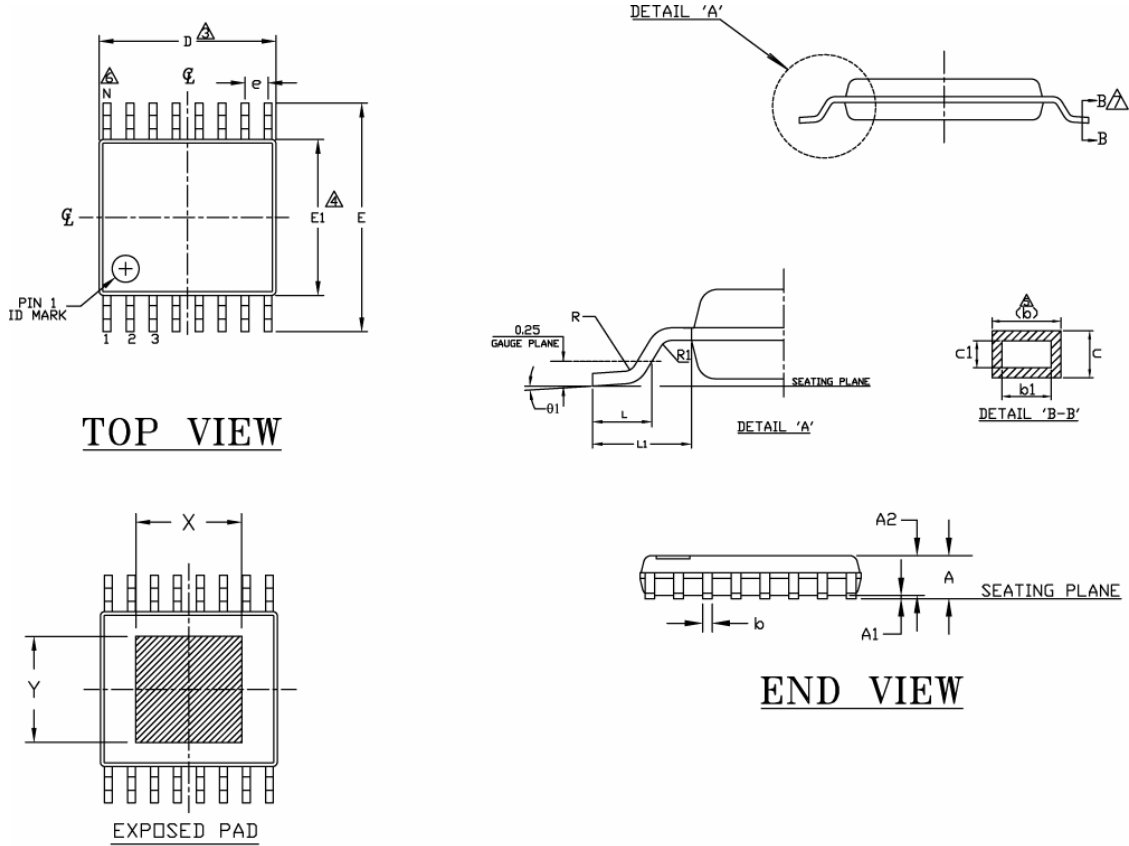

**TOP VIEW**

**BOTTOM VIEW**

**END VIEW**

| SYMBOL  | 14L TSSOP<br>Thermally Enhanced         |            |            | 16L TSSOP<br>Thermally Enhanced       |            |            |
|---------|---|------------|------------|---------------------------------------|------------|------------|
|         | MIN                                     | NOM.       | MAX        | MIN                                   | NOM.       | MAX        |
| A       | —                                       | —          | 1.20       | —                                     | —          | 1.20       |
| A1      | 0.025                                   | —          | 0.100      | 0.025                                 | —          | 0.100      |
| A2      | 0.80                                    | 0.90       | 1.05       | 0.80                                  | 0.90       | 1.05       |
| D       | 4.9                                     | 5.0        | 5.1        | 4.9                                   | 5.0        | 5.1        |
| E1      | 4.3                                     | 4.4        | 4.5        | 4.3                                   | 4.4        | 4.5        |
| E       | 6.2                                     | 6.4        | 6.6        | 6.2                                   | 6.4        | 6.6        |
| L       | 0.45                                    | 0.60       | 0.75       | 0.45                                  | 0.60       | 0.75       |
| R       | 0.09                                    | —          | —          | 0.09                                  | —          | —          |
| R1      | 0.09                                    | —          | —          | 0.09                                  | —          | —          |
| b       | 0.19                                    | —          | 0.30       | 0.19                                  | —          | 0.30       |
| b1      | 0.19                                    | 0.22       | 0.25       | 0.19                                  | 0.22       | 0.25       |
| c       | 0.09                                    | —          | 0.20       | 0.09                                  | —          | 0.20       |
| c1      | 0.09                                    | —          | 0.16       | 0.09                                  | —          | 0.16       |
| Ø1      | 0*                                      | —          | 8*         | 0*                                    | —          | 8*         |
| L1      | 1.0 REF                                 |            |            | 1.0 REF                               |            |            |
| e       | 0.65 BSC                                |            |            | 0.65 BSC                              |            |            |
| N       | 14                                      |            |            | 16                                    |            |            |
| Ref.    | Jedec MO-153 Issue C<br>Variation ABT-1 |            |            | Jedec MO-153 Issue C<br>Variation ABT |            |            |
| EP Area | Pad Size<br>Up 1                        | X<br>2.997 | Y<br>3.200 | Pad Size<br>Up 1                      | X<br>2.997 | Y<br>2.997 |

**Notes**

1. ALL DIMENSIONS ARE IN MILLIMETERS (ANGLES IN DEGREES).
2. DIMENSIONING AND TOLERANCING PER ANSI Y14.5M-1982.
3. DIMENSION 'D' DOES NOT INCLUDE MOLD FLASH, PROTRUSIONS OR GATE BURRS.
4. DIMENSION 'E1' DOES NOT INCLUDE INTERNAL FLASH OR PROTRUSION.
5. DIMENSION 'b' DOES NOT INCLUDE DAMBAR PROTRUSION.
6. DIMENSION 'N' IS THE MAXIMUM NUMBER OF LEAD TERMINAL POSITIONS FOR THE SPECIFIED PACKAGE LENGTH.
7. CROSS SECTION B-B TO BE DETERMINED AT 0.10 TO 0.25MM FROM THE LEAD TIP.
8. EXPOSED PAD WILL BE DEPEND ON THE PAD SIZE OF THE L/F.

**16-Pin ePad TSSOP (TSE)**

## Recommended Land Pattern

LP # TSSOPEP-16LD-LP-1  
 All units are in mm  
 Tolerance  $\pm 0.05$  if not noted

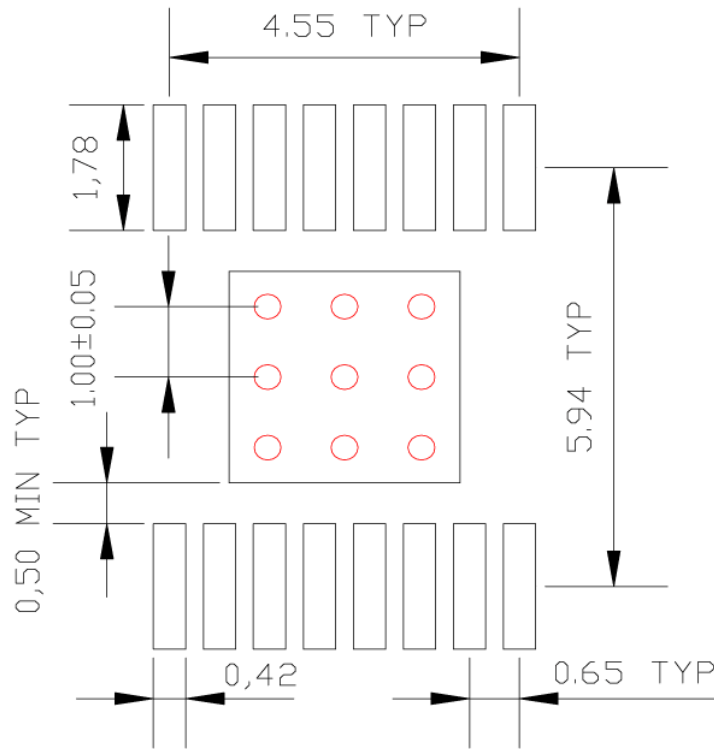

Red circle indicates Thermal Via. Size should be .300-.350 mm in diameter and it should be connected to GND plane for maximum thermal performance.

**MICREL, INC. 2180 FORTUNE DRIVE SAN JOSE, CA 95131 USA**  
 TEL +1 (408) 944-0800 FAX +1 (408) 474-1000 WEB <http://www.micrel.com>

The information furnished by Micrel in this data sheet is believed to be accurate and reliable. However, no responsibility is assumed by Micrel for its use. Micrel reserves the right to change circuitry and specifications at any time without notification to the customer.

Micrel Products are not designed or authorized for use as components in life support appliances, devices or systems where malfunction of a product can reasonably be expected to result in personal injury. Life support devices or systems are devices or systems that (a) are intended for surgical implant into the body or (b) support or sustain life, and whose failure to perform can be reasonably expected to result in a significant injury to the user. A Purchaser's use or sale of Micrel Products for use in life support appliances, devices or systems is a Purchaser's own risk and Purchaser agrees to fully indemnify Micrel for any damages resulting from such use or sale.

© 2009 Micrel, Incorporated.