



FEATURES

- 50 WATTS MAXIMUM OUTPUT POWER
- SINGLE OUTPUT UP TO 20A
- COMPACT 2.28 X 1.45 X 0.50 INCH PACKAGE
- HIGH EFFICIENCY UP TO 91%
- 2:1 WIDE INPUT VOLTAGE RANGE
- FIXED SWITCHING FREQUENCY
- INDUSTRY STANDARD FOOTPRINT
- NO MINIMUM LOAD
- ADJUSTABLE OUTPUT VOLTAGE
- UNDER-VOLTAGE LOCKOUT
- INPUT TO OUTPUT ISOLATION (BASIC INSULATION)
- CE MARK MEETS 2006/95/EC, 93/68/EEC AND 2004/108/EC
- UL60950-1, EN60950-1 AND IEC60950-1 LICENSED
- ISO9001 CERTIFIED MANUFACTURING FACILITIES
- COMPLIANT TO RoHS EU DIRECTIVE 2002/95/EC

APPLICATIONS

Wireless Network
Telecom/Datacom
Industry Control System
Distributed Power Architectures
Semiconductor Equipment

OPTIONS

Positive logic Remote on/off, Pin length

DESCRIPTION

QEB50 single output DC/DC converters provide up to 50 watts of output power in an industry standard quarter-brick package and footprint. These units are specifically designed to meet the power needs of low-voltage silicon. All models feature a wide input range, trimmable output voltage and a 20A current rating.

TECHNICAL SPECIFICATION All specifications are typical at nominal input, full load and 25°C otherwise noted

OUTPUT SPECIFICATIONS		
Output power		50 Watts, max.
Voltage accuracy	Full load and Normal Vin	± 1.5%
Minimum load		0%
Voltage adjustability	(Note 5)	+ 10% , -20%
Line regulation	LL to HL at Full Load	±0.2%
Load regulation	No load to Full Load	See table
Remote Sense	(Note 5)	10% of Vout
Ripple and noise	20MHz bandwidth (Measured with a 1µF M/C and a 10µFT/C)	See table
Temperature coefficient		±0.02% / °C, max.
Transient response recovery time	25% load step change	200µS
Over voltage Protection threshold (Non-latching Hiccup)		120% Vout max.
Over Current Protection threshold		110% ~ 140% of Iout Rated
Short circuit protection		Hiccup, automatics recovery
GENERAL SPECIFICATIONS		
Efficiency		See table
Isolation voltage	Input to Output Input to Case Output to Case	1600VDC, min. 1000VDC, min. 1000VDC, min.
Isolation resistance		10 ⁷ ohms, min.
Isolation capacitance		2500 pF, max.
Switching frequency		270 KHz, typ.
Approvals and standard		IEC60950-1, UL60950-1, EN60950-1
Case material		Aluminum base plate
Weight (approx)		42g (1.46 oz)
MTBF (Note 1)	BELLCORE TR-NWT-000332 MIL-HDBK-217F	2.500 x 10 ⁶ hrs 3.568 x 10 ⁵ hrs

INPUT SPECIFICATIONS		
Input voltage range	24V nominal input 48V nominal input	18 – 36VDC 36 – 75VDC
Input filter		L-C type
Input surge voltage 100ms max	24V nominal input 48V nominal input	50VDC 100VDC
Start up time	Nominal Vin and constant resistive load	Power up Remote ON/OFF 25mS, typ. 25mS, typ.
Start-up voltage	24V nominal input 48V nominal input	17VDC 34VDC
Shutdown voltage	24V nominal input 48V nominal input	15VDC 32VDC
Remote ON/OFF (Note 6)		
Negative logic(Standard)	DC-DC ON DC-DC OFF	Short or 0V < Vr < 1.2V Open or 3V < Vr < 15V
Positive logic(OPTION)	DC-DC ON DC-DC OFF	Open or 3V < Vr < 15V Short or 0V < Vr < 1.2V
Input current of remote control pin	Nominal Vin	-0.5~1.0mA
Remote off state input current	Nominal Vin	2.5mA
ENVIRONMENTAL SPECIFICATIONS		
Operating base-plate temperature range (Note 7)		-40°C to +100°C (with derating)
Over temperature protection		110°C, typ.
Storage temperature range		-55°C to +125°C
Thermal shock		MIL-STD-810F
Vibration		MIL-STD-810F
Humidity , Max , Non-Condensing		95%
EMC CHARACTERISTICS		
EMI (Note 8)	EN55022	Class A
Radiated immunity	EN61000-4-3	10 V/m Perf. Criteria A
Fast transient (Note 9)	EN61000-4-4	± 2KV Perf. Criteria B
Surge (Note 9)	EN61000-4-5	± 1KV Perf. Criteria B
Conducted immunity	EN61000-4-6	10 Vr.m.s Perf. Criteria A



Model Number	Input Range	Output Voltage	Output Current		Output ⁽⁴⁾ Ripple & Noise	Input Current		Eff ⁽⁴⁾ (%)	Load regulation
			Min. load	Full load		No load ⁽³⁾	Full load ⁽²⁾		
QEB50-24S3P3	18 – 36 VDC	3.3 VDC	0mA	15A	100mVp-p	70mA	2398mA	90	10mV
QEB50-24S05	18 – 36 VDC	5 VDC	0mA	10A	100mVp-p	120mA	2394mA	91	15mV
QEB50-24S12	18 – 36 VDC	12 VDC	0mA	4.17A	100mVp-p	180mA	2413mA	91	36mV
QEB50-24S15	18 – 36 VDC	15 VDC	0mA	3.33A	100mVp-p	180mA	2392mA	91	45mV
QEB50-48S1P8	36 – 75 VDC	1.8 VDC	0mA	20A	100mVp-p	55mA	904mA	87	5.4mV
QEB50-48S2P5	36 – 75 VDC	2.5 VDC	0mA	20A	100mVp-p	55mA	1240mA	88	7.5mV
QEB50-48S3P3	36 – 75 VDC	3.3 VDC	0mA	15A	100mVp-p	70mA	1199mA	90	10mV
QEB50-48S05	36 – 75 VDC	5 VDC	0mA	10A	100mVp-p	65mA	1197mA	91	15mV
QEB50-48S12	36 – 75 VDC	12 VDC	0mA	4.17A	100mVp-p	120mA	1207mA	91	36mV
QEB50-48S15	36 – 75 VDC	15 VDC	0mA	3.33A	100mVp-p	120mA	1196mA	91	45mV

Note :

- 1.BELLCORE TR-NWT-000332. Case 1: 80% Stress, Temperature at 40°C.
MIL-HDBK-217F Notice2 @Ta=25 °C, Full load(Ground, Benign, controlled environment)
- 2.Maximum value at nominal input voltage and full load of standard type.
- 3.Typical value at nominal input voltage and no load.
- 4.Typical value at nominal input voltage and full load.
- 5.Maximum output deviation is 10% inclusive of trim. If remote sense is not being used, the + sense should be connected to its corresponding +OUTPUT and likewise the –sense should be connected to its corresponding –OUTPUT.
- 6.The positive logic and pin length are optional (see table). The pin voltage is referenced to –Vin.
- 7.Heat sink is optional and P/N : 7G-0029A-F, 7G-0030A-F, 7G-0031A-F, 7G-0032A-F.
- 8.The QEB50 meets EN55022 class A and class B only with external components connected before the input pin to the converter.
- 9.An external input filter capacitor is required if the module has to meet EN61000-4-4, EN61000-4-5.
The filter capacitor Power Mate suggest: Nippon chemi-con KY series, 220µF/100V, ESR 48mΩ.
- 10.BASEPLATE GROUNDING : Base-plate should be grounded at one of the four screw bolts prior to operation.
- 11.The converter is provided by basic insulation.



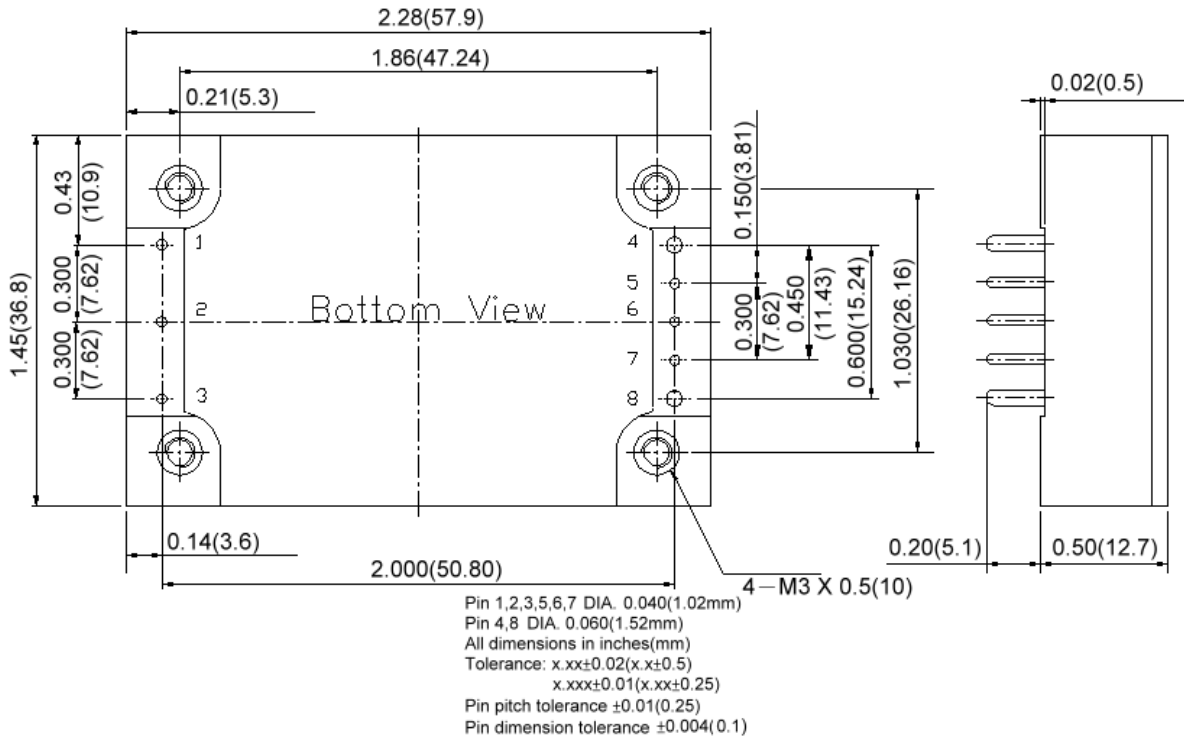

PIN CONNECTION	
PIN	Define
1	- INPUT
2	ON/OFF
3	+ INPUT
4	- OUTPUT
5	- SENSE
6	TRIM
7	+ SENSE
8	+ OUTPUT

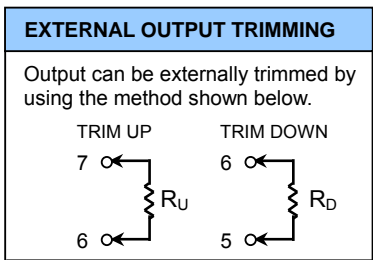

PRODUCT OPTIONS TABLE	
Option	Suffix
Negative remote ON/OFF logic, 0.20" pin length (standard)	-
Negative remote ON/OFF logic, 0.145" pin length	-L
Negative remote ON/OFF logic, 0.11" pin length	-K
Positive remote ON/OFF logic, 0.20" pin length	-P
Positive remote ON/OFF logic, 0.145" pin length	-S
Positive remote ON/OFF logic, 0.11" pin length	-M

Example : QEB50-48S3P3-P



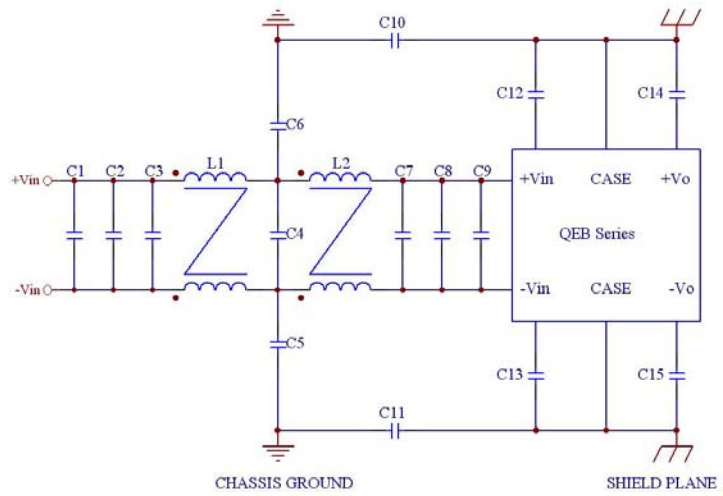
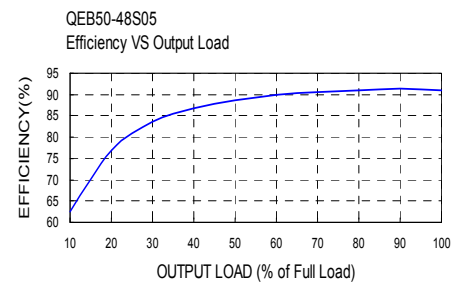
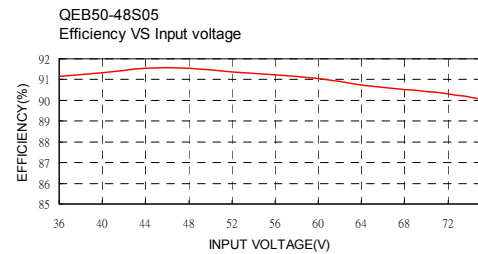
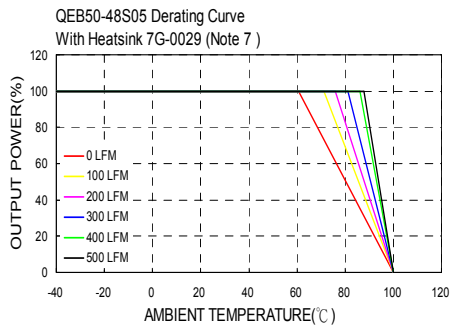
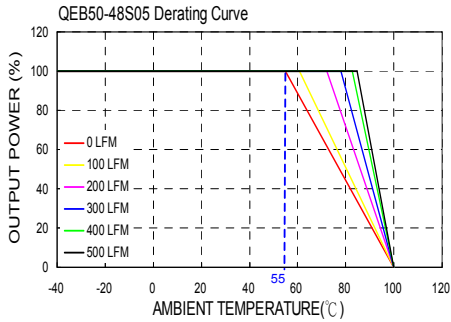

Recommended Filter for EN5022 Class B Compliance

The components used in the above figure, together with the manufacturers' part numbers for these components, are as follows:

	C1	C2	C3	C4	C5
QEB50-24Sxx	N/A	N/A	6.8μF/50V	6.8μF/50V	1.5nF/3KV
	C6	C7	C8	C9	C10
	1.5nF/3KV	6.8μF/50V	6.8μF/50V	6.8μF/50V	0.1μF/50V
	C11	C12	C13	C14	C15
	0.1μF/50V	1.0nF/3KV	1.0nF/3KV	1.0nF/3KV	1.0nF/3KV
	L1	L2			
	620μH	620μH			

	C1	C2	C3	C4	C5
QEB50-48Sxx	100μF/100V	1.5μF/100V	1.5μF/100V	1.5μF/100V	1.5nF/3KV
	C6	C7	C8	C9	C10
	1.5nF/3KV	47μF/100V	1.5μF/100V	1.5μF/100V	0.1μF/50V
	C11	C12	C13	C14	C15
	0.1μF/50V	1.0nF/3KV	1.0nF/3KV	1.0nF/3KV	1.0nF/3KV
	L1	L2			
	620μH	620μH			

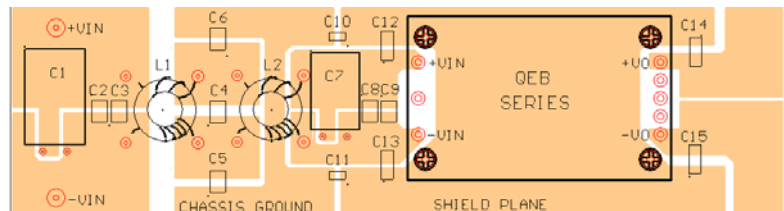

Recommended EN5022 Class B Filter Circuit Layout

