

IL494

PWM Control Circuit

The IL494 incorporates on a single monolithic chip all the functions required in the construction of a pulse-width-modulation control circuit. Designed primarily for power supply control, the IL494 contains an on-chip 5-volt regulator, two error amplifiers, adjustable oscillator, dead-time control comparator, pulse-steering flip-flop, and output-control circuitry. The uncommitted output transistors provide either common-emitter or emitter-follower output capability. Push-pull or single-ended output operation may be selected through the output-control function. The architecture of the IL494 prohibits the possibility of either output being pulsed twice during push-pull operation.

- Complete PWM Power Control Circuitry
- Uncommitted Outputs for 200 mA Sink or Source
- Output Control Selects Single-Ended or Push-Pull Operation
- Internal Circuitry Prohibits Double Pulse at Either Output
- Internal Regulator Provides a Stable 5 V Reference Supply
- Variable Dead-Time Provides Control Over Total Range

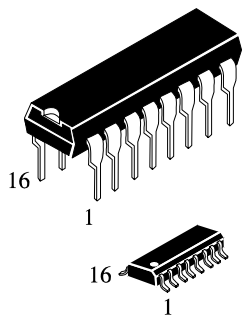

N SUFFIX PLASTIC
D SUFFIX SOIC

ORDERING INFORMATION
IL494N Plastic
IL494D SOIC
T_A = -20°C to 85°C for all packages

FUNCTION TABLE

Output Control	Output Function
Grounded	Single-ended or Parallel Output
At V _{ref}	Normal Push-Pull Operation

PIN ASSIGNMENT

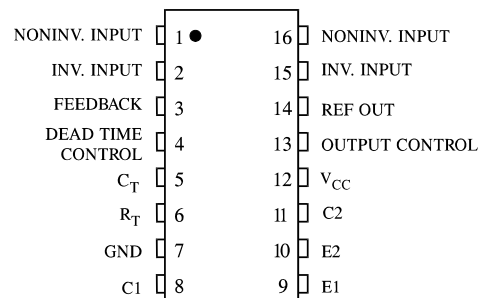

LOGIC DIAGRAM

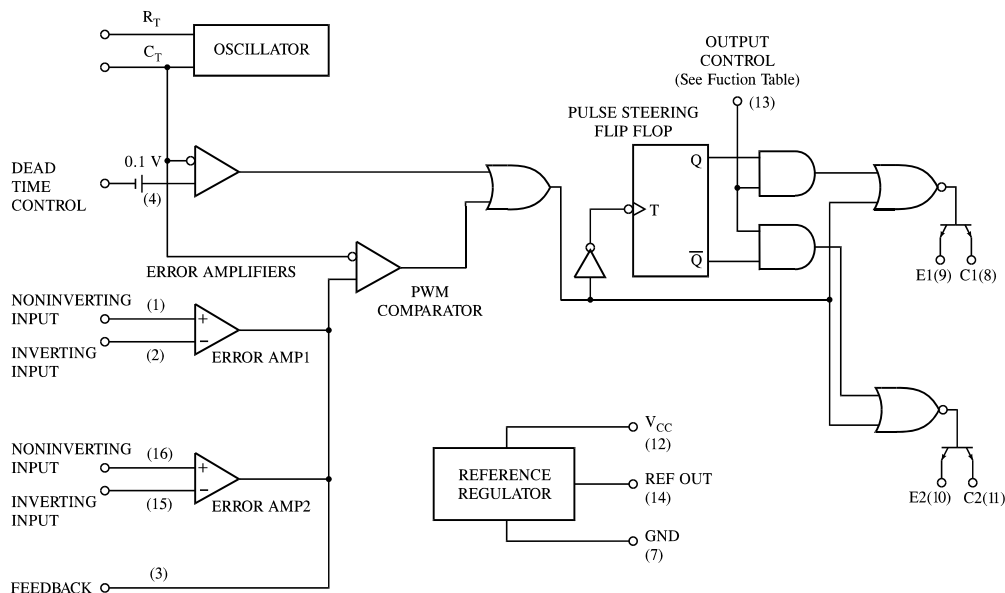

MAXIMUM RATINGS

Symbol	Parameter	Value	Unit
V _{CC}	Supply Voltage	41	V
V _I	Amplifier Input Voltage	V _{CC} +0.3	V
V _O	Collector Output Voltage	41	V
	Collector Output Current	250	mA
T _{stg}	Storage Temperature	-65 to +150	°C

RECOMMENDED OPERATING CONDITIONS

Symbol	Parameter	Min	Max	Unit
V _{CC}	Supply Voltage	7	40	V
V _I	Amplifier Input Voltage	-0.3	V _{CC} - 2	V
V _O	Collector Output Voltage		40	V
	Collector Output Current (Each Transistor)		200	mA
	Current Into Feed back Terminal		0.3	mA
C _T	Timing Capacitor	0.47	10.000	nF
R _T	Timing Resistor	1.8	500	KΩ
	Oscillator Frequency	1	300	KHz
T _A	Operating Free-Air Temperature	-20	+85	°C

ELECTRICAL CHARACTERISTICS (Temperature -20 ~ 85°C, V_{CC} = 15 V, f=10 kHz)

Symbol	Parameter	Test Conditions	Min	Max	Unit
Reference Section					
V _{ref}	Output Voltage	I _O =1 mA	4.90	5.10	V
V _{regin}	Output regulation	V _{CC} =7 V to 40 V, T _A =25°C		25	mV
V _{regout}	Input regulation	I _O =1 to 10 mA, T _A =25°C		15	mV
ΔV _{ref}	Output Voltage change with temperature	T _A = -20°C to 85°C		1	%
I _{SC}	Short-circuit output current (Note 1)	V _{ref} =0		50	mA
Oscillator Section					
f _{OSC}	Frequency	C _T =0.01 μF, R _T =12 kΩ	6	14	KHz
δf _{OSC}	Standard deviation of frequency (Note 2)	All values of V _{CC} , C _T , R _T , T _A Constant		15	%
δf _{OSC(ΔV)}	Frequency change with voltage	V _{CC} = 7 V to 40 V, T _A =25°C		10	%
δf _{OSC(ΔT)}	Frequency change with temperature	C _T =0.01 μF, R _T =12 kΩ T _A = -20°C to 85°C		2	%
Dead Time Control Section					
I _{IB(2T)}	Input bias current (pin 4)	V _I = 0 to 5.25 V		-10	μA
DC _{max}	Maximum duty cycle, each output	V _{I(pin 4)} =0 V	45		%
V _{THD}	Input threshold voltage (pin 4)	Zero duty cycle		3.3	V
		Maximum duty cycle	0		
Error Amp Section					
V _{IO}	Input offset voltage	V _{O(pin 3)} =2.5 V		10	mV
I _{IO}	Input offset current	V _{O(pin 3)} =2.5 V		250	nA
I _{IB}	Input bias current	V _{O(pin 3)} =2.5 V		1	μA
	Common-mode input voltage range	V _{CC} = 7 V to 40 V	LOW	-0.3	V
			HIGH	V _{CC} - 2	
A _{vol}	Open-loop voltage amplification	ΔV _O =3 V, V _O =0.5 to 3.5 V	70		dB
f _b	Unity-gain bandwidth		100		kHz
CMRR	Common-mode rejection ratio	V _{CC} =40 V, T _A =25°C	65		dB
I _O	Output sink current (pin 3)	V _{ID} =-15 mV to -5 V, V _{O(pin 3)} =0.7 V	0.3		mA
I _{O+}	Output source current (pin 3)	V _{ID} =15 mV to 5 V, V _{O(pin 3)} =3.5 V	-2		mA

ELECTRICAL CHARACTERISTICS (Temperature -20 ~ 85°C, V_{CC} = 15 V, f=10 kHz)

Symbol	Parameter	Test Conditions	Min	Max	Unit
PWM Comparator Section					
V _{THP}	Input threshold voltage (pin 3)	Zero duty cycle		4.5	V
I _I	Input sink current (pin 3)	V _{O(pin 3)} =0.7 V	0.3		mA
Switching Characteristics					
t _{rc}	Output voltage rise time	Common-emitter configuration		200	ns
t _{fc}	Output voltage fall time	Common-emitter configuration		100	ns
t _{rf}	Output voltage rise time	Emitter-follower configuration		200	ns
t _{ff}	Output voltage fall time	Emitter-follower configuration		100	ns
Output Section					
I _{C(off)}	Collector off-state current	V _{CE} =40 V, V _{CC} =40 V		100	μA
I _{E(off)}	Emitter off-state current	V _{CC} =V _C =40 V, V _E =0		-100	μA
V _{SAT}	Collector-emitter saturation voltage	Common-emitter V _E =0, I _C =200 mA		1.3	V
		Emitter-follower V _C =15 V, I _E =-200 mA		2.5	
I _{OCH}	Output control input current	V _I =V _{ref}		3.5	mA
Total Device					
I _{CC}	Standby supply current	All other inputs & outputs open	V _{CC} =15 V	10	mA
			V _{CC} =40 V	15	
I _{CCA}	Average supply current	V _(pin 4) =2 V		17	mA

Notes: 1. Duration of the short circuit should not exceed one second.

2. Standard deviation is a measure of the statistical distribution about the mean as derived from the formula

$$\sigma = \sqrt{\frac{\sum_{n=1}^N (x_n - \bar{x})^2}{N - 1}}$$

**N SUFFIX PLASTIC DIP
(MS - 001BB)**

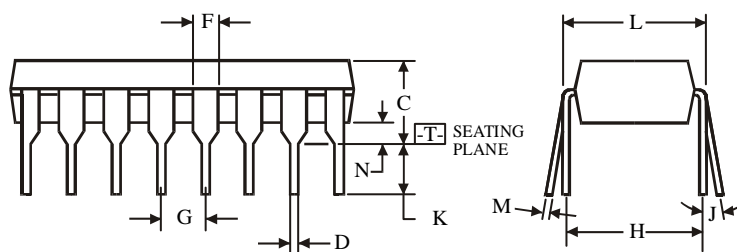
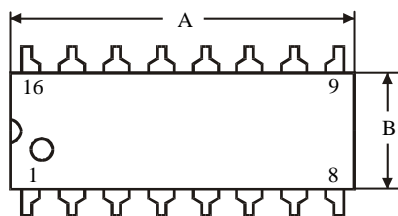
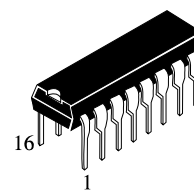

$\oplus 0.25 (0.010) \text{ (M) T}$

NOTES:

- Dimensions "A", "B" do not include mold flash or protrusions.
Maximum mold flash or protrusions 0.25 mm (0.010) per side.

Symbol	Dimension, mm	
	MIN	MAX
A	18.67	19.69
B	6.1	7.11
C		5.33
D	0.36	0.56
F	1.14	1.78
G	2.54	
H	7.62	
J	0°	10°
K	2.92	3.81
L	7.62	8.26
M	0.2	0.36
N	0.38	

**D SUFFIX SOIC
(MS - 012AC)**

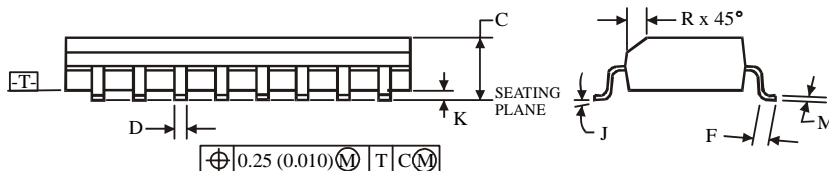
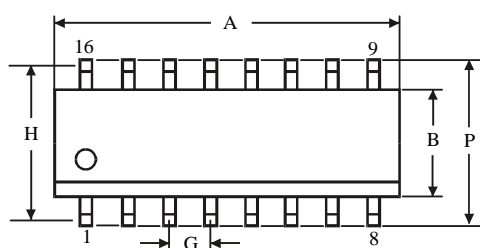
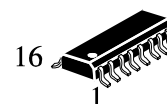

$\oplus 0.25 (0.010) \text{ (M) T C (M)}$

NOTES:

- Dimensions A and B do not include mold flash or protrusion.
- Maximum mold flash or protrusion 0.15 mm (0.006) per side for A; for B - 0.25 mm (0.010) per side.

Symbol	Dimension, mm	
	MIN	MAX
A	9.8	10
B	3.8	4
C	1.35	1.75
D	0.33	0.51
F	0.4	1.27
G	1.27	
H	5.72	
J	0°	8°
K	0.1	0.25
M	0.19	0.25
P	5.8	6.2
R	0.25	0.5