

ROV05, ROV05H

5mm Series Metal Oxide Varistors

www.circuitprotection.com

Document: SCD 25480
Status: Released
Rev. C May 18, 2005

GENERAL DESCRIPTION

The ROV05-XXX (Radial-leaded Metal Oxide Varistor) products are 5mm radial leaded varistor devices suitable for protection of overvoltage transients.

ROV devices can provide protection for a wide variety of power systems against overvoltage faults such as lightning, power contact and power induction. Suitable for a broad range of applications including, but not limited to security, power supplies, surge strips, etc., the ROV device helps to protect valuable equipment from potential power surge damage by clamping high energy, short duration impulses. The ROV devices have high current handling and energy absorption capability and fast response times to help protect against transient faults.

FEATURES

- Radial leaded
- Broad Varistor voltage and V_{rms} range
 - Varistor voltage : 18V - 750V
 - V_{rms} voltage : 11V - 460V
- Two surge capability series
 - Standard series, High surge series
- Various lead types
 - Straight, Kinked, Other
- Various packaging options
 - Bulk, Tape & Reel, Ammo Pack
- Helps designers meet the following standards
 - UL, CSA, VDE
- Fast response time
- High current and energy absorption capability

APPLICATIONS

- Power supplies and power systems
- Line voltage
- Telecommunications systems
- Automotive systems
- Appliances

TYPICAL APPLICATION SCHEMATIC

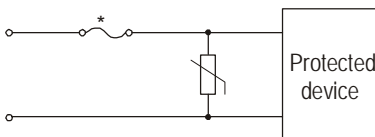

*In some applications, a polymeric PTC device such as a Tyco Electronics PolySwitch device may be used instead of a fuse to provide a preferred solution.

MATERIALS INFORMATION

RoHS Compliant

ELV Compliant

Directive 2002/95/EC
Compliant

Directive 2000/53/EC
Compliant

*After May 1, 2005 all ROV devices will be produced as RoHS compliant devices.

ROV05, ROV05H

5mm Series Metal Oxide Varistors

www.circuitprotection.com

Document: SCD 25480
Status: Released
Rev. C May 18, 2005

PART NUMBERING

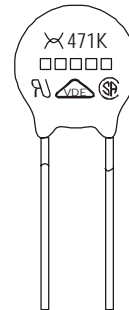
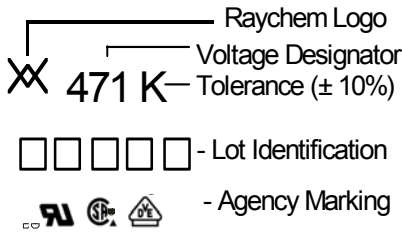
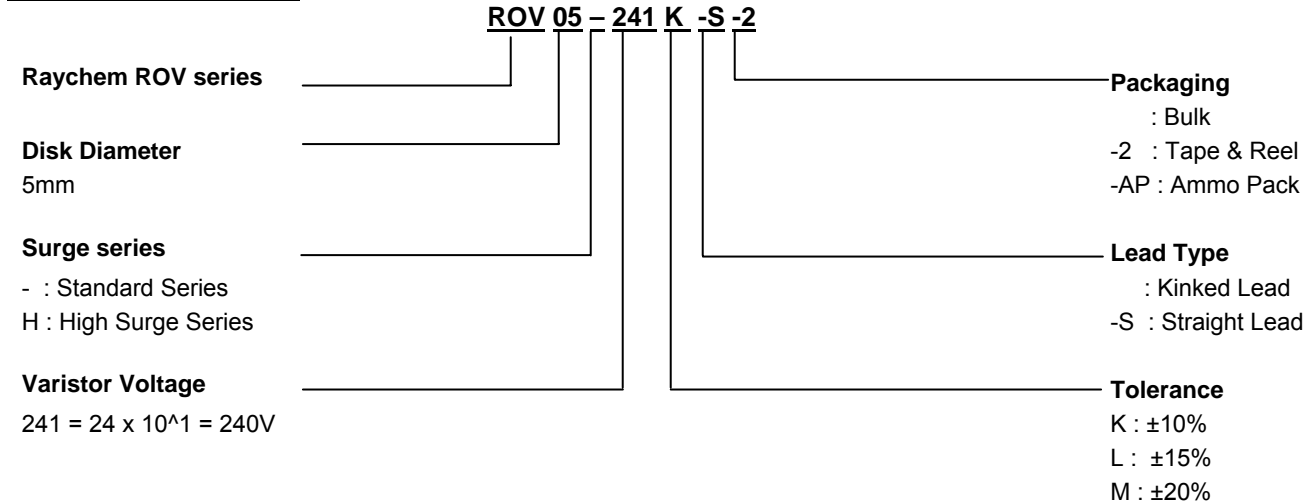

Lot Identification
RoHS compliant devices: 4 characters
Non RoHS compliant devices: 5 characters with M at the end.

GENERAL CHARACTERISTICS

Storage temperature:	-40°C ... +125°C
Maximum operating temperature:	-40°C ... + 85°C
Maximum working surface temperature:	+115°C
Temperature coefficient of voltage:	0 ... +0.05% / °C max.
Insulation resistance of coating (@ 500 VDC):	Over 1000MΩ
Maximum response time:	25ns
Lead Material:	22 AWG Sn Plated Copper

AGENCY RECOGNITION

Device Ratings and Characteristics Tables contain specific recognition information for each individual part. The table below details marking symbols for each agency recognition type.

UL1414	UL1449 (2nd Edition)	CSA	VDE
◆	●	▲	■

ROV05, ROV05H

5mm Series Metal Oxide Varistors

www.circuitprotection.com

Document: SCD 25480
Status: Released
Rev. C May 18, 2005

DEVICE RATINGS AND CHARACTERISTICS

STANDARD SERIES

Part Number	Varistor Voltage V@0.1mA		Maximum Allowable Voltage		Maximum Clamping Voltage V@5A	Maximum Surge Current (8x20us)		Rated Wattage	Energy (10x1000us)	Capacitance (Typical)	Certifications
	(V _{DC})	Tolerance	V _{rms} (V _{AC})	(V _{DC})	(V _{DC})	1 Time (A)	2 Times (A)	(W)	(J)	@1kHz (pF)	
ROV05-180M	18	± 20%	11	14	40 ¹⁾	100	50	0.01	0.6	1121	● ■*
ROV05-220L	22	± 15%	14	18	48 ¹⁾				0.7	1233	● ■*
ROV05-270K	27	± 10%	17	22	60 ¹⁾				0.9	1073	● ■*
ROV05-330K	33		20	26	73 ¹⁾				1.1	834	● ■*
ROV05-390K	39		25	31	86 ¹⁾				1.2	877	● ■*
ROV05-470K	47		30	38	104 ¹⁾				1.5	715	● ■*
ROV05-560K	56		35	45	123 ¹⁾				1.8	643	● ■*
ROV05-680K	68		40	56	150 ¹⁾				2.1	501	● ■*
ROV05-820K	82		50	65	145				2.8	269	● ■
ROV05-101K	100		60	85	175				3.5	263	● ■
ROV05-121K	120		75	100	210				4.0	180	● ■
ROV05-151K	150		95	125	260				5.5	180	● ■
ROV05-181K	180		115	150	320				6.5	95	● ■
ROV05-201K	200		130	170	355				7.1	85	◆ ● ▲ ■
ROV05-221K	220		140	180	380	7.8	80	◆ ● ▲ ■			
ROV05-241K	240		150	200	415	8.4	74	◆ ● ▲ ■			
ROV05-271K	270	175	225	475	9.9	69	◆ ● ▲ ■				
ROV05-301K	300	195	250	525	400	200	0.1	10.5	65	◆ ● ▲ ■	
ROV05-331K	330	210	275	575				11.5	60	◆ ● ▲ ■	
ROV05-361K	360	230	300	620				13.0	69	◆ ● ▲ ■	
ROV05-391K	390	250	320	675				15.0	56	◆ ● ▲ ■	
ROV05-431K	430	275	350	745				16.5	47	◆ ● ▲ ■	
ROV05-471K	470	300	385	810				17.5	50	◆ ● ▲ ■	
ROV05-511K	510	320	418	880				18.5	50	◆ ● ▲ ■*	
ROV05-561K	560	350	460	940				19.5	50	◆ ● ▲ ■*	
ROV05-621K	620	385	505	1050				20.5	50	◆ ● ▲ ■*	
ROV05-681K	680	420	560	1150				21.5	43	◆ ● ▲ ■*	
ROV05-751K	750	460	615	1290				22.5	----	◆ ● ▲ ■*	

* Pending VDE recognition

1) The clamping voltage for devices ROV05-180M to ROV05-680K is tested with 1A current.

ROV05, ROV05H
5mm Series Metal Oxide Varistors

www.circuitprotection.com

Document: SCD 25480
Status: Released
Rev. C May 18, 2005

PULSE LIFETIME RATING CURVES

V-I CHARACTERISTIC CURVES

STANDARD SERIES

STANDARD SERIES

ROV05-180M – ROV05-680K

ROV05-180M – ROV05-680K

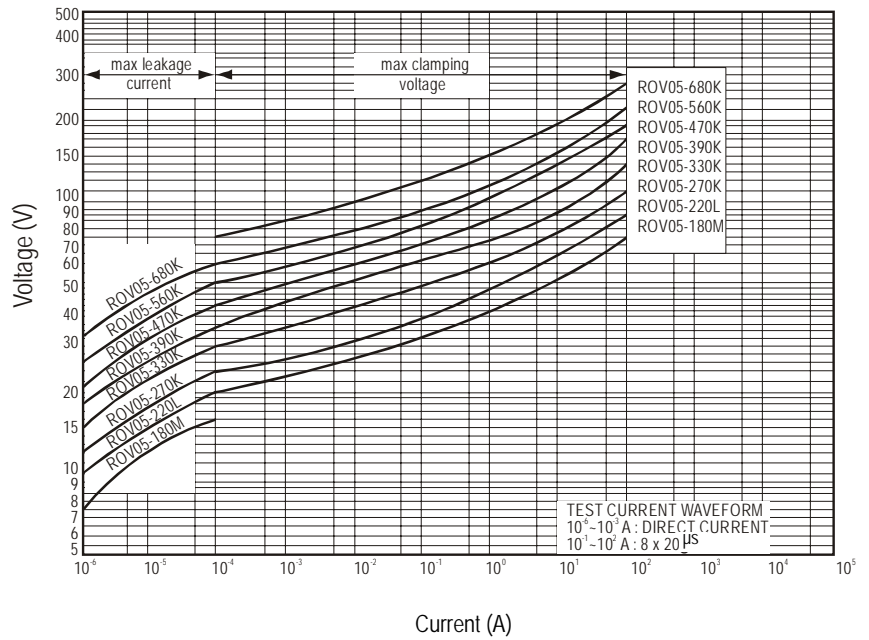
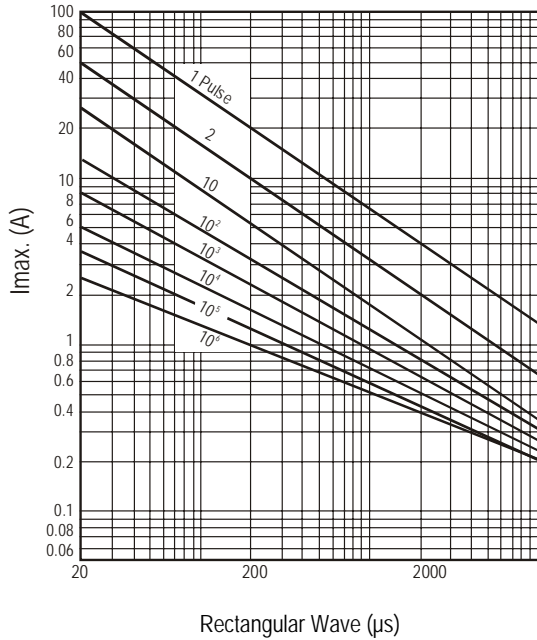

ROV05-820K – ROV05-471K

ROV05-820K – ROV05-471K

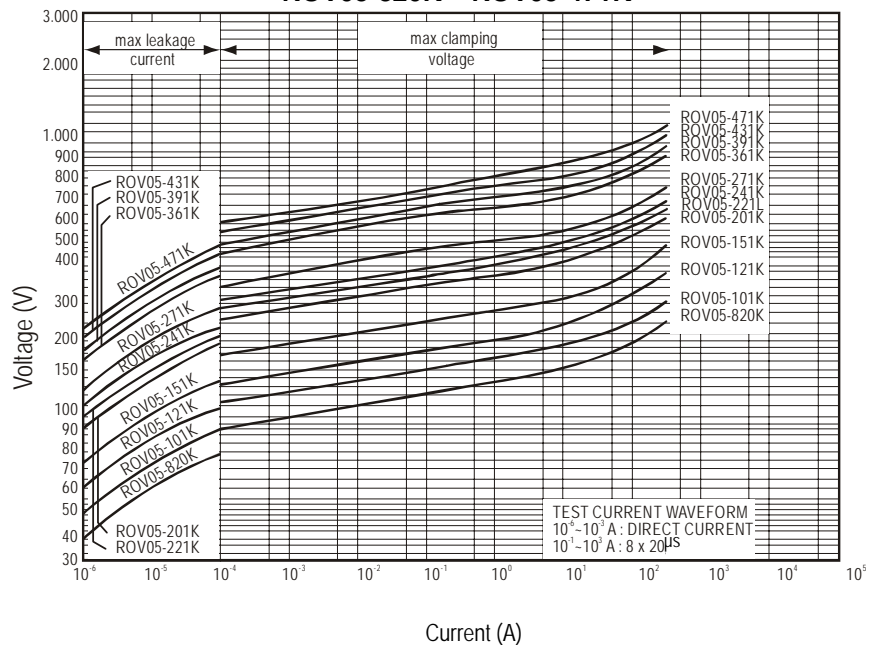
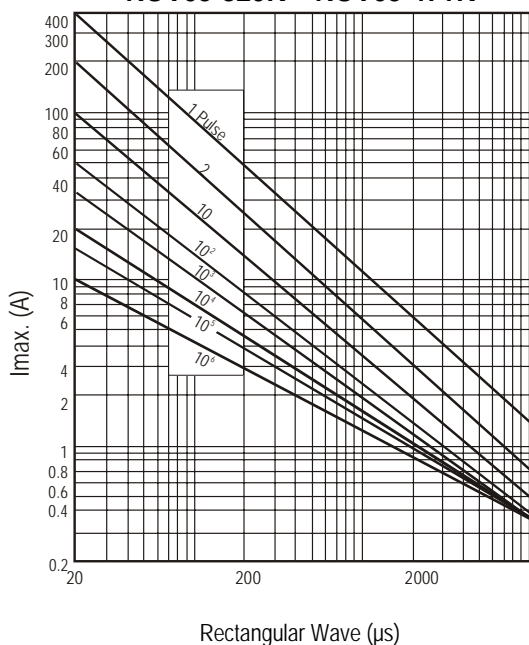

ROV05, ROV05H 5mm Series Metal Oxide Varistors

www.circuitprotection.com

Document: SCD 25480
Status: Released
Rev. C May 18, 2005

DEVICE RATINGS AND CHARACTERISTICS

HIGH SURGE SERIES

Part Number	Varistor Voltage V@0.1mA		Maximum Allowable Voltage		Maximum Clamping Voltage V@5A	Maximum Surge Current (8x20us)		Rated Wattage	Energy (10x1000us)	Capacitance (Typical)	Certifications
	(V _{DC})	Tolerance	V _{rms} (V _{AC})	(V _{DC})	(V _{DC})	1 Time (A)	2 Times (A)	(W)	(J)	@1kHz (pF)	
ROV05H180M	18	± 20%	11	14	40 ¹⁾	250	125	0.01	0.7	1120	● ■*
ROV05H220L	22	± 15%	14	18	48 ¹⁾				0.8	1230	● ■*
ROV05H270K	27	± 10%	17	22	60 ¹⁾				1.1	1070	● ■*
ROV05H330K	33		20	26	73 ¹⁾				1.3	830	● ■*
ROV05H390K	39		25	31	86 ¹⁾				1.5	880	● ■*
ROV05H470K	47		30	38	104 ¹⁾				1.8	720	● ■*
ROV05H560K	56		35	45	123 ¹⁾				2.2	640	● ■*
ROV05H680K	68		40	56	150 ¹⁾				2.6	500	● ■*
ROV05H820K	82		50	65	145	3.5	270	● ■*			
ROV05H101K	100		60	85	175	4.5	260	● ■*			
ROV05H121K	120	75	100	210	5.5	180	● ■*				
ROV05H151K	150	95	125	260	6.5	180	● ■*				
ROV05H181K	180	115	150	320	8.0	95	● ■*				
ROV05H201K	200	130	170	355	8.5	85	◆ ● ▲ ■*				
ROV05H221K	220	140	180	380	9.0	80	◆ ● ▲ ■*				
ROV05H241K	240	150	200	415	10.5	75	◆ ● ▲ ■*				
ROV05H271K	270	175	225	475	11.0	70	◆ ● ▲ ■*				
ROV05H301K	300	195	250	525	800	600	0.10	12.0	65	◆ ● ▲ ■*	
ROV05H331K	330	210	275	575				13.0	60	◆ ● ▲ ■*	
ROV05H361K	360	230	300	620				16.0	70	◆ ● ▲ ■*	
ROV05H391K	390	250	320	675				17.0	55	◆ ● ▲ ■*	
ROV05H431K	430	275	350	745				20.0	45	◆ ● ▲ ■*	
ROV05H471K	470	300	385	810				21.0	50	◆ ● ▲ ■*	
ROV05H511K	510	320	418	880				22.0	50	◆ ● ▲ ■*	
ROV05H561K	560	350	460	940				25.0	50	◆ ● ▲ ■*	
ROV05H621K	620	385	505	1050	27.0	50	◆ ● ▲ ■*				
ROV05H681K	680	420	560	1150	28.0	40	◆ ● ▲ ■*				
ROV05H751K	750	460	615	1290	29.0	----	◆ ● ▲ ■*				

* Pending VDE Recognition

1). The clamping voltage for devices ROV05H180M to ROV05H680K is tested with 1A current.

ROV05, ROV05H
5mm Series Metal Oxide Varistors

www.circuitprotection.com

Document: SCD 25480
Status: Released
Rev. C May 18, 2005

PULSE LIFETIME RATING CURVES

V-I CHARACTERISTIC CURVES

HIGH SURGE SERIES

HIGH SURGE SERIES

ROV05H180M – ROV05H680K

ROV05H180M – ROV05H680K

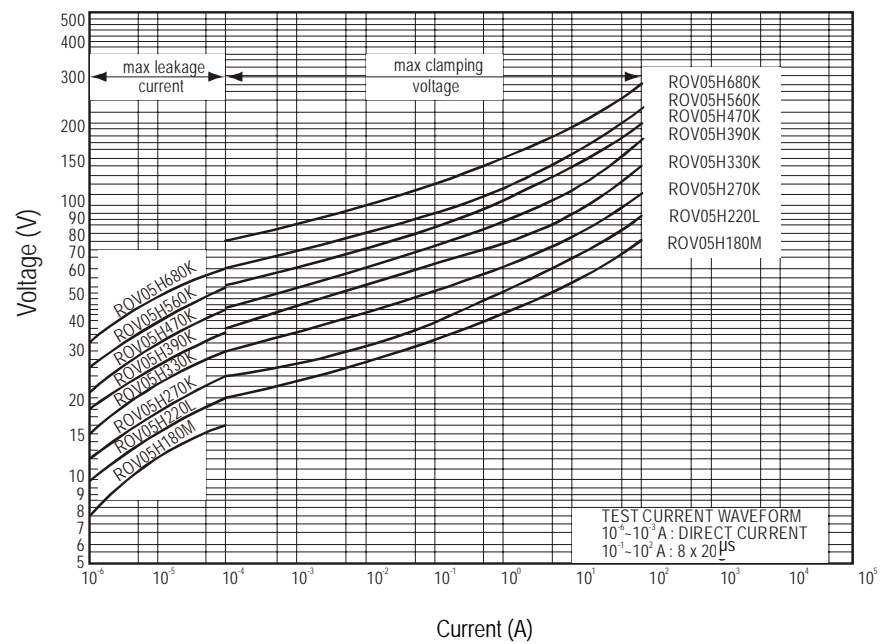
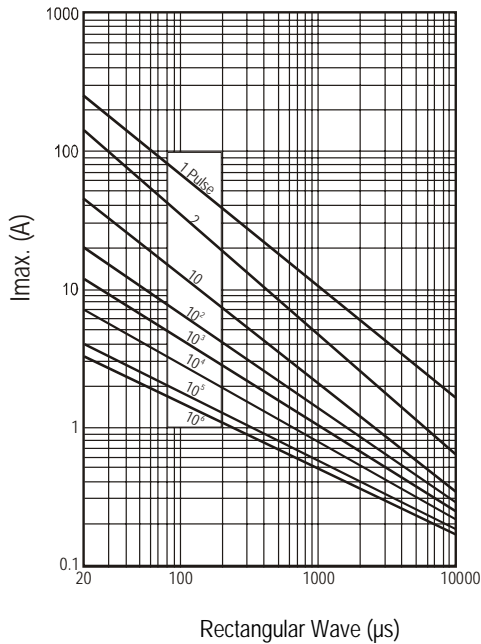

Rectangular Wave (μs)

Current (A)

ROV05H820K – ROV05H471K

ROV05H820K – ROV05H471K

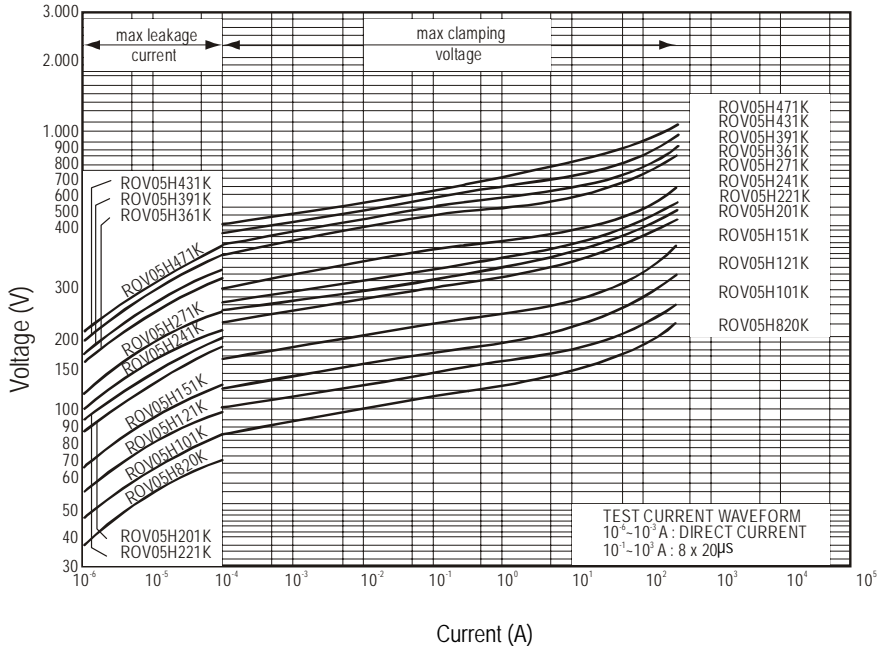
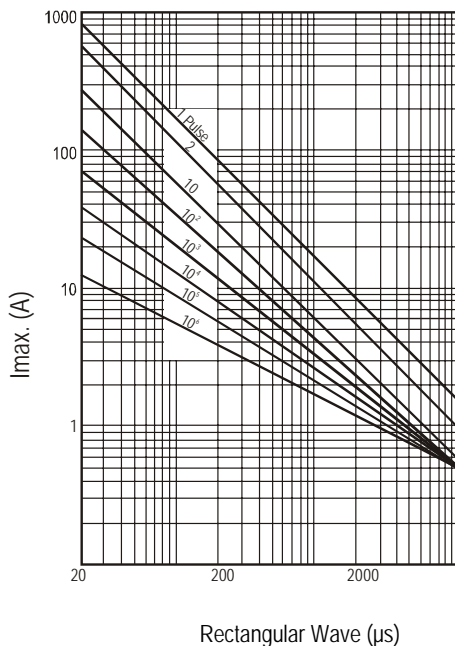

Rectangular Wave (μs)

Current (A)

ROV05, ROV05H
5mm Series Metal Oxide Varistors

www.circuitprotection.com

Document: SCD 25480
Status: Released
Rev. C May 18, 2005

DIMENSIONS

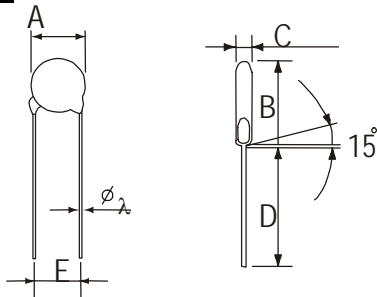

KINKED LEAD TYPE
Dimension Table

A max.	7.5
$\lambda \pm 0.05$	0.6
$E \pm 1.0$	5.0
B max.	11.0
D_1 min.	25.0
D min.	24.0

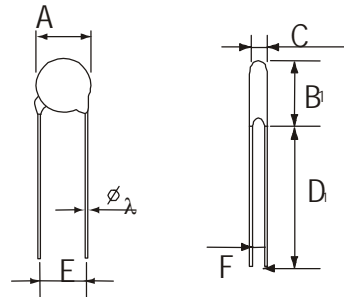

STRAIGHT LEAD TYPE (-S)
Table of C max., F, and B₁ max.

Type No.	C max.	F ± 0.8	B ₁ max.
180M	4.5	0.8	10.5
220L	4.5	0.9	10.5
270K	4.7	0.9	10.5
330K	4.7	1.0	10.5
390K	4.7	1.2	10.5
470K	5.0	1.2	10.5
560K	5.0	1.4	10.5
680K	5.5	1.7	10.5
820K	3.8	0.8	10.5
101K	3.9	0.8	10.5
121K	4.1	0.9	10.5
151K	4.5	1.2	10.5
181K	4.1	1.0	10.5
201K	4.2	1.0	10.5
221K	4.3	1.1	10.5
241K	4.4	1.1	10.5
271K	4.6	1.3	10.5
301K	4.8	1.3	10.5
331K	4.9	1.3	10.5
361K	5.1	1.8	10.5
391K	5.3	2.0	11.0
431K	6.1	2.1	11.0
471K	6.4	2.2	11.0
511K	6.6	2.5	11.5
561K	6.9	2.8	11.5
621K	7.2	3.1	11.5
681K	7.5	3.4	11.5
751K	7.9	3.7	11.5

PACKAGING

ROV05, ROV05H

5mm Series Metal Oxide Varistors

www.circuitprotection.com

Document: SCD 25480
Status: Released
Rev. C May 18, 2005

in mm

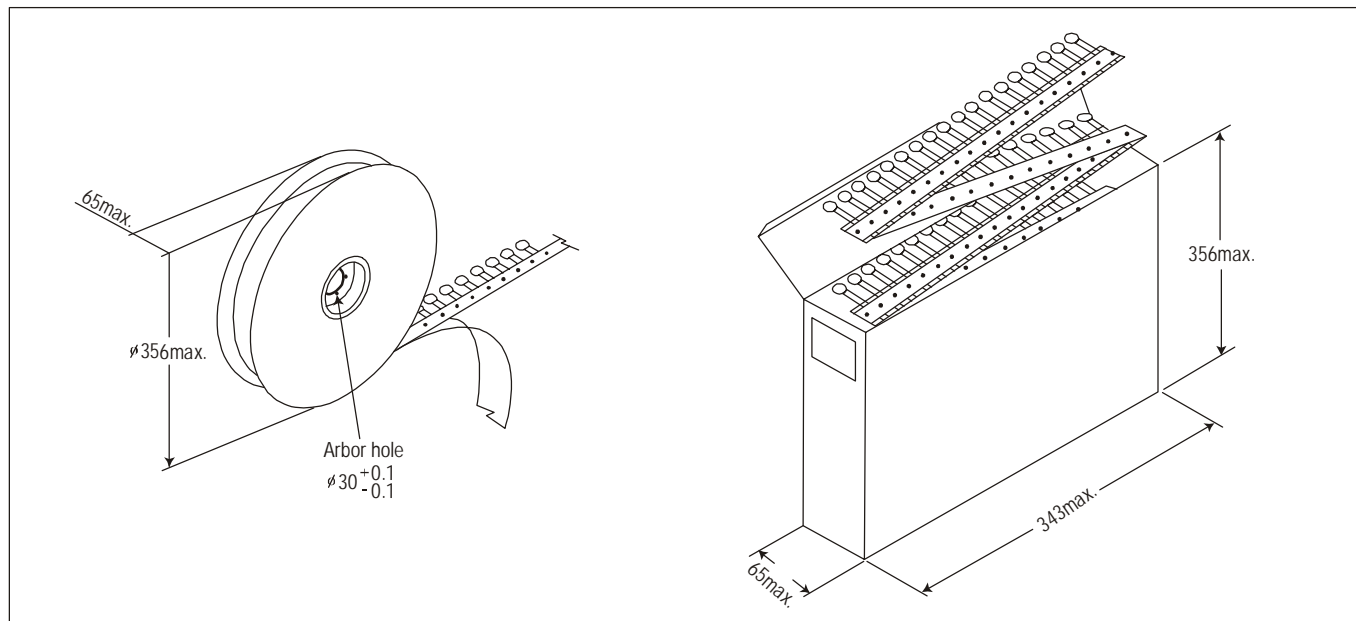

Packaging	Bulk (box)	Reel	Ammo
Box size (mm)	290 x 155 x 110	350 x 350 x 108	330 x 240 x 46
Carton size (mm)	310 x 328 x 250	371 x 371 x 590	350 x 500 x 270
One carton with	4 Boxes	5 Boxes (10 reels)	10 Boxes

Part Number	Bulk (box)	Reel	Ammo
ROV05-180M to ROV05-470K, ROV05H180M to ROV05H470K	5000	1500	1500
ROV05-560K to ROV05-680K, ROV05H560K to ROV05H680K	5000	1500	1000
ROV05-820K to ROV05-331K, ROV05H820K to ROV05H331K	5000	1500	1500
ROV05-361K to ROV05-391K, ROV05H361K to ROV05H391K	5000	1500	1000
ROV05-431K to ROV05-471K, ROV05H431K to ROV05H471K	5000	1500	1000
ROV05-511K to ROV05-751K, ROV05H511K to ROV05H751K	4000	1000	1000

ROV05, ROV05H
5mm Series Metal Oxide Varistors

www.circuitprotection.com

Document: SCD 25480
Status: Released
Rev. C May 18, 2005

TAPE AND REEL DIMENSIONS

1/2" Pitch

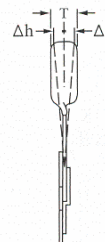
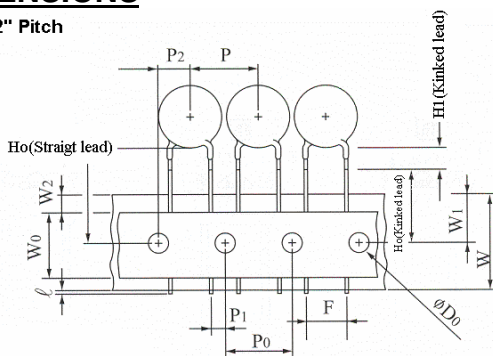

1.0" Pitch

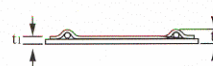
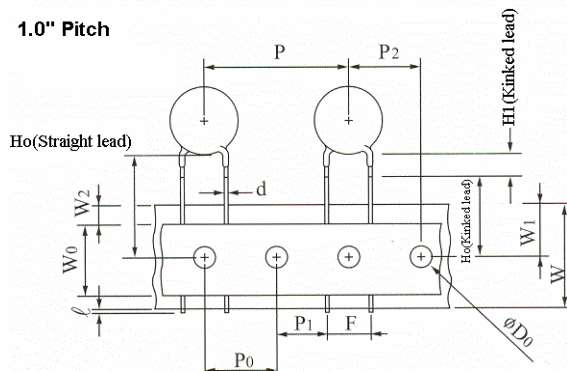

Symbols	Item	Value
λ	Cut out length	1.1mm max.
H_1 (Kinked lead)	Height of kink	3.5mm max.
H_o (Kinked lead)	Height to seating plane	16.0 ± 0.5mm
H_o (Straight lead)	Height of component from hole center	16.0-21.0mm
Δh	Front to back deviation	0.0 ± 2.0mm
W	Carrier tape width	18.0 $\begin{smallmatrix} +1.0 \\ -0.5 \end{smallmatrix}$ mm
W_0	Hold down tape width	10.0mm
W_1	Sprocket hole position	9.0 $\begin{smallmatrix} +0.75 \\ -0.5 \end{smallmatrix}$ mm
W_2	Adhesive tape position	3.0mm max.
F	Component lead spacing	5.0 $\begin{smallmatrix} +0.8 \\ -0.2 \end{smallmatrix}$ mm
P	Pitch of component	12.7 ± 1.0mm
P_0	Sprocket hole pitch	12.7 ± 0.3mm
P_1	Lead length from hole center to lead	3.85 ± 0.7mm
P_2	Length from hole center to disk center	6.35 ± 1.3mm
D_0	Sprocket hole diameter	4.0 ± 0.2mm
d	Lead wire diameter	0.6 ± 0.05mm
T	Disk thickness	See C. max table
t_1	Total thickness tape	0.7 ± 0.05mm
t_2	Total thickness	1.6mm max.

ROV05, ROV05H

5mm Series Metal Oxide Varistors

www.circuitprotection.com

Document: SCD 25480
Status: Released
Rev. C May 18, 2005

Information furnished is believed to be accurate and reliable. However, users should independently evaluate the suitability of each product for their applications. Tyco Electronics Corporation assumes no responsibility for the use of its product or for any infringement of patents or other rights of third parties resulting from the use of its product. No license is granted by implication or otherwise under any patent or proprietary right of Tyco Electronics except the right to use such product for the purpose for which it is sold. Tyco Electronics reserves the right to change or update, without notice, any information contained in this publication; to change, without notice, the design, construction, processing, or specification of any product; and to discontinue or limit production or distribution of any product. This publication supersedes and replaces all information previously supplied. Without express written consent by an officer of Tyco Electronics, Tyco Electronics does not authorize the use of any its products as components in nuclear facility applications, aerospace, or in critical life support devices or systems. Tyco Electronics' only obligations are those in the Tyco Electronics Standard Terms and Conditions of Sale and in no case will Tyco Electronics be liable for any incidental, indirect, or consequential damages arising from the sale, resale, use, or misuse of its products.

Raychem is a trademark of Tyco Electronics Corporation