

Video/Audio Interfaces for TV and DVD Recorders

# NTSC-PAL Video

# I/O Interface

## BH7625KS2



### ●Description

BH7625KS2 is a video signal selector with two built-in sync separation circuits, and two sync detector circuits. It includes 5-composit, 5-Y, 5-C, and 1-component video signal inputs that can be selected freely for each output. Additionally, The existence of the signal outputted from outside can be judged by only this chip.

### ●Features

- 1) Built-in 5-video, 5-Y, 5-C and 1-component inputs
- 2) Input terminal of the S2 standard suitability
- 3) I<sup>2</sup>C-BUS control (High impedance when power supply off)
- 4) Built-in 0/3dB switch AMP (CVBS OUT, C OUT)
- 5) Built-in 0/6dB switch AMP (Y/CVBS OUT)
- 6) Built-in sync separation circuit (2 circuits SYNC OUT, V SYNC OUT)
- 7) Built-in sync detector circuit (2 circuits)
- 8) Built-in 3 LPF circuits (4 order + TRAP)

### ●Applications

DVD-Recorder, visual instrument, etc

### ●Absolute maximum ratings (Ta=25°C)

Parameter	Symbol	Limits	Unit
Power Supply Voltage	V	7.0	V
Power dissipation	Pd	1300 *1	mW
Operating temperature range	Topr	-25~+75	°C
Storage temperature range	Tstg	-55~+125	°C

\*1 Reduced by 13 mW/°C at 25°C or higher.

### ●Operating range (Ta=25°C)

Parameter	Symbol	Limits	Unit
Supply voltage	VCC1	4.5~5.5	V
	VCC2		
	VCC3		
	DVCC		
	SYNC VCC		
	VCC		

● **Electrical characteristics** (Unless otherwise specified, Vcc1, Vcc2, Vcc3, DVCC, SYNC VCC, VCC=5V, Ta=25°C)

Item	Symbol	Limit			Unit	Conditions	
		MIN.	TYP.	MAX.			
< Whole >							
VCC Circuit Current	I <sub>CC</sub>	71	95	128	mA	Normal Condition	
VCC STBY Circuit Current	I <sub>CCST</sub>	9.38	12.5	16.9	mA	Standby Condition	
VCC PD Circuit Current	I <sub>CCPD</sub>	—	0	10	μA	Power Down Condition	
< SW Part >							
CVBS OUT Cb OUT	Voltage Gain H	G <sub>V1H</sub>	2.4	2.9	3.4	dB	Vin=1.0Vpp, f=100kHz, LPF OFF
CVBS OUT Cb OUT	Voltage Gain L	G <sub>V1L</sub>	-0.7	-0.2	0.3	dB	Vin=1.0Vpp, f=100kHz, LPF OFF
Y/CVBS OUT Cy OUT	Voltage Gain H	G <sub>V2H</sub>	5.5	6.0	6.5	dB	Vin=1.0Vpp, f=100kHz, LPF OFF
Y/CVBS OUT Cy OUT	Voltage Gain L	G <sub>V2L</sub>	-0.7	-0.2	0.3	dB	Vin=1.0Vpp, f=100kHz, LPF OFF
C OUT Cr OUT	Voltage Gain H	G <sub>V3H</sub>	2.4	2.9	3.4	dB	Vin=1.0Vpp, f=100kHz, LPF OFF
C OUT Cr OUT	Voltage Gain L	G <sub>V3L</sub>	-0.7	-0.2	0.3	dB	Vin=1.0Vpp, f=100kHz, LPF OFF
CVBS OUT Cb OUT	Voltage Gain H	G <sub>V4H</sub>	2.2	2.7	3.2	dB	Vin=1.0Vpp, f=100kHz, LPF ON
CVBS OUT Cb OUT	Voltage Gain L	G <sub>V4L</sub>	-0.9	-0.4	0.1	dB	Vin=1.0Vpp, f=100kHz, LPF ON
Y/CVBS OUT Cy OUT	Voltage Gain H	G <sub>V5H</sub>	5.3	5.8	6.3	dB	Vin=1.0Vpp, f=100kHz, LPF ON
Y/CVBS OUT Cy OUT	Voltage Gain L	G <sub>V5L</sub>	-0.9	-0.4	0.1	dB	Vin=1.0Vpp, f=100kHz, LPF ON
C OUT Cr OUT	Voltage Gain H	G <sub>V6H</sub>	2.2	2.7	3.2	dB	Vin=1.0Vpp, f=100kHz, LPF ON
C OUT Cr OUT	Voltage Gain L	G <sub>V6L</sub>	-0.9	-0.4	0.1	dB	Vin=1.0Vpp, f=100kHz, LPF ON
CVBS OUT Cb OUT	Maximum Output Level	V <sub>OM1</sub>	2.6	3.0	—	Vpp	f=100kHz(10kHz), THD=1%
Y/CVBS OUT Cy OUT	Maximum Output Level	V <sub>OM2</sub>	2.6	3.0	—	Vpp	f=100kHz(10kHz), THD=1%
C OUT Cr OUT	Maximum Output Level	V <sub>OM3</sub>	2.6	3.0	—	Vpp	f=100kHz(10kHz), THD=1%
< SW Part >							
CVBS OUT Cb OUT	Frequency Characteristic 1	G <sub>F11</sub>	-1.5	-0.5	0.5	dB	Vin=1.0Vpp Gain=3dB Vin=2.0Vpp Gain=0dB f=6.75MHz/100kHz(LPF ON)
CVBS OUT Cb OUT	Frequency Characteristic 2	G <sub>F12</sub>	—	-38	-27	dB	Vin=1.0Vpp Gain=3dB Vin=2.0Vpp Gain=0dB f=27MHz/100kHz (LPF ON)

Item		Symbol	Limit			Unit	Conditions
			MIN.	TYP.	MAX.		
CVBS OUT Cb OUT	Frequency Characteristic 3	$G_{F13}$	-1.0	0	1.0	dB	$V_{in}=1.0V_{pp}$ Gain=3dB $V_{in}=2.0V_{pp}$ Gain=0dB f=7MHz/100kHz (Through)
Y/CVBS OUT Cy OUT	Frequency Characteristic 1	$G_{F21}$	-1.5	-0.5	0.5	dB	$V_{in}=1.0V_{pp}$ Gain=6dB $V_{in}=2.0V_{pp}$ Gain=0dB f=6.75MHz/100kHz (LPF ON)
Y/CVBS OUT Cy OUT	Frequency Characteristic 2	$G_{F22}$	-	-38	-27	dB	$V_{in}=1.0V_{pp}$ Gain=6dB $V_{in}=2.0V_{pp}$ Gain=0dB f=27MHz/100kHz (LPF ON)
Y/CVBS OUT Cy OUT	Frequency Characteristic 3	$G_{F23}$	-1.0	0	1.0	dB	$V_{in}=1.0V_{pp}$ Gain=6dB $V_{in}=2.0V_{pp}$ Gain=0dB f=7MHz/100kHz (Through)
C OUT Cr OUT	Frequency Characteristic 1	$G_{F31}$	-1.5	-0.5	0.5	dB	$V_{in}=1.0V_{pp}$ Gain=3dB $V_{in}=2.0V_{pp}$ Gain=0dB f=6.75MHz/100kHz (LPF ON)
C OUT Cr OUT	Frequency Characteristic 3	$G_{F33}$	-1.0	0	1.0	dB	$V_{in}=1.0V_{pp}$ Gain=3dB $V_{in}=2.0V_{pp}$ Gain=0dB f=7MHz/100kHz (Through)
V-SW	Difference In Switch Voltage Gain	$\Delta G_V$	-0.5	0.0	0.5	dB	f=100kHz, $V_{in}=1.0V_{pp}$
Y-SW	Difference In Switch Voltage Gain	$\Delta G_Y$	-0.5	0.0	0.5	dB	f=100kHz, $V_{in}=1.0V_{pp}$
C-SW	Difference In Switch Voltage Gain	$\Delta G_C$	-0.5	0.0	0.5	dB	f=100kHz, $V_{in}=1.0V_{pp}$
V-SW	Switch Crosstalk	$C_{TSV}$	-	-60	-55	dB	f=4.43MHz, $V_{in}=1.0V_{pp}$
Y-SW	Switch Crosstalk	$C_{TSY}$	-	-60	-55	dB	f=4.43MHz, $V_{in}=1.0V_{pp}$
C-SW	Switch Crosstalk	$C_{TSC}$	-	-60	-55	dB	f=4.43MHz, $V_{in}=1.0V_{pp}$
V $\leftrightarrow$ Y $\leftrightarrow$ C Channel Crosstalk		$C_{TCH}$	-	-60	-55	dB	f=4.43MHz, $V_{in}=1.0V_{pp}$
C IN Input Impedance		$Z_{CIN}$	12.5	18.0	23.5	k $\Omega$	
< SYNC DETECTOR Part >							
Minimum sync separation level		$SL_{MIN}$	-	0.08	0.15	Vpp	LPF Condition "111"
V SYNC OUT Output Voltage H		$V_{VSH}$	$V_{CC}$ -0.5	$V_{CC}$ -0.1	$V_{CC}$	V	No Load
V SYNC OUT Output Voltage L		$V_{VSL}$	-	0.1	0.5	V	No Load
VD Pulse Width		$T_{WV1}$	-	185	-	$\mu$ sec	$V_{in}=1.0V_{pp}$ , Standard staircase signal LPF Condition "111"
HD Pulse Width		$T_{WH1}$	-	4.5	-	$\mu$ sec	$V_{in}=1.0V_{pp}$ , Standard staircase signal LPF Condition "111"
C SYNC OUT Output Voltage H		$V_{VCH}$	$V_{CC}$ -0.5	$V_{CC}$ -0.1	$V_{CC}$	V	No Load
C SYNC OUT Output Voltage L		$V_{VCL}$	-	0.1	0.5	V	No Load

Item	Symbol	Limit			Unit	Conditions
		MIN.	TYP.	MAX.		
SYNC DET OUT Output Voltage H	V <sub>SDH</sub>	V <sub>CC</sub> -0.5	V <sub>CC</sub> -0.1	V <sub>CC</sub>	V	No Load
SYNC DET OUT Output Voltage L	V <sub>SDL</sub>	—	0.1	0.5	V	No Load
< I <sup>2</sup> C-BUS Control >						
S1/S2 DET Detection Level H	DL <sub>H</sub>	3.4	—	V <sub>CC</sub>	V	16:9 Squeeze Signal
S1/S2 DET Detection Level M	DL <sub>M</sub>	1.3	1.9	2.5	V	4:3 Letter Box Signal
S1/S2 DET Detection Level L	DL <sub>L</sub>	0.0	—	0.7	V	4:3 Video Signal, No Signal
< ADR >						
Input Voltage H	V <sub>IHDR</sub>	2.0	—	V <sub>CC</sub>	V	
Input Voltage L	V <sub>ILADR</sub>	0.0	—	1.0	V	
Input Impedance	Z <sub>INADR</sub>	65	100	135	kΩ	Pull Down Resistance
< SCL, SDA >						
Input Voltage H	V <sub>IHIC</sub>	2.0	—	V <sub>CC</sub>	V	
Input Voltage L	V <sub>ILIC</sub>	0.0	—	1.0	V	
Input Bias Current	I <sub>BIIC</sub>	0	-1	-10	μA	
< PD >						
Input Voltage H	V <sub>IHPD</sub>	2.0	—	V <sub>CC</sub>	V	
Input Voltage L	V <sub>ILPD</sub>	0.0	—	0.7	V	
Input Impedance	Z <sub>INPD</sub>	65	100	135	kΩ	Pull Down Resistance
< Guaranteed design parameter >						
Differential Gain	D <sub>G</sub>	—	0.5	—	%	CVBS OUT, Y/CVBS OUT, C OUT
Differential Phase	D <sub>P</sub>	—	0.5	—	deg	CVBS OUT, Y/CVBS OUT, C OUT
Y S/N	S <sub>NY</sub>	—	-70	—	dB	CVBS OUT, Y/CVBS OUT 50% White signal Filter : 100kHz~6MHz
C S/N	S <sub>NC</sub>	—	-70	—	dB	C OUT 100% Chroma signal Filter : 100Hz~500kHz

● Block diagram

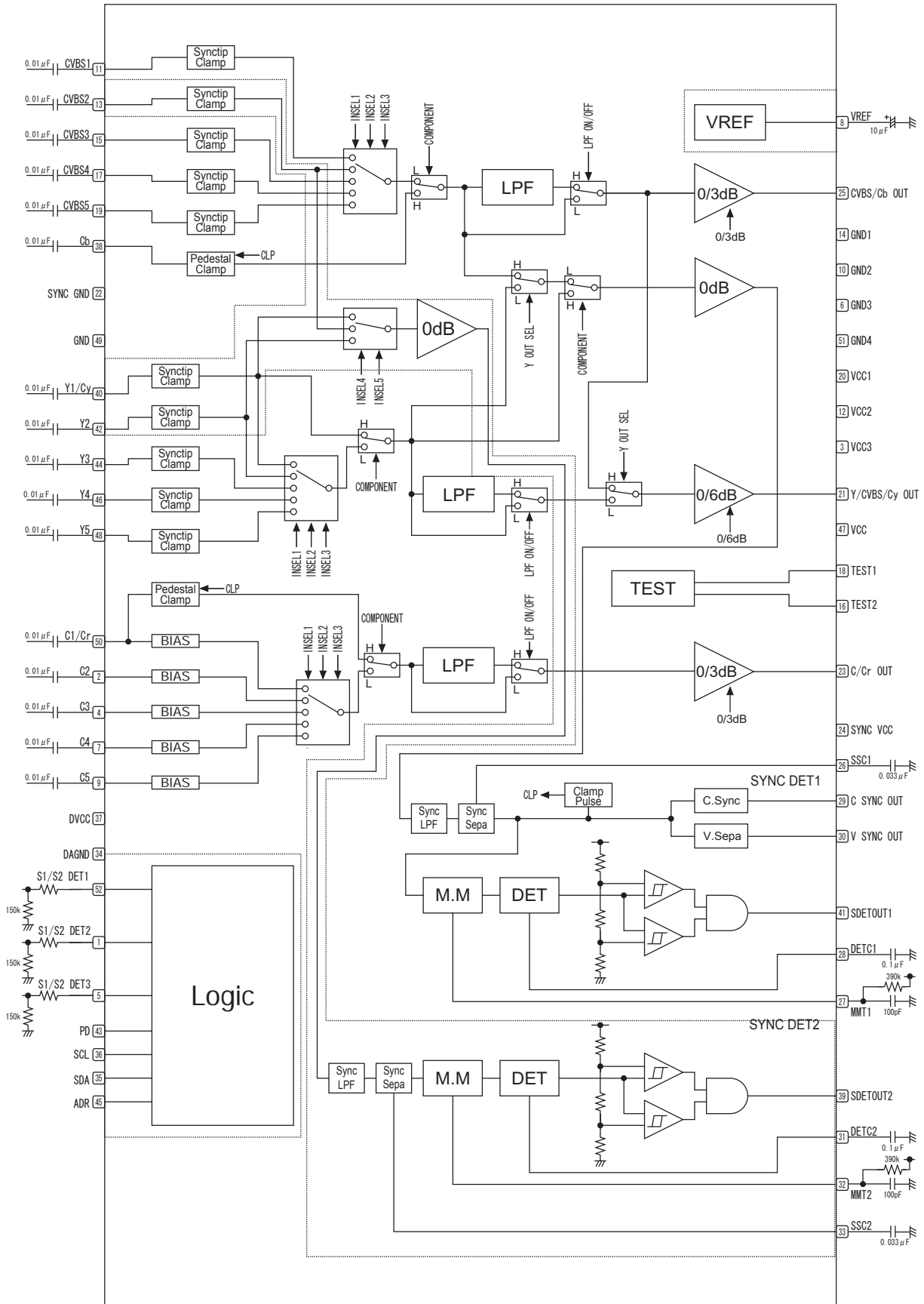

Blocks inside the dotted line operate at a standby mode

Fig.1

●Equivalent circuit

Pin NO./Pin Name (Input/Output)	Function	Equivalent Circuit	Input Range(V)
			Terminal Voltage (V)
14. GND1 10. GND2 6. GND3 51. GND4	GND terminal		0
11. CVBS1 13. CVBS2 15. CVBS3 17. CVBS4 19. CVBS5 40. Y1_Cy 42. Y2 44. Y3 46. Y4 48. Y5	Signal input terminal  The video signal input pins is a sync-tip-clip.		1.4
2. C2 4. C3 7. C4 9. C5	Signal input terminal  The video signal input pins is a resistance bias.		2.9
50. C1_Cr	Signal input terminal  This pin is input of chroma signal1 (C1) and Cr. Change resistor bias and pedestal clamp.		2.9
25. CVBS/Cb OUT 21. Y/CVBS/Cy OUT 23. C/Cr OUT	Signal output terminal  The gain can be selected by I <sup>2</sup> C-BUS.		0.7 2.1
38. Cb	Signal input terminal  The video signal input pin (Cb) is a pedestal clamp.		—
52. S1/S2 DET1 1. S1/S2 DET2 5. S1/S2 DET3	Signal input terminal  The state of inputted signal can be read by I <sup>2</sup> C-BUS.		—
43. PD	PD terminal  Sets power down mode.		0
18. TEST1 16. TEST2	TEST terminal  Shorts to GND.		0

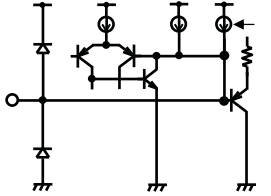
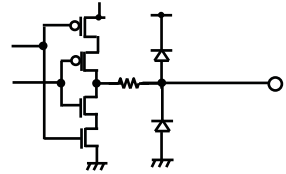
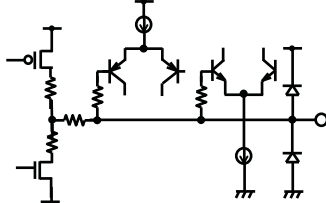
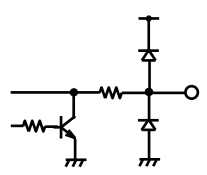
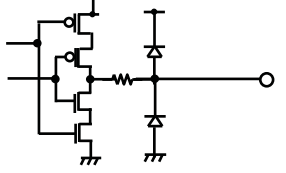
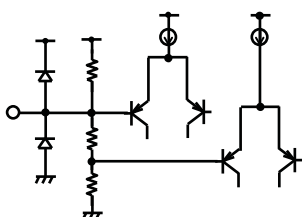
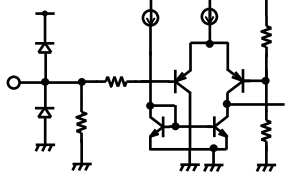
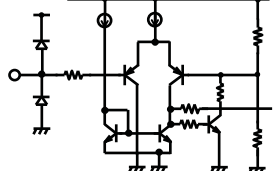
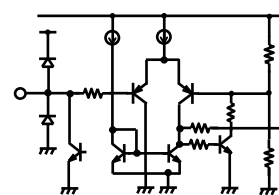
<p>26. SSC1 33. SSC2</p>	<p>SSC terminal</p> <p>Makes reference voltage for sync separation.</p>		<p>—</p>
<p>29. C SYNC OUT 30. V SYNC OUT</p>	<p>C, V sync signal output terminal</p> <p>Outputs sync separation signal.</p>		<p>5.0</p>
<p>28. DETC1 31. DETC2</p>	<p>Generate DET voltage terminal</p> <p>Turns the MM duty pulse into the DC voltage.</p>		<p>—</p>
<p>27. MMT1 32. MMT2</p>	<p>MM adjusting terminal</p> <p>Determines the MM time constant by the outside capacitor and resistor.</p>		<p>—</p>
<p>41. SDET OUT1 39. SDET OUT2</p>	<p>Signal output terminal</p> <p>These pins output sync detecting signal.</p>		<p>0</p>
<p>8. VREF</p>	<p>Reference voltage terminal</p> <p>A capacitor is connected to opposite GND.</p>		<p>2.8</p>
<p>25. ADR</p>	<p>ADR terminal</p> <p>The pin to set slave address 90H (91H) or 92H (93H).</p>		<p>0</p>
<p>36. SCL</p>	<p>I<sup>2</sup>C-BUS Clock input terminal</p> <p>The pin is input clock of I<sup>2</sup>C-BUS. Uses pull up resistor.</p>		<p>—</p>
<p>35. SDA</p>	<p>I<sup>2</sup>C-BUS Data terminal</p> <p>The pin is data of I<sup>2</sup>C-BUS. Uses pull up resistor.</p>		<p>—</p>

●Description of operations

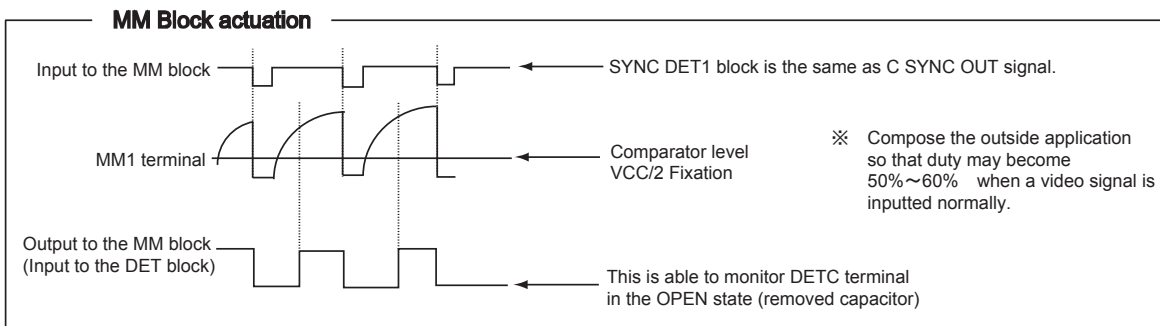
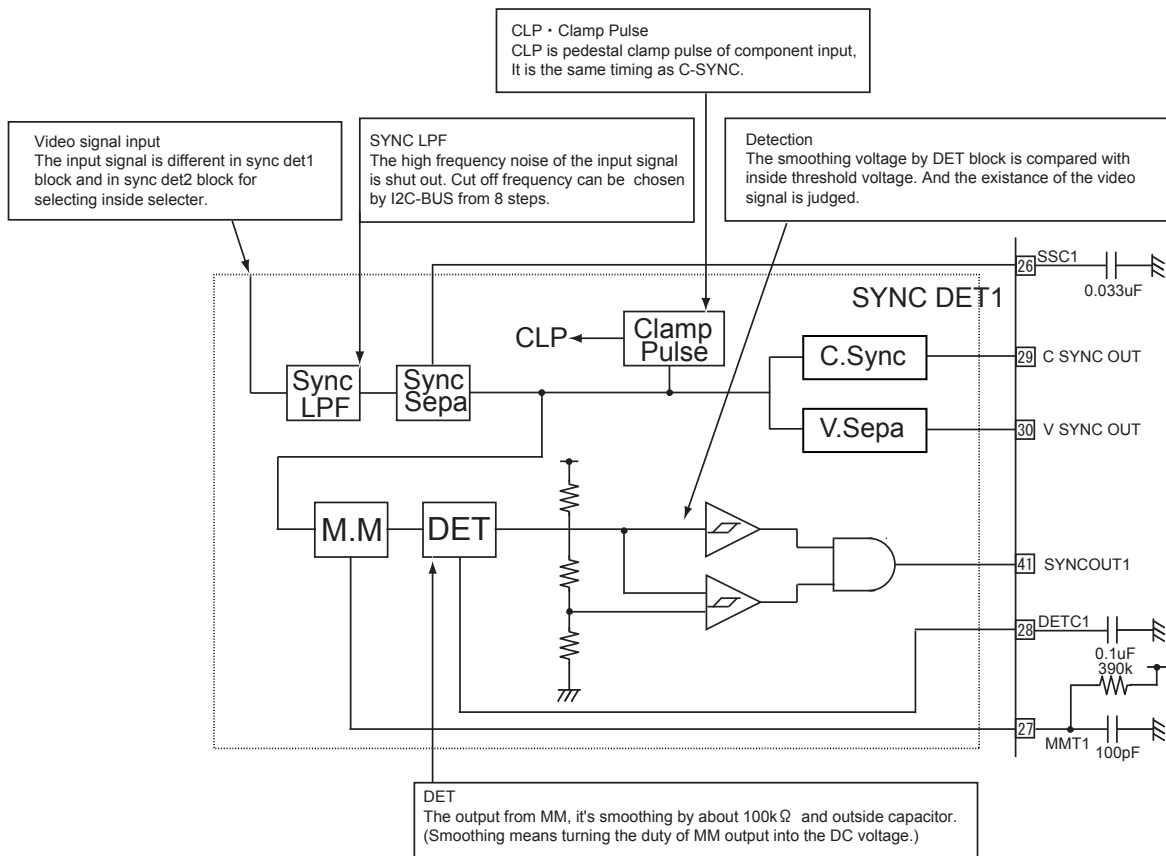

Fig.2

※ The detection sensitivity level of this LSI can be different depending on the tuner used. Therefore, change the detection level setting by selecting LPF cut off and the outside part value of MMT (27 pin, 32 pin) for each tuner when using this feature.



●Description of operations

■I<sup>2</sup>C-BUS Control input specifications

• I<sup>2</sup>C-BUS Format (WRITE MODE)

S	SLAVE ADDRESS	A	DATA1	A	DATA2	A	P
---	---------------	---	-------	---	-------	---	---

S : Start Condition A : Acknowledge P: Stop Condition

	b7	b6	b5	b4	b3	b2	b1	B0
Slave address	1	0	0	1	0	0	ADR	R/W
DATA1	5	4	3	2	1	L2	L1	L0
	INSEL							
DATA2	Y-OUT SEL	Component	LPF ON/OFF	GAIN 0/6dB	STBY	T2	T1	T0

# (Don't Care)

- \* At power on, BH7625KS2 becomes “\*” condition.
- \* ADR and S1/S2 DET terminal inputs value's must be set between start and stop condition and must be consistent, as a change in value may result in poor operation.

○ SELECT INPUT SWITCH • SETTING MODE

	Explanation		Explanation
ADR	Slave Address (write mode) set by ADR pin 0 : Address is “90H”, when ADR pin input is set to L 1 : Address is “92H”, when ADR pin input is set to H	INSEL5~4	SYNC DET2 input setting 00 : Y1/Cy * 01 : Y1/Cy 10 : CVBS2 11 : Y2
R/W	READ/WRITE Setting Mode 0 : WRITE 1 : READ	INSEL3~1	Change setting of input selector SW. Refer to the next page SW correspondence table.
Y-OUT SEL	Y-OUT SEL SW output setting 0 : L * 1 : H	Component	Component SEL SW output setting 0 : L (Composit) * 1 : H (Component)
LPF ON/OFF	LPF ON/OFF setting 0 : L (OFF) * 1 : H (ON)	GAIN0/6dB	AMP GAIN setting 0 : L (0dB) * 1 : H (6dB or 3dB)
Stand-By	Stand-By Mode setting 0 : L (move) 1 : H(standby) ※In standby condition, activate only the circuits in the block diagram.		

○ INPUT SW CONTROL table

INSEL 3	INSEL 2	INSEL 1	Y-OUT SEL	Component	CVBS OUT	Y OUT	C OUT	CSYNC etc.
0	0	0	1	0	CVBS1	CVBS1	C1	CVBS1
0	0	1	1	0	CVBS2	CVBS2	C2	CVBS2
0	1	0	1	0	CVBS3	CVBS3	C3	CVBS3
0	1	1	1	0	CVBS4	CVBS4	C4	CVBS4
1	0	0	1	0	CVBS5	CVBS5	C5	CVBS5
0	0	0	0	0	CVBS1	Y1	C1	Y1
0	0	1	0	0	CVBS2	Y2	C2	Y2
0	1	0	0	0	CVBS3	Y3	C3	Y3
0	1	1	0	0	CVBS4	Y4	C4	Y4
1	0	0	0	0	CVBS5	Y5	C5	Y5
-	-	-	0	1	Cb	Y1(Cy)	C1(Cr)	Y1(Cy)
-	-	-	1	1	Cb	Cb	C1(Cr)	Y1(Cy)

	Explanation		Explanation
L2-L0	SYNC SEPA LPF Cut-off conditioning 000 : LOW (Normal) 001 : ↓ 010 : ↓ 011 : ↓ 100 : ↓ 101 : ↓ 110 : ↓ 111 : High *	T2-T0	DET Output decision comparator threshold conditioning. 000 : LOW (Normal) 001 : ↓ 010 : ↓ 011 : ↓ * 100 : ↓ 101 : ↓ 110 : ↓ 111 : High

○ I<sup>2</sup>C-BUS Format (READ MODE)

S	SLAVE ADDRESS	A	DATA1	A/N	P			
S : Start Condition A : Acknowledge A/N : NO acknowledge P: Stop Condition								
Slave address	B7	b6	b5	b4	b3	b2	b1	b0
	1	0	0	1	0	0	ADR	R/W
DATA1	SD1		SD2		SD3		V-DET2	V-DET1

# (Don't Care)

\* ADR and S1/S2 DET terminal inputs value's must be set between start and stop condition and must be consistent, as a change in value may result in poor operation.

	Explanation		Explanation
ADR	Slave Address (read mode) Set by ADR pin. 0 : Address is "91H", when ADR pin input is set to L 1 : Address is "93H", when ADR pin input is set to H	SD1 SD2 SD3	The state of S1/S2 DET1~S1/S2 DET3 is read out. 00 : 4:3Video signal (0~0.7V) 01 : 4:3Letter Box signal (1.3~2.5V) 11 : 16:9Squeeze signal (3.4V~Vcc)
V-DET1, V-DET2	The signal SDET OUT is read out. 0 : H (VIDEO signal ON) 1 : L (VIDEO signal OFF)		

■ Power down state

Power down state occurs when PD terminal is LOW. Internal circuit becomes non-active in this state.

LOW : Power down state  
 HI : Active state

● Application circuit

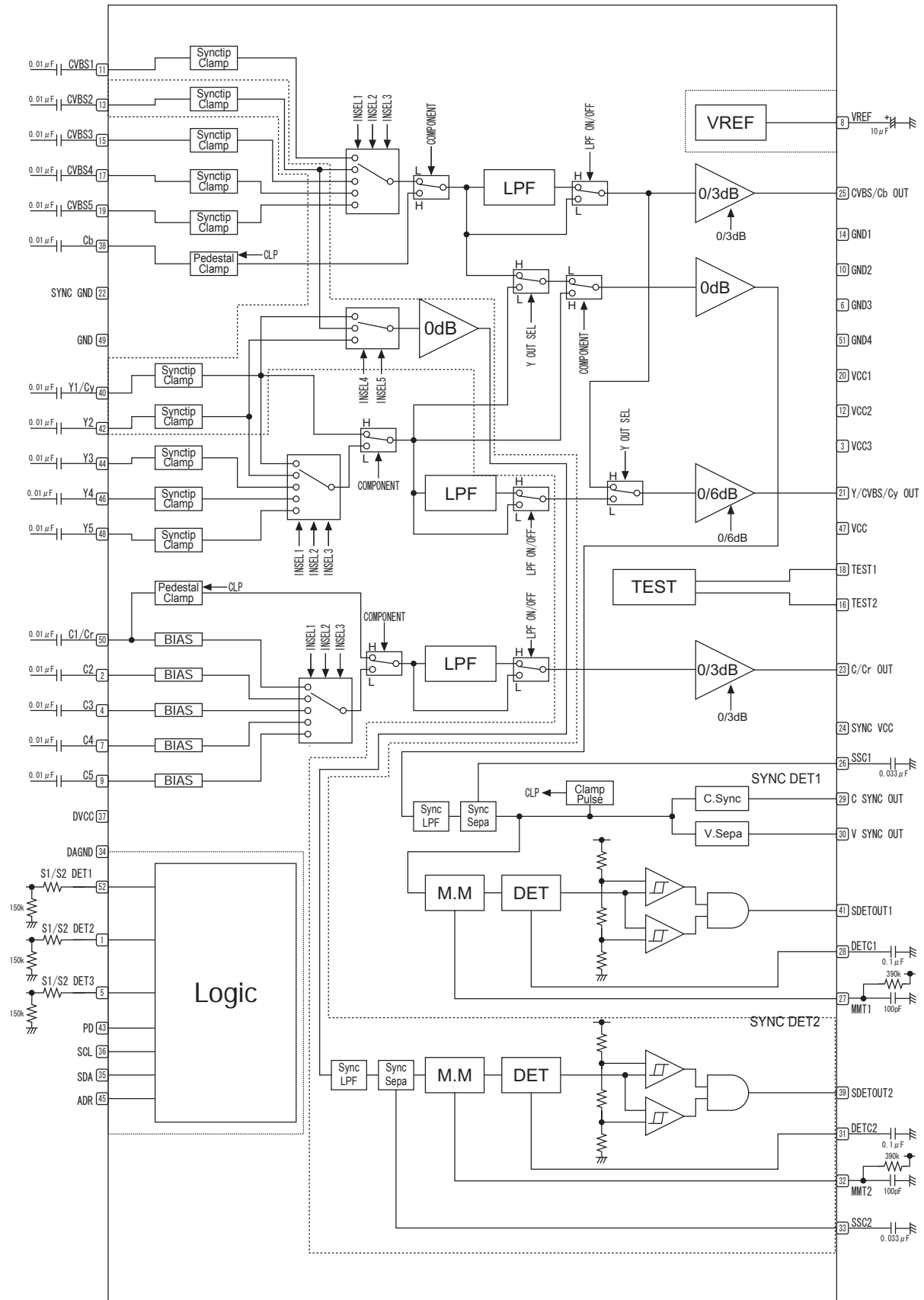

Fig.3

●Description of external components

- ① Video signal terminal (Clamp terminal)  
Use a capacitor above 0.01 $\mu$ F. If a capacitor is too small, a video signal may become distorted.
- ② Video signal input terminal (Bias terminal)  
Input impedance is 20k $\Omega$ (TYP) with this terminal. Therefore, set so that a chroma signal may pass fully.
- ③ S1/S2 DET terminal

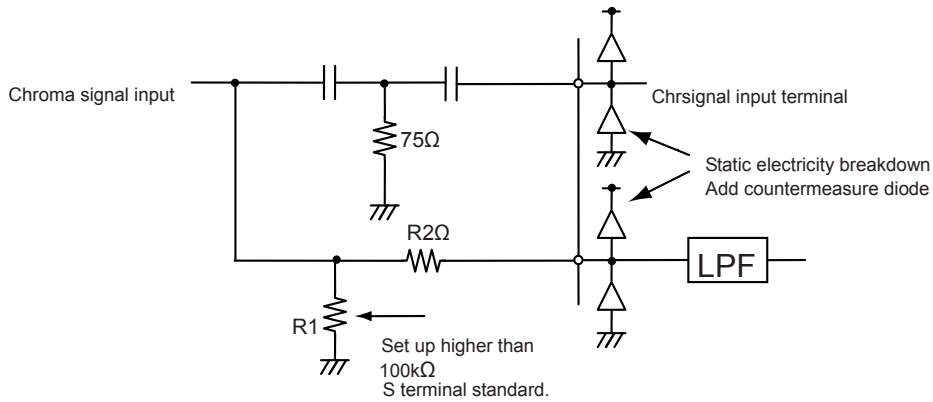

Fig.4

R2: Overvoltage transient can affect the static electricity protection diode connected to the VCC side. Therefore, add a limit current resistor (R2).

- ④ SSC terminal  
This terminal sets the sensitivity of the sync-tip level detection.  
When a capacitor is large, sensitivity becomes low, but becomes too sensitive when the capacitor is small.  
But, when it is too small, it becomes poor at the noise.
- ⑤ MMT  
Adjusting the value of the outside RC, and duty of the pulse output in DETC is set.  
(Pulse can be monitored when the capacitor of DETC is removed.)  
Set duty to 50%~60% in the state so that there is no noise in the input signal.  
The duty is not equal to the same time constant (RC=constant) when R is small.
- ⑥ DETC  
When a capacitor is small, detection reaction becomes fast, When it is large, detection reaction becomes slow.  
Pulse is smoothed by the output impedance of 100k $\Omega$  and a capacitor connected to this terminal.  
The status of the video signal is monitored by this DC voltage value.

● Reference data

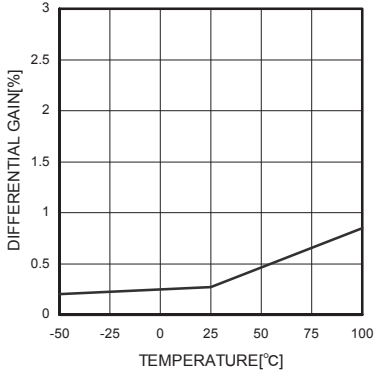

Fig.5 Differential Gain

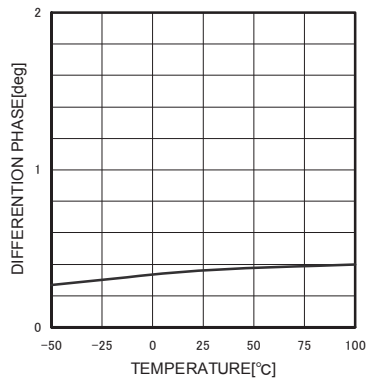

Fig.6 Differential Phase

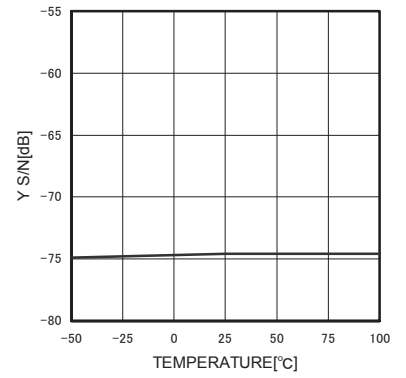

Fig.7 Y S/N ratio

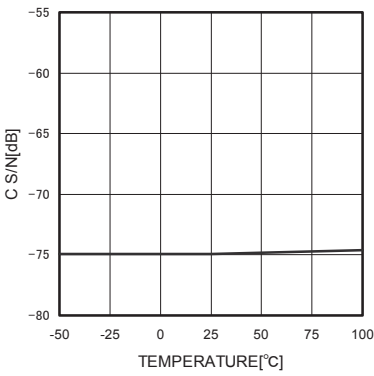

Fig.8 C S/N ratio

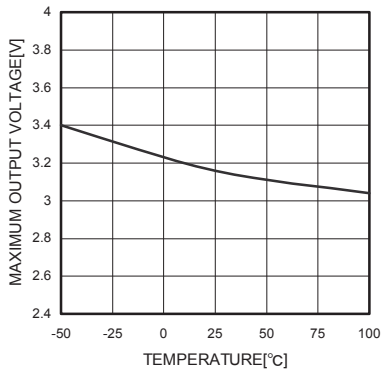

Fig.9 Maximum output voltage (Temperature dependence)

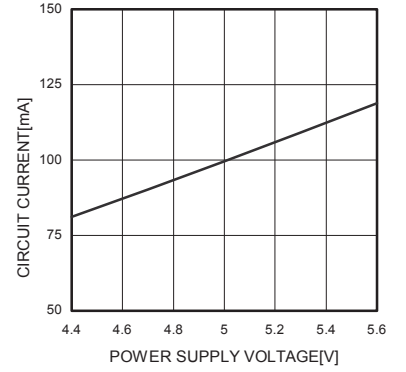

Fig.10 VCC Circuit current (Supply voltage dependence)

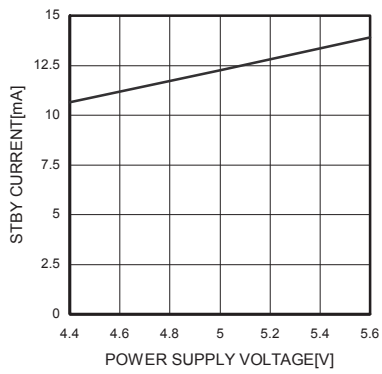

Fig.11 VCC Circuit current (STBY) (Supply voltage dependence)

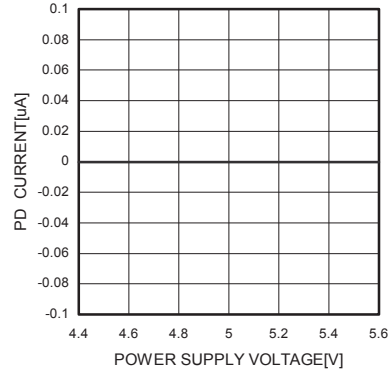

Fig.12 VCC Circuit current (PD) (Supply voltage dependence)

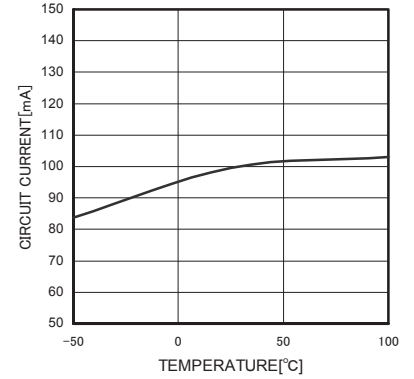

Fig.13 VCC Circuit current (Temperature dependence)

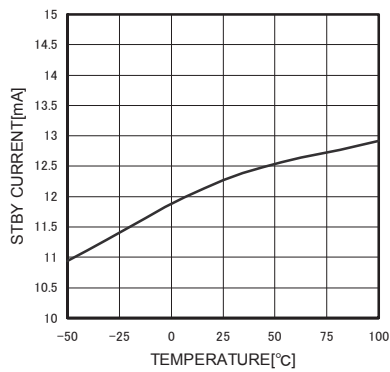

Fig.14 VCC Circuit current (Temperature dependence)

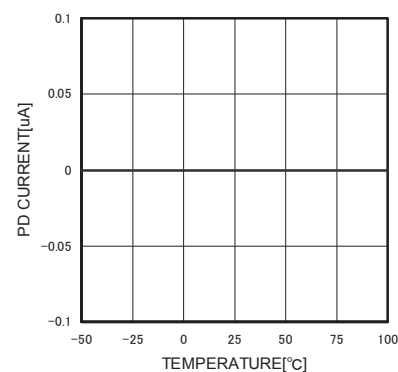

Fig.15 VCC Circuit current PD (Temperature dependence)

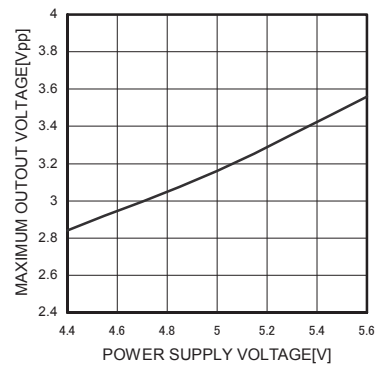

Fig.16 Maximum output voltage (Supply voltage dependence)

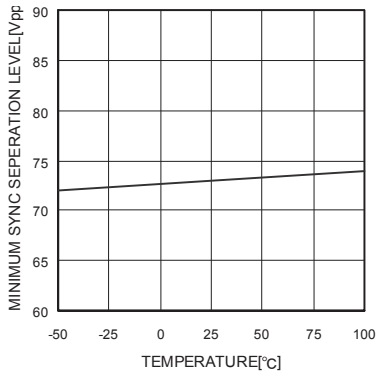

Fig. 17 Min synchronous isolation level (Temperature dependence)

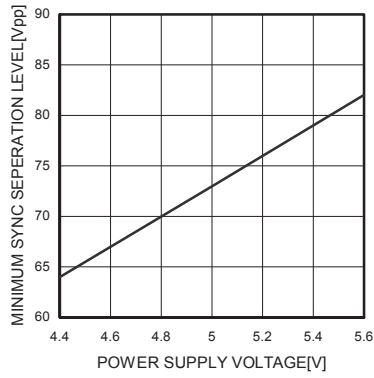

Fig. 18 Min synchronous isolation level (Supply voltage dependence)

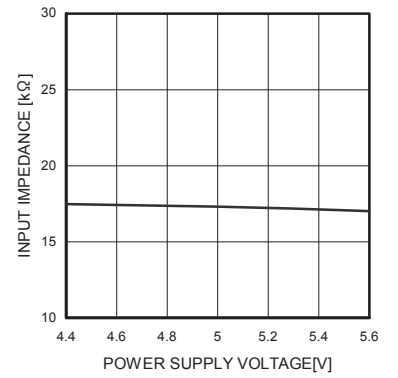

Fig. 19 CIN input impedance (Supply voltage dependence)

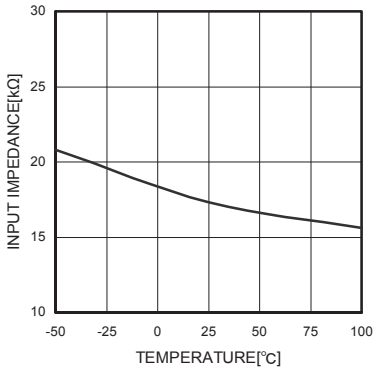

Fig. 20 CIN input impedance (Temperature dependence)

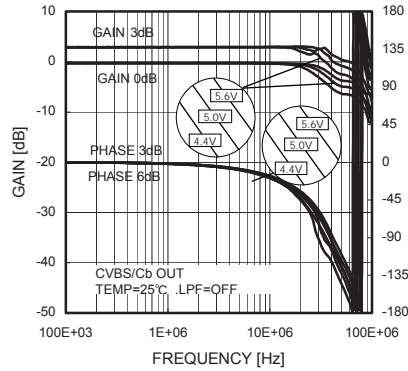

Fig. 21 Frequency characteristic (Supply voltage dependence)

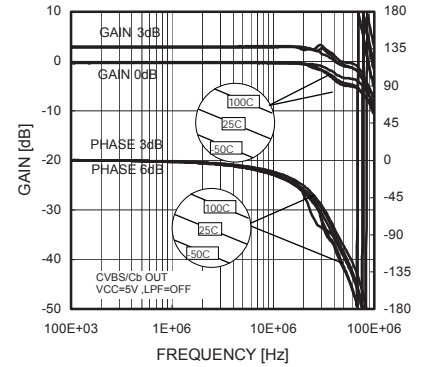

Fig. 22 Frequency characteristic (Temperature dependence)

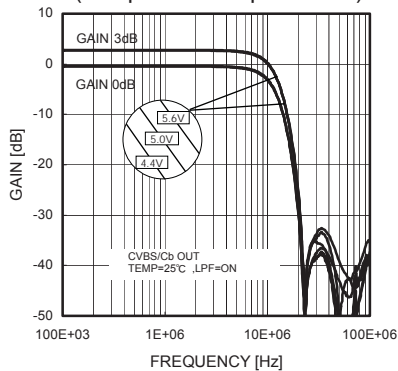

Fig. 23 Frequency characteristic (Supply voltage dependence)

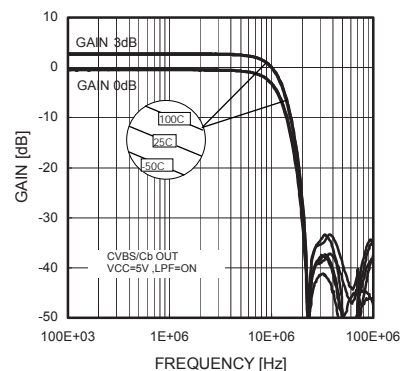

Fig. 24 Frequency characteristic (Temperature dependence)

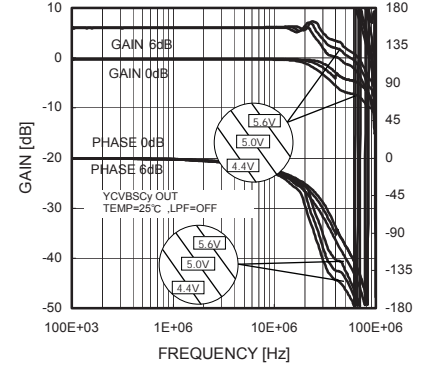

Fig. 25 Frequency characteristic (Supply voltage dependence)

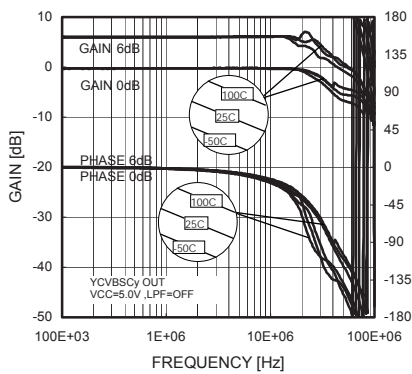

Fig. 26 Frequency characteristic (Temperature dependence)

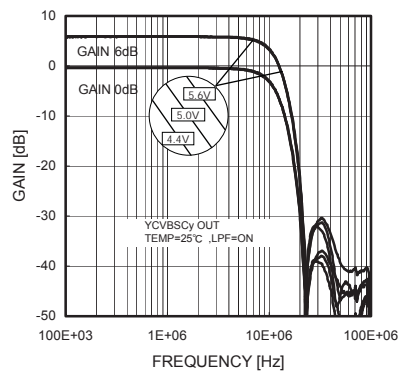

Fig. 27 Frequency characteristic (Supply voltage dependence)

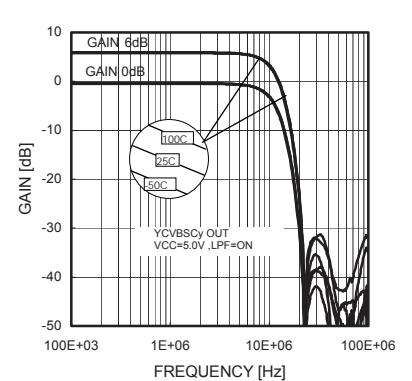

Fig. 28 Frequency characteristic (Temperature dependence)

## ●Cautions on use

1. Numbers and data in entries are representative design values and are not guaranteed values of the items.
2. Although ROHM is confident that the example application circuit reflects the best possible recommendations, be sure to verify circuit characteristics for your particular application. Modification of constants for other externally connected circuits may cause variations in both static and transient characteristics for external components as well as this Rohm IC. Allow for sufficient margins when determining circuit constants.
3. Absolute maximum ratings  
Use of the IC in excess of absolute maximum ratings, such as the applied voltage or operating temperature range (Topr), may result in IC damage. Assumptions should not be made regarding the state of the IC (short mode or open mode) when such damage is suffered. A physical safety measure, such as a fuse, should be implemented when using the IC at times where the absolute maximum ratings may be exceeded.
4. GND potential  
Ensure a minimum GND pin potential in all operating conditions. Make sure that no pins are at a voltage below the GND at any time, regardless of whether it is a transient signal or not.
5. Thermal design  
Perform thermal design, in which there are adequate margins, by taking into account the permissible dissipation (Pd) in actual states of use.
6. Short circuit between terminals and erroneous mounting  
Pay attention to the assembly direction of the ICs. Wrong mounting direction or shorts between terminals, GND, or other components on the circuits, can damage the IC.
7. Operation in strong electromagnetic field  
Using the ICs in a strong electromagnetic field can cause operation malfunction.
8. Supply voltage of operation  
Although basic circuit function is guaranteed under normal voltage operation (4.75V~5.25V), ensure each parameter complies with appropriate electrical characteristics, when using this device.
9. The outside parts must be layout nearest to the IC and lines from amplifier must be short.
10. The coupling capacitor must be layout nearest to the IC and each pin.
11. VCC for this IC should use the same power source. Impedance should be connected as low as possible for each VCC pin and for each GND pin.

## ●Thermal derating characteristics

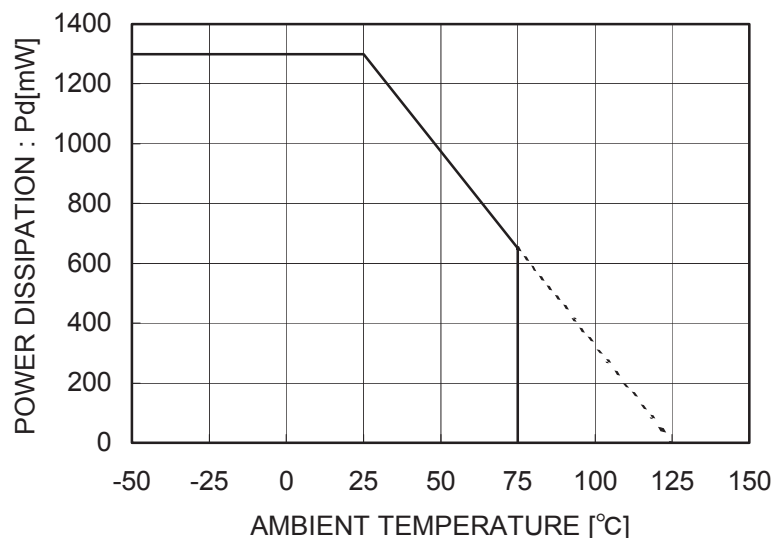

Fig. 29

● Selection of order type

B
H
7
6
2
5
K
S
2

TYPE

BH7625KS2

**SQFP-T52**

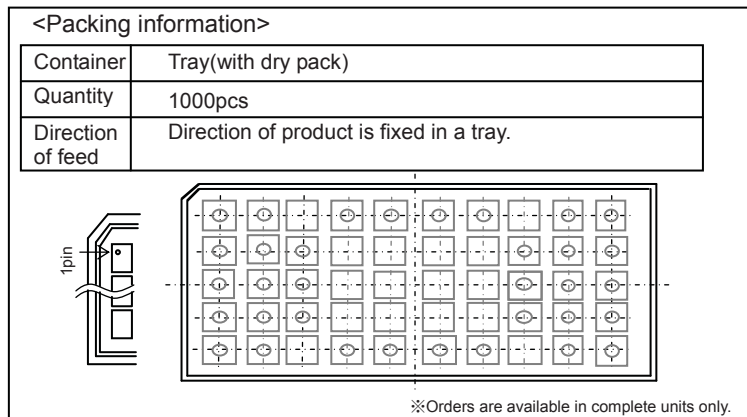
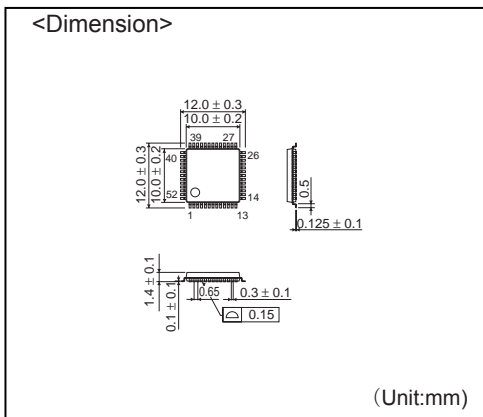

- The contents described herein are correct as of October, 2005
- The contents described herein are subject to change without notice. For updates of the latest information, please contact and confirm with ROHM CO.,LTD.
- Any part of this application note must not be duplicated or copied without our permission.
- Application circuit diagrams and circuit constants contained herein are shown as examples of standard use and operation. Please pay careful attention to the peripheral conditions when designing circuits and deciding upon circuit constants in the set.
- Any data, including, but not limited to application circuit diagrams and information, described herein are intended only as illustrations of such devices and not as the specifications for such devices. ROHM CO.,LTD. disclaims any warranty that any use of such devices shall be free from infringement of any third party's intellectual property rights or other proprietary rights, and further, assumes no liability of whatsoever nature in the event of any such infringement, or arising from or connected with or related to the use of such devices.
- Upon the sale of any such devices, other than for buyer's right to use such devices itself, resell or otherwise dispose of the same, implied right or license to practice or commercially exploit any intellectual property rights or other proprietary rights owned or controlled by ROHM CO., LTD. is granted to any such buyer.
- The products described herein utilize silicon as the main material.
- The products described herein are not designed to be X ray proof.

The products listed in this catalog are designed to be used with ordinary electronic equipment or devices (such as audio visual equipment, office-automation equipment, communications devices, electrical appliances and electronic toys). Should you intend to use these products with equipment or devices which require an extremely high level of reliability and the malfunction of which would directly endanger human life (such as medical instruments, transportation equipment, aerospace machinery, nuclear-reactor controllers, fuel controllers and other safety devices), please be sure to consult with our sales representative in advance.

Excellence in Electronics



**ROHM CO., LTD.**

21, Saiin Mizosaki-cho, Ukyo-ku, Kyoto  
615-8585, Japan  
TEL: (075)311-2121 FAX: (075)315-0172  
URL <http://www.rohm.com>

Published by  
Application Engineering Group

Contact us for further information about the products.

**Atlanta U.S.A. / ROHM ELECTRONICS ATLANTA SALES OFFICE**  
(DIVISION OF ROHM ELE.U.S.A.,LLC)  
TEL: +1(770)754-5972 FAX: +1(770)754-0691

**Dallas U.S.A. / ROHM ELECTRONICS DALLAS SALES OFFICE**  
(DIVISION OF ROHM ELE.U.S.A.,LLC)  
TEL: +1(972)312-8819 FAX: +1(972)312-0330

**San Diego U.S.A. / ROHM ELECTRONICS SAN DIEGO SALES OFFICE**  
(DIVISION OF ROHM ELE.U.S.A.,LLC)  
TEL: +1(858)625-3630 FAX: +1(858)625-3670

**Germany / ROHM ELECTRONICS GMBH (GERMANY)**  
TEL: +49(2154)9210 FAX: +49(2154)921400

**United Kingdom / ROHM ELECTRONICS GMBH (UK)**  
TEL: +44(0)1908-306700 FAX: +44(0)1908-235788

**France / ROHM ELECTRONICS GMBH (FRANCE)**  
TEL: +33(0)1 56 97 30 60 FAX: +33(0)1 56 97 30 80

**Hong Kong China / ROHM ELECTRONICS (H.K.) CO., LTD.**  
TEL: +852(2)7406262 FAX: +852(2)375-8971

**Shanghai China / ROHM ELECTRONICS (SHANGHAI) CO., LTD.**  
TEL: +86(21)6279-2727 FAX: +86(21)6247-2066

**Dalian China / ROHM ELECTRONICS TRADING (DALIAN) CO., LTD.**  
TEL: +86(411)8230-8549 FAX: +86(411)8230-8537

**Beijing China / BEIJING REPRESENTATIVE OFFICE**  
TEL: +86(10)8525-2483 FAX: +86(10)8525-2489

**Taiwan / ROHM ELECTRONICS TAIWAN CO., LTD.**  
TEL: +886(2)2500-6956 FAX: +886(2)2503-2869

**Korea / ROHM ELECTRONICS KOREA CORPORATION**  
TEL: +82(2)8182-7000 FAX: +82(2)8182-715

**Singapore / ROHM ELECTRONICS ASIA PTE.LTD. (RES/REI)**  
TEL: +65-6332-2322 FAX: +65-6332-5662

**Malaysia / ROHM ELECTRONICS (MALAYSIA) SDN. BHD.**  
TEL: +60(3)7958-8355 FAX: +60(3)7958-8377

**Philippines / ROHM ELECTRONICS (PHILIPPINES) SALES CORPORATION**  
TEL: +63(2)807-8872 FAX: +63(2)809-4422

**Thailand / ROHM ELECTRONICS (THAILAND) CO., LTD.**  
TEL: +66(2)254-4880 FAX: +66(2)256-6334



### Notes

- No technical content pages of this document may be reproduced in any form or transmitted by any means without prior permission of ROHM CO.,LTD.
- The contents described herein are subject to change without notice. The specifications for the product described in this document are for reference only. Upon actual use, therefore, please request that specifications to be separately delivered.
- Application circuit diagrams and circuit constants contained herein are shown as examples of standard use and operation. Please pay careful attention to the peripheral conditions when designing circuits and deciding upon circuit constants in the set.
- Any data, including, but not limited to application circuit diagrams information, described herein are intended only as illustrations of such devices and not as the specifications for such devices. ROHM CO.,LTD. disclaims any warranty that any use of such devices shall be free from infringement of any third party's intellectual property rights or other proprietary rights, and further, assumes no liability of whatsoever nature in the event of any such infringement, or arising from or connected with or related to the use of such devices.
- Upon the sale of any such devices, other than for buyer's right to use such devices itself, resell or otherwise dispose of the same, no express or implied right or license to practice or commercially exploit any intellectual property rights or other proprietary rights owned or controlled by
- ROHM CO., LTD. is granted to any such buyer.
- Products listed in this document are no antiradiation design.

The products listed in this document are designed to be used with ordinary electronic equipment or devices (such as audio visual equipment, office-automation equipment, communications devices, electrical appliances and electronic toys).

Should you intend to use these products with equipment or devices which require an extremely high level of reliability and the malfunction of which would directly endanger human life (such as medical instruments, transportation equipment, aerospace machinery, nuclear-reactor controllers, fuel controllers and other safety devices), please be sure to consult with our sales representative in advance.

It is our top priority to supply products with the utmost quality and reliability. However, there is always a chance of failure due to unexpected factors. Therefore, please take into account the derating characteristics and allow for sufficient safety features, such as extra margin, anti-flammability, and fail-safe measures when designing in order to prevent possible accidents that may result in bodily harm or fire caused by component failure. ROHM cannot be held responsible for any damages arising from the use of the products under conditions out of the range of the specifications or due to non-compliance with the NOTES specified in this catalog.

Thank you for your accessing to ROHM product informations.

More detail product informations and catalogs are available, please contact your nearest sales office.

**ROHM** Customer Support System

THE AMERICAS / EUROPE / ASIA / JAPAN

[www.rohm.com](http://www.rohm.com)

Contact us : [webmaster@rohm.co.jp](mailto:webmaster@rohm.co.jp)