

### FEATURES

**Very low supply current: 13  $\mu$ A**  
**Low offset voltage: 15  $\mu$ V maximum**  
**Offset voltage drift: 20 nV/ $^{\circ}$ C**  
**Single-supply operation: 1.8 V to 5.5 V**  
**High PSRR: 110 dB minimum**  
**High CMRR: 110 dB minimum**  
**Rail-to-rail input and output**  
**Unity gain stable**  
**Extended industrial temperature range**

### APPLICATIONS

**Pressure and position sensors**  
**Temperature measurements**  
**Electronic scales**  
**Medical instrumentation**  
**Battery-powered equipment**  
**Handheld test equipment**

### GENERAL DESCRIPTION

The ADA4051-2 is a CMOS, micropower, zero-drift operational amplifier utilizing an innovative chopping technique. This amplifier features rail-to-rail input and output swing and extremely low offset voltage while operating from a 1.8 V to 5.5 V power supply. This amplifier also offers high PSRR and CMRR, while operating with a supply current of only 13  $\mu$ A per amplifier. This combination of features makes the ADA4051-2 amplifier an ideal choice for battery-powered applications where high precision as well as low power consumption is important. The ADA4051-2 is specified for the extended industrial temperature range of  $-40^{\circ}$ C to  $+125^{\circ}$ C. The ADA4051-2 amplifier is available in the standard 8-pin MSOP.

### PIN CONFIGURATION



Figure 1. 8-Lead MSOP (RM-8)

The ADA4051-2 is a member of a growing series of zero-drift op amps offered by Analog Devices, Inc. Refer to Table 1 for a list of these devices.

Table 1. Op Amps

Supple	Low Power, 5 V	5 V	16 V
Single	<a href="#">AD8538</a>	<a href="#">AD8628</a>	<a href="#">AD8638</a>
Dual	<a href="#">AD8539</a>	<a href="#">AD8629</a>	<a href="#">AD8639</a>
Quad		<a href="#">AD8630</a>	

#### Rev. 0

Information furnished by Analog Devices is believed to be accurate and reliable. However, no responsibility is assumed by Analog Devices for its use, nor for any infringements of patents or other rights of third parties that may result from its use. Specifications subject to change without notice. No license is granted by implication or otherwise under any patent or patent rights of Analog Devices. Trademarks and registered trademarks are the property of their respective owners.

## TABLE OF CONTENTS

Features .....	1	Thermal Resistance .....	5
Applications.....	1	Power Sequencing .....	5
Pin Configuration.....	1	ESD Caution.....	5
General Description .....	1	Typical Performance Characteristics .....	6
Revision History .....	2	Theory of Operation .....	15
Specifications.....	3	Input Voltage Range.....	16
Electrical Characteristics—5 V Operation.....	3	Output Phase Reversal.....	17
Electrical Characteristics—1.8 V Operation .....	4	Outline Dimensions .....	18
Absolute Maximum Ratings.....	5	Ordering Guide .....	18

## REVISION HISTORY

7/09—Revision 0: Initial Version

# SPECIFICATIONS

## ELECTRICAL CHARACTERISTICS—5 V OPERATION

$V_{SY} = 5.0\text{ V}$ ,  $V_{CM} = V_{SY}/2$  V,  $T_A = 25^\circ\text{C}$ , unless otherwise noted.

Table 2.

Parameter	Symbol	Conditions	Min	Typ	Max	Unit
<b>INPUT CHARACTERISTICS</b>						
Offset Voltage	$V_{OS}$	$0\text{ V} \leq V_{CM} \leq 5\text{ V}$		2	15	$\mu\text{V}$
Offset Voltage Drift	$\Delta V_{OS}/\Delta T$	$-40^\circ\text{C} \leq T_A \leq +125^\circ\text{C}$		0.02	0.1	$\mu\text{V}/^\circ\text{C}$
Input Bias Current	$I_B$	$-40^\circ\text{C} \leq T_A \leq +125^\circ\text{C}$		20	70	$\text{pA}$
Input Offset Current	$I_{OS}$	$-40^\circ\text{C} \leq T_A \leq +125^\circ\text{C}$			200	$\text{pA}$
		$-40^\circ\text{C} \leq T_A \leq +125^\circ\text{C}$		40	100	$\text{pA}$
		$-40^\circ\text{C} \leq T_A \leq +125^\circ\text{C}$			150	$\text{pA}$
Input Voltage Range		$-40^\circ\text{C} \leq T_A \leq +125^\circ\text{C}$	0		5	V
Common-Mode Rejection Ratio	CMRR	$0\text{ V} \leq V_{CM} \leq 5\text{ V}$	110	135		dB
		$-40^\circ\text{C} \leq T_A \leq +125^\circ\text{C}$	106			dB
Large-Signal Voltage Gain	$A_{VO}$	$R_L = 10\text{ k}\Omega$ , $0.1\text{ V} \leq V_{OUT} \leq V_{SY} - 0.1\text{ V}$	115	135		dB
		$-40^\circ\text{C} \leq T_A \leq +125^\circ\text{C}$	106			dB
Input Resistance	$R_{IN}$			8		$\text{M}\Omega$
Input Capacitance, Differential Mode	$C_{INDM}$			2		$\text{pF}$
Input Capacitance, Common Mode	$C_{INCM}$			5		$\text{pF}$
<b>OUTPUT CHARACTERISTICS</b>						
Output Voltage High	$V_{OH}$	$R_L = 10\text{ k}\Omega$ to $V_{CM}$	4.96	4.99		V
		$-40^\circ\text{C} \leq T_A \leq +125^\circ\text{C}$	4.9			V
		$R_L = 100\text{ k}\Omega$ to $V_{CM}$	4.996	4.998		V
		$-40^\circ\text{C} \leq T_A \leq +125^\circ\text{C}$	4.985			V
Output Voltage Low	$V_{OL}$	$R_L = 10\text{ k}\Omega$ to $V_{CM}$		9	30	mV
		$-40^\circ\text{C} \leq T_A \leq +125^\circ\text{C}$			90	mV
		$R_L = 100\text{ k}\Omega$ to $V_{CM}$		1	4	mV
		$-40^\circ\text{C} \leq T_A \leq +125^\circ\text{C}$			13	mV
Short-Circuit Current	$I_{SC}$	$V_{OUT} = V_{SY}$ or GND		15		$\text{mA}$
Closed-Loop Output Impedance	$Z_{OUT}$	$f = 1\text{ kHz}$ , $G = 10$		1		$\Omega$
<b>POWER SUPPLY</b>						
Power Supply Rejection Ratio	PSRR	$1.8\text{ V} \leq V_{SY} \leq 5.5\text{ V}$	110	135		dB
		$-40^\circ\text{C} \leq T_A \leq +125^\circ\text{C}$	106			dB
Supply Current per Amplifier	$I_{SY}$	$V_{OUT} = V_{SY}/2$		13	17	$\mu\text{A}$
		$-40^\circ\text{C} \leq T_A \leq +125^\circ\text{C}$			20	$\mu\text{A}$
<b>DYNAMIC PERFORMANCE</b>						
Slew Rate	$SR^+$	$R_L = 10\text{ k}\Omega$ , $C_L = 100\text{ pF}$ , $G = 1$		0.06		$\text{V}/\mu\text{s}$
	$SR^-$	$R_L = 10\text{ k}\Omega$ , $C_L = 100\text{ pF}$ , $G = 1$		0.04		$\text{V}/\mu\text{s}$
Settling Time	$t_s$	To 0.1%, $V_{IN} = 1\text{ V p-p}$ , $R_L = 10\text{ k}\Omega$ , $C_L = 100\text{ pF}$		110		$\mu\text{s}$
Gain Bandwidth Product	GBP	$C_L = 100\text{ pF}$ , $G = 1$		125		$\text{kHz}$
Phase Margin	$\Phi_M$	$C_L = 100\text{ pF}$ , $G = 1$		40		Degrees
Channel Separation	CS	$V_{IN} = 4.99\text{ V}$ , $f = 100\text{ Hz}$		140		dB
<b>NOISE PERFORMANCE</b>						
Voltage Noise	$e_n$ p-p	$f = 0.1\text{ Hz}$ to $10\text{ Hz}$		1.96		$\mu\text{V p-p}$
Voltage Noise Density	$e_n$	$f = 1\text{ kHz}$		95		$\text{nV}/\sqrt{\text{Hz}}$
Current Noise Density	$i_n$	$f = 1\text{ kHz}$		100		$\text{fA}/\sqrt{\text{Hz}}$

# ADA4051-2

## ELECTRICAL CHARACTERISTICS—1.8 V OPERATION

$V_{SY} = 1.8 \text{ V}$ ,  $V_{CM} = V_{SY}/2 \text{ V}$ ,  $T_A = 25^\circ\text{C}$ , unless otherwise noted.

Table 3.

Parameter	Symbol	Conditions	Min	Typ	Max	Unit
<b>INPUT CHARACTERISTICS</b>						
Offset Voltage	$V_{OS}$	$0 \text{ V} \leq V_{CM} \leq 1.8 \text{ V}$		2	15	$\mu\text{V}$
Offset Voltage Drift	$\Delta V_{OS}/\Delta T$	$-40^\circ\text{C} \leq T_A \leq +125^\circ\text{C}$		0.02	0.1	$\mu\text{V}/^\circ\text{C}$
Input Bias Current	$I_B$	$-40^\circ\text{C} \leq T_A \leq +125^\circ\text{C}$		5	50	pA
Input Offset Current	$I_{OS}$	$-40^\circ\text{C} \leq T_A \leq +125^\circ\text{C}$		10	100	pA
Input Voltage Range		$-40^\circ\text{C} \leq T_A \leq +125^\circ\text{C}$	0		150	pA
Common-Mode Rejection Ratio	CMRR	$0 \text{ V} \leq V_{CM} \leq 1.8 \text{ V}$	105	125	1.8	V
Large-Signal Voltage Gain	$A_{VO}$	$R_L = 10 \text{ k}\Omega$ , $0.1 \text{ V} \leq V_{OUT} \leq V_{SY} - 0.1 \text{ V}$	100	130		dB
Input Resistance	$R_{IN}$	$-40^\circ\text{C} \leq T_A \leq +125^\circ\text{C}$	100			dB
Input Capacitance, Differential Mode	$C_{INDM}$			8		$\text{M}\Omega$
Input Capacitance, Common Mode	$C_{INCM}$			2		pF
				5		pF
<b>OUTPUT CHARACTERISTICS</b>						
Output Voltage High	$V_{OH}$	$R_L = 10 \text{ k}\Omega$ to $V_{CM}$	1.76	1.796		V
		$-40^\circ\text{C} \leq T_A \leq +125^\circ\text{C}$	1.7			V
		$R_L = 100 \text{ k}\Omega$ to $V_{CM}$	1.796	1.799		V
		$-40^\circ\text{C} \leq T_A \leq +125^\circ\text{C}$	1.79			V
Output Voltage Low	$V_{OL}$	$R_L = 10 \text{ k}\Omega$ to $V_{CM}$		3	20	mV
		$-40^\circ\text{C} \leq T_A \leq +125^\circ\text{C}$			40	mV
		$R_L = 100 \text{ k}\Omega$ to $V_{CM}$		1	3	mV
		$-40^\circ\text{C} \leq T_A \leq +125^\circ\text{C}$			9	mV
Short-Circuit Current	$I_{SC}$	$V_{OUT} = V_{SY}$ or GND		13		mA
Closed-Loop Output Impedance	$Z_{OUT}$	$f = 1 \text{ kHz}$ , $G = 10$		1		$\Omega$
<b>POWER SUPPLY</b>						
Power Supply Rejection Ratio	PSRR	$1.8 \text{ V} \leq V_{SY} \leq 5.5 \text{ V}$	110	135		dB
		$-40^\circ\text{C} \leq T_A \leq +125^\circ\text{C}$	106			dB
Supply Current per Amplifier	$I_{SY}$	$V_{OUT} = V_{SY}/2$		13	17	$\mu\text{A}$
		$-40^\circ\text{C} \leq T_A \leq +125^\circ\text{C}$			20	$\mu\text{A}$
<b>DYNAMIC PERFORMANCE</b>						
Slew Rate	$SR^+$	$R_L = 10 \text{ k}\Omega$ , $C_L = 100 \text{ pF}$ , $G = 1$		0.04		$\text{V}/\mu\text{s}$
	$SR^-$	$R_L = 10 \text{ k}\Omega$ , $C_L = 100 \text{ pF}$ , $G = 1$		0.03		$\text{V}/\mu\text{s}$
Settling Time	$t_s$	To 0.1%, $V_{IN} = 1 \text{ V p-p}$ , $R_L = 10 \text{ k}\Omega$ , $C_L = 100 \text{ pF}$		120		$\mu\text{s}$
Gain Bandwidth Product	GBP	$C_L = 100 \text{ pF}$ , $G = 1$		115		kHz
Phase Margin	$\Phi_M$	$C_L = 100 \text{ pF}$ , $G = 1$		40		Degrees
Channel Separation	CS	$V_{IN} = 1.7 \text{ V}$ , $f = 100 \text{ Hz}$		140		dB
<b>NOISE PERFORMANCE</b>						
Voltage Noise	$e_n \text{ p-p}$	$f = 0.1 \text{ Hz to } 10 \text{ Hz}$		1.96		$\mu\text{V p-p}$
Voltage Noise Density	$e_n$	$f = 1 \text{ kHz}$		95		$\text{nV}/\sqrt{\text{Hz}}$
Current Noise Density	$i_n$	$f = 1 \text{ kHz}$		100		$\text{fA}/\sqrt{\text{Hz}}$

## ABSOLUTE MAXIMUM RATINGS

Table 4.

Parameter	Rating
Supply Voltage	6 V
Input Voltage	$\pm V_{SY} \pm 0.3$ V
Input Current <sup>1</sup>	$\pm 10$ mA
Differential Input Voltage <sup>2</sup>	$\pm V_{SY}$
Output Short-Circuit Duration to GND	Indefinite
Storage Temperature Range	-65°C to +150°C
Operating Temperature Range	-40°C to +125°C
Junction Temperature Range	-65°C to +150°C
Lead Temperature (Soldering, 60 sec)	300°C

<sup>1</sup> The input pins have clamp diodes to the power supply pins. Limit input current to 10 mA or less whenever input signals exceed the power supply rail by 0.3 V.

<sup>2</sup> Inputs are protected against high differential voltages by internal series 1.33 kΩ resistors and back-to-back diode-connected N-MOSFETs (with a typical  $V_T$  of 0.7 V for  $V_{CM}$  of 0 V).

Stresses above those listed under Absolute Maximum Ratings may cause permanent damage to the device. This is a stress rating only; functional operation of the device at these or any other conditions above those indicated in the operational section of this specification is not implied. Exposure to absolute maximum rating conditions for extended periods may affect device reliability.

## THERMAL RESISTANCE

$\theta_{JA}$  is specified with the device soldered on a circuit board with its exposed paddle soldered to a pad (if applicable) on a 4-layer JEDEC standard PC board with zero air flow, unless otherwise specified.

Table 5. Thermal Resistance

Package Type	$\theta_{JA}$	$\theta_{JC}$	Unit
8-Lead MSOP (RM-8)	186	52	°C/W

## POWER SEQUENCING

The op amp supplies must be established simultaneously with, or before, any input signals are applied. If this is not possible, the input current must be limited to 10 mA.

## ESD CAUTION



**ESD (electrostatic discharge) sensitive device.** Charged devices and circuit boards can discharge without detection. Although this product features patented or proprietary protection circuitry, damage may occur on devices subjected to high energy ESD. Therefore, proper ESD precautions should be taken to avoid performance degradation or loss of functionality.

# TYPICAL PERFORMANCE CHARACTERISTICS

T<sub>A</sub> = 25°C, unless otherwise noted.

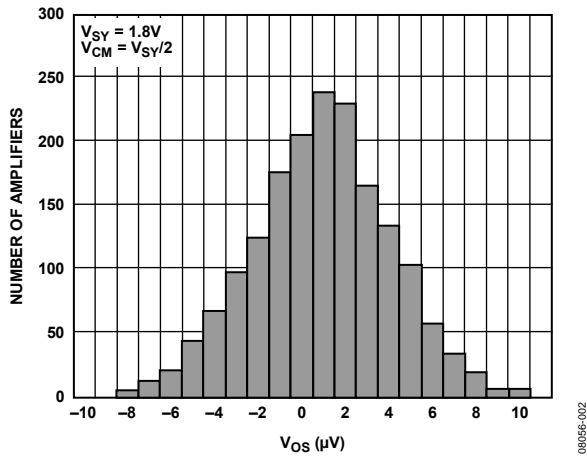

Figure 2. Input Offset Voltage Distribution

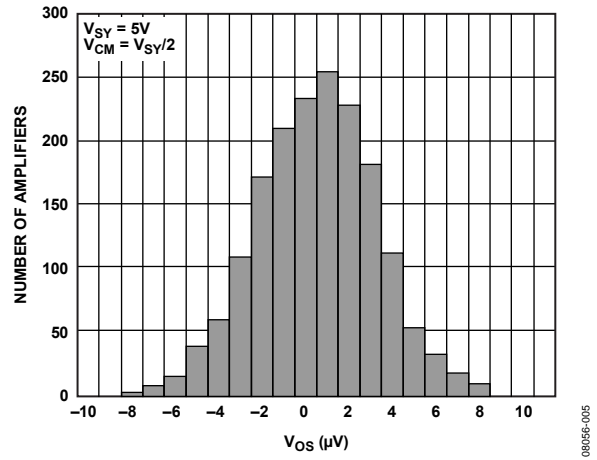

Figure 5. Input Offset Voltage Distribution

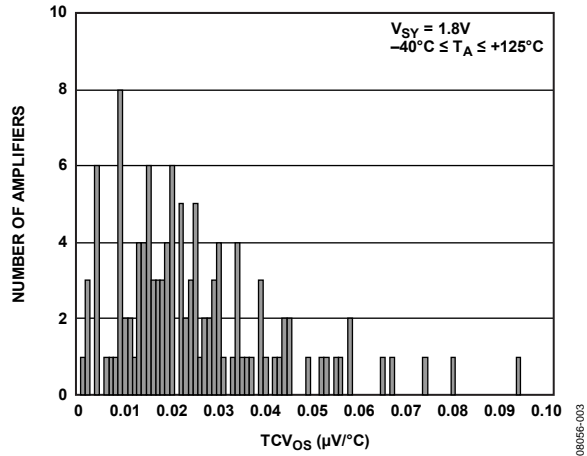

Figure 3. Input Offset Voltage Drift Distribution with Temperature

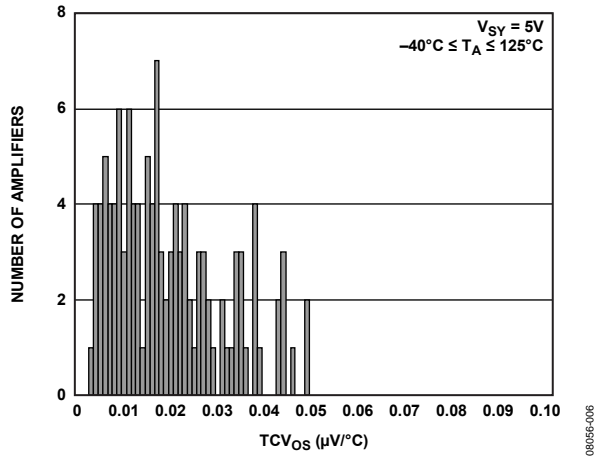

Figure 6. Input Offset Voltage Drift Distribution with Temperature

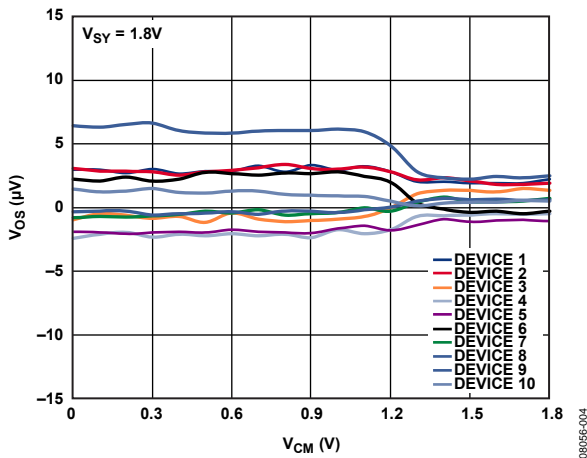

Figure 4. Input Offset Voltage vs. Input Common-Mode Voltage

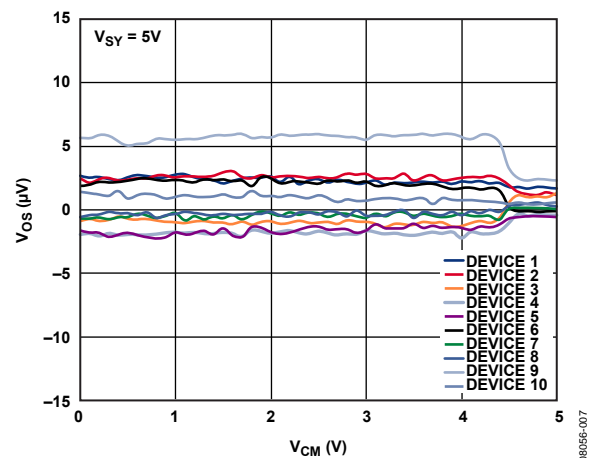

Figure 7. Input Offset Voltage vs. Input Common-Mode Voltage

T<sub>A</sub> = 25°C, unless otherwise noted.

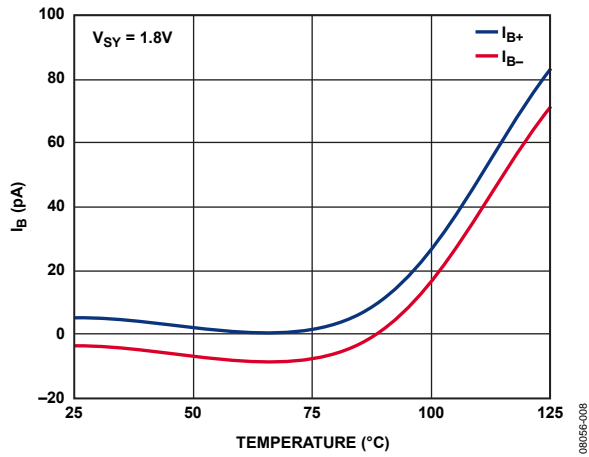

Figure 8. Input Bias Current vs. Temperature

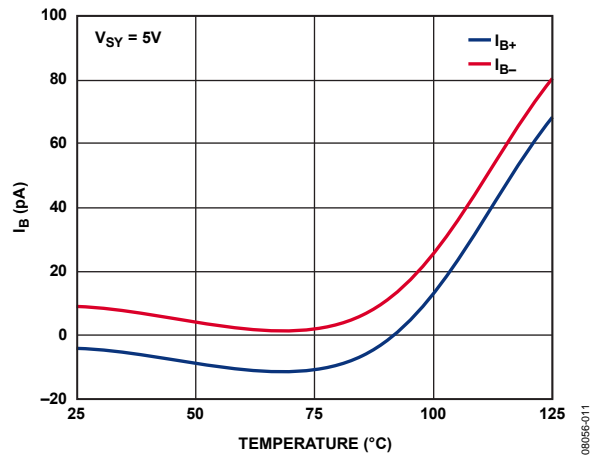

Figure 11. Input Bias Current vs. Temperature

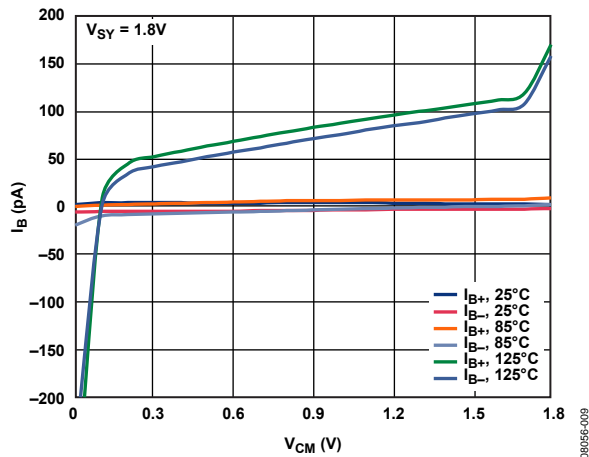

Figure 9. Input Bias Current vs. Common-Mode Voltage and Temperature

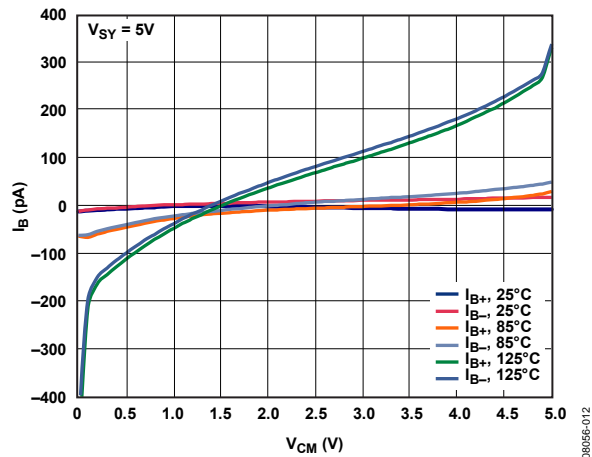

Figure 12. Input Bias Current vs. Common-Mode Voltage and Temperature

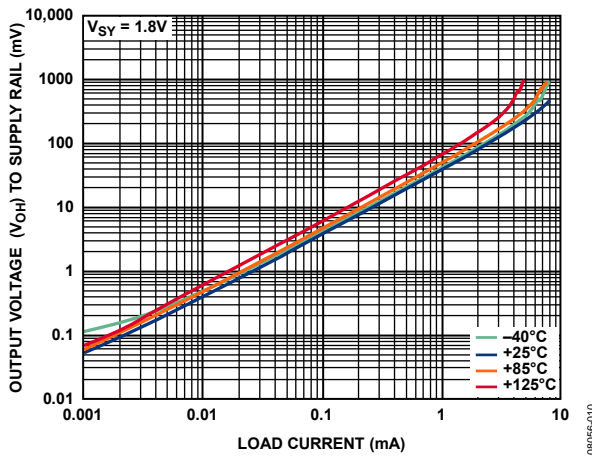

Figure 10. Output Voltage (V<sub>OH</sub>) to Supply Rail vs. Load Current and Temperature

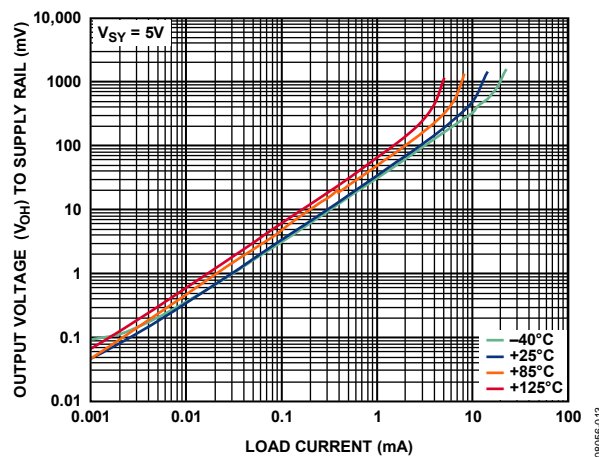

Figure 13. Output Voltage (V<sub>OH</sub>) to Supply Rail vs. Load Current and Temperature

# ADA4051-2

$T_A = 25^\circ\text{C}$ , unless otherwise noted.

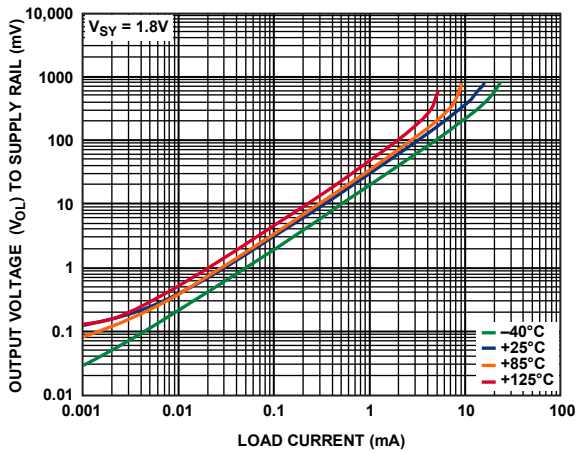

Figure 14. Output Voltage ( $V_{OL}$ ) to Supply Rail vs. Load Current and Temperature

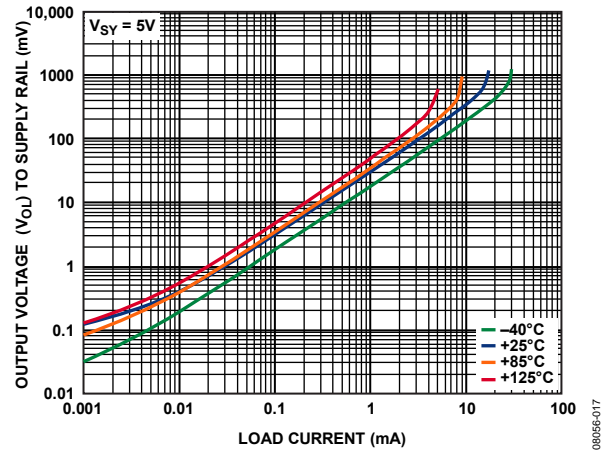

Figure 17. Output Voltage ( $V_{OL}$ ) to Supply Rail vs. Load Current and Temperature

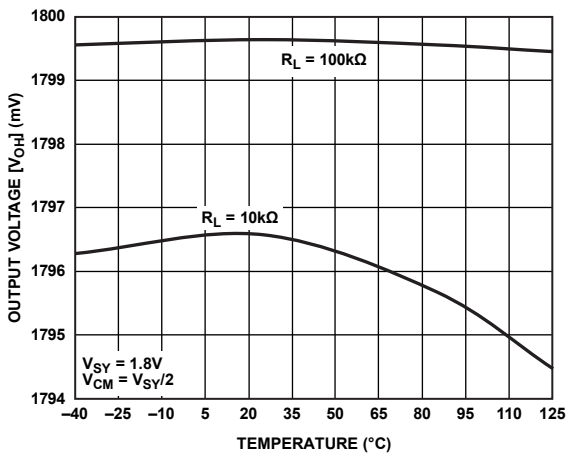

Figure 15. Output Voltage ( $V_{OH}$ ) vs. Temperature

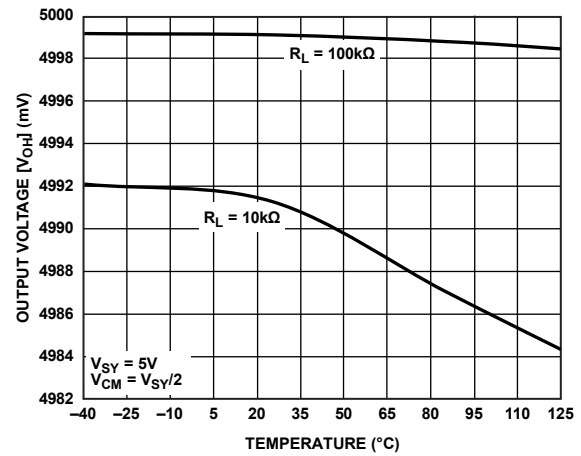

Figure 18. Output Voltage ( $V_{OH}$ ) vs. Temperature

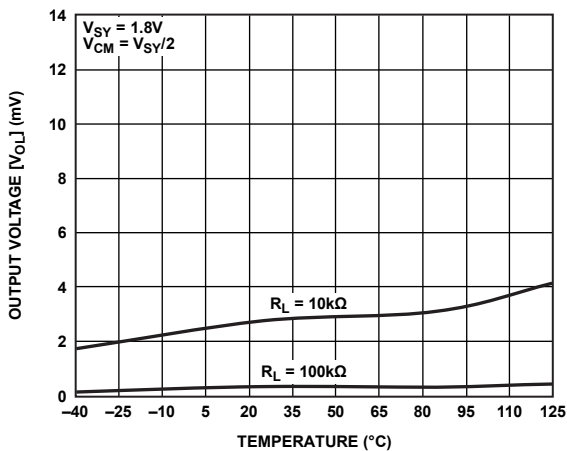

Figure 16. Output Voltage ( $V_{OL}$ ) vs. Temperature

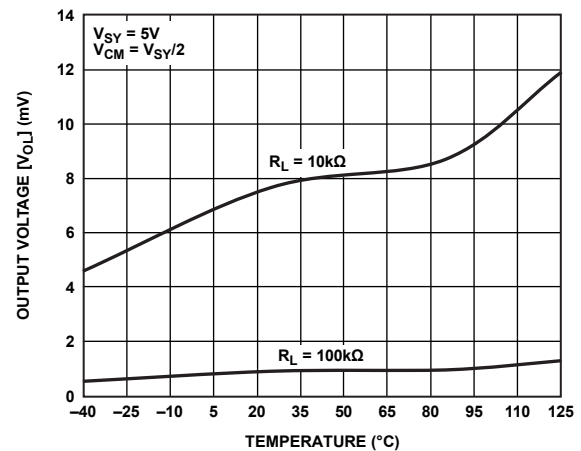

Figure 19. Output Voltage ( $V_{OL}$ ) vs. Temperature



$T_A = 25^\circ\text{C}$ , unless otherwise noted.

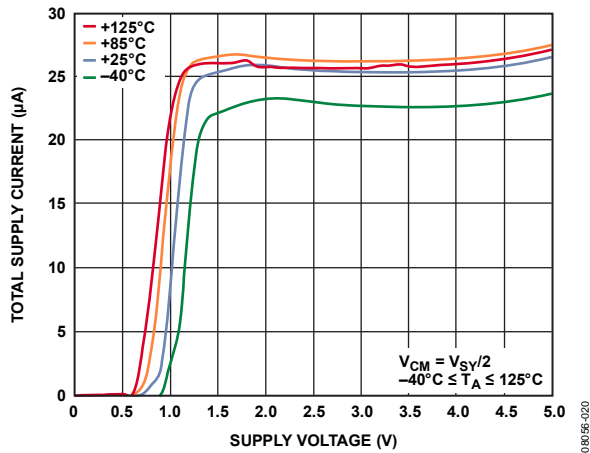

Figure 20. Total Supply Current vs. Supply Voltage and Temperature

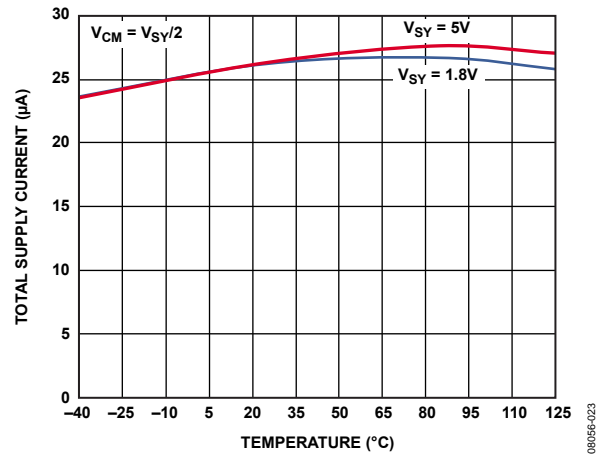

Figure 23. Total Supply Current vs. Temperature

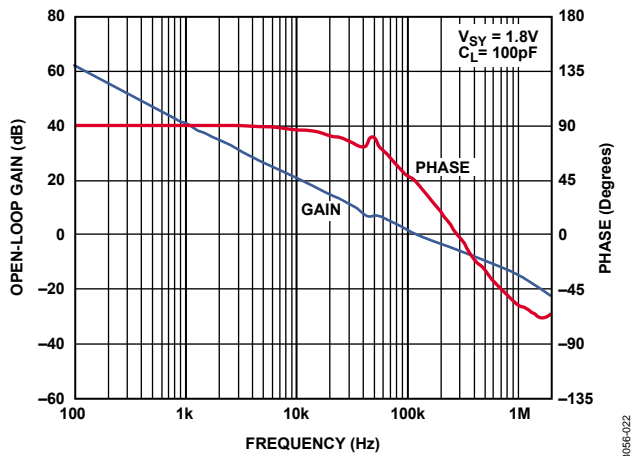

Figure 21. Open-Loop Gain and Phase vs. Frequency

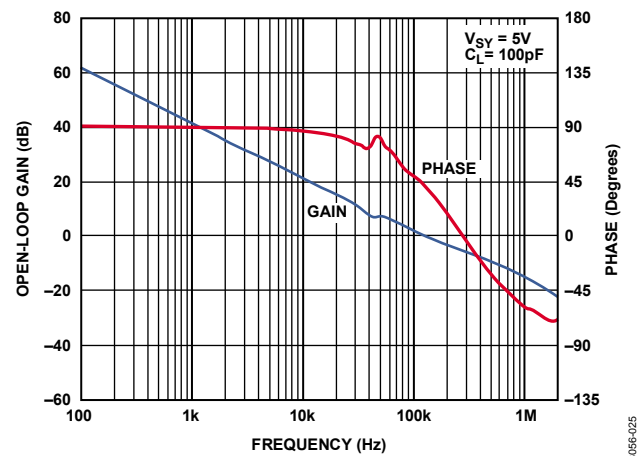

Figure 24. Open-Loop Gain and Phase vs. Frequency

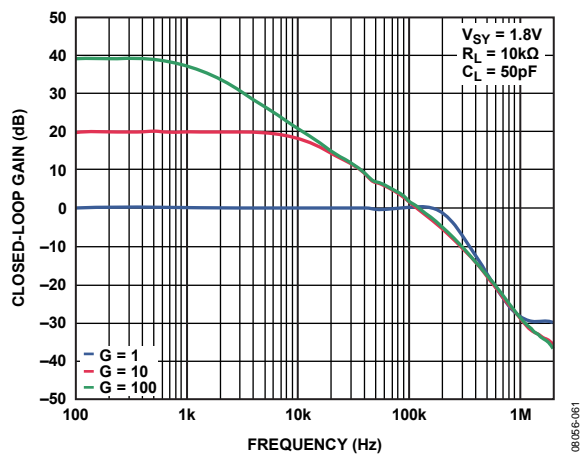

Figure 22. Closed-Loop Gain vs. Frequency

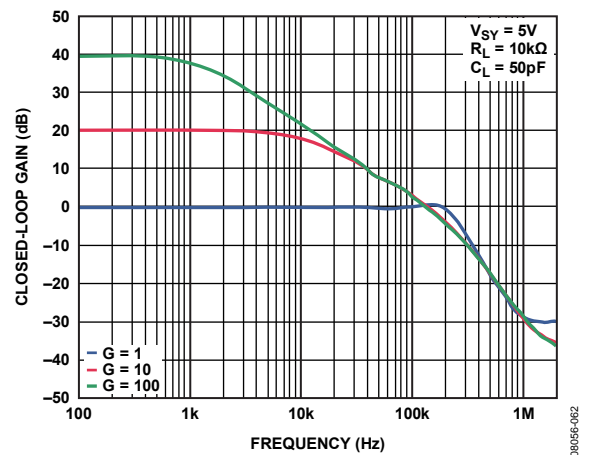

Figure 25. Closed-Loop Gain vs. Frequency

# ADA4051-2

$T_A = 25^\circ\text{C}$ , unless otherwise noted.

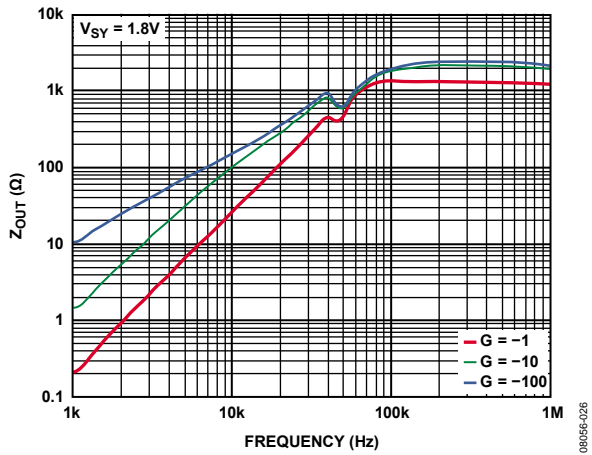

Figure 26. Output Impedance vs. Frequency

08056-026

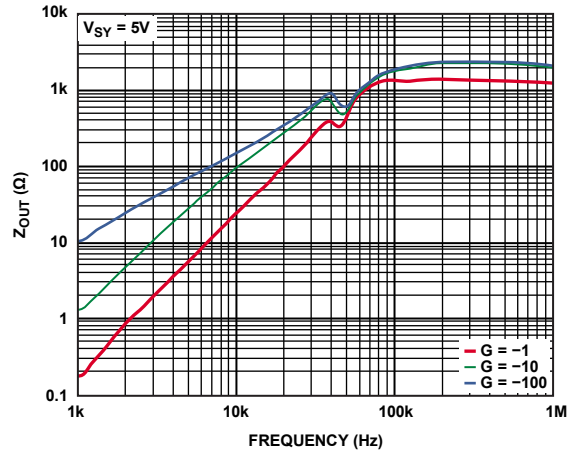

Figure 29. Output Impedance vs. Frequency

08056-029

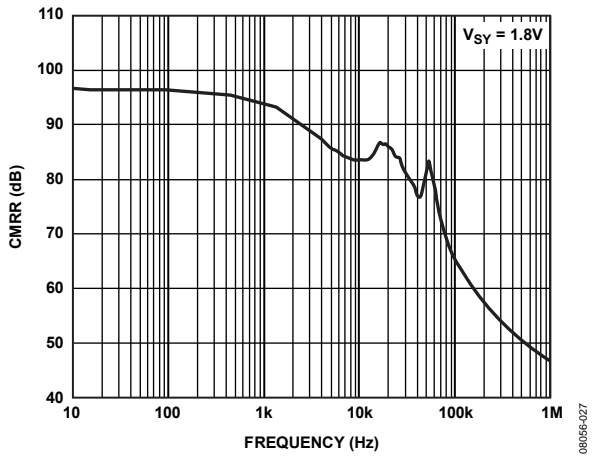

Figure 27. CMRR vs. Frequency

08056-027

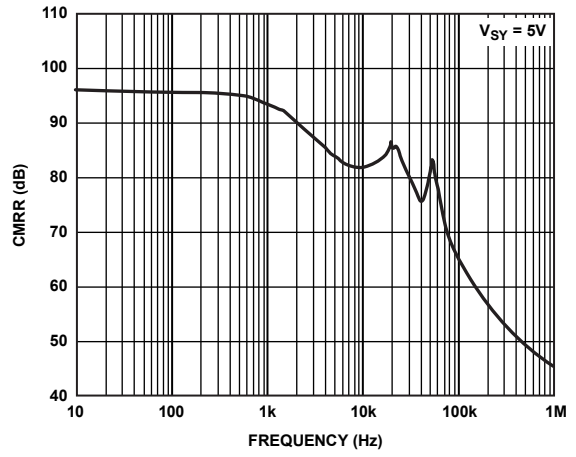

Figure 30. CMRR vs. Frequency

08056-030

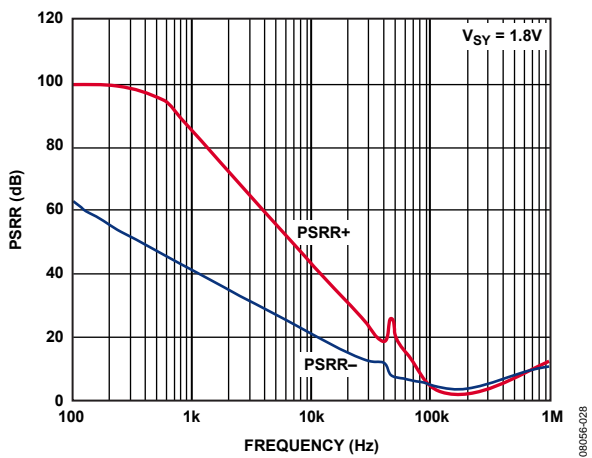

Figure 28. PSRR vs. Frequency

08056-028

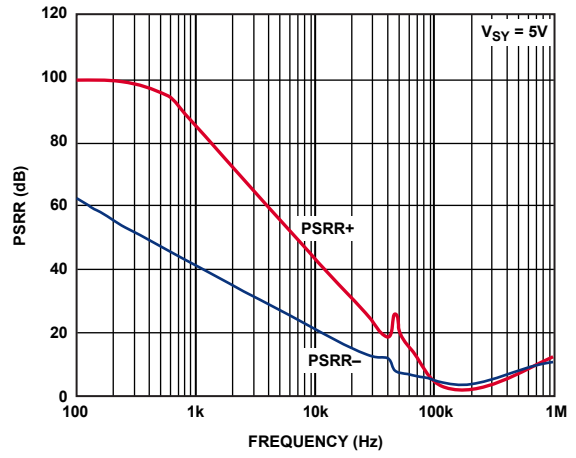

Figure 31. PSRR vs. Frequency

08056-031

T<sub>A</sub> = 25°C, unless otherwise noted.

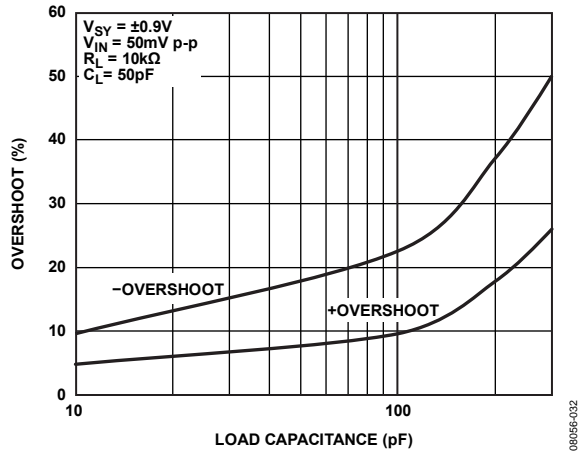

Figure 32. Small-Signal Overshoot vs. Load Capacitance

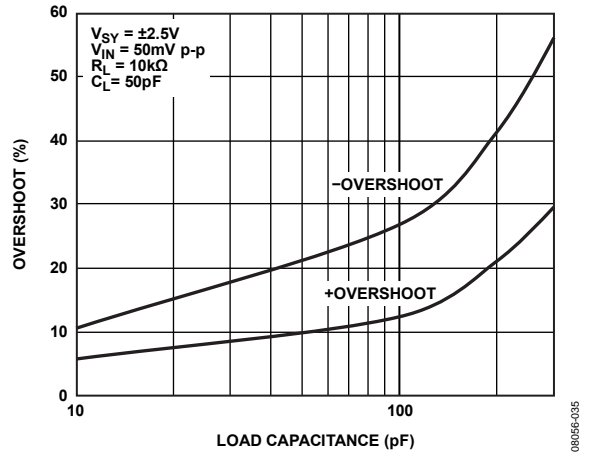

Figure 35. Small-Signal Overshoot vs. Load Capacitance

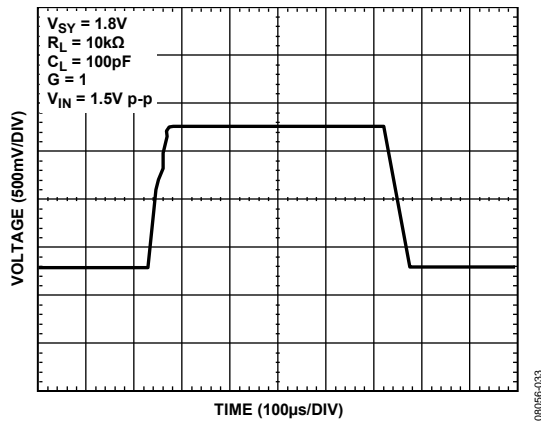

Figure 33. Large-Signal Transient Response

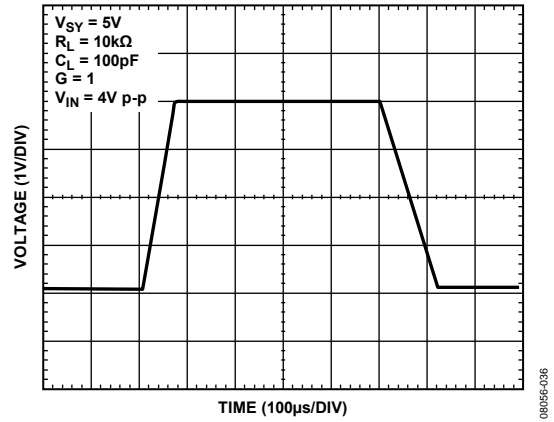

Figure 36. Large Signal Transient Response

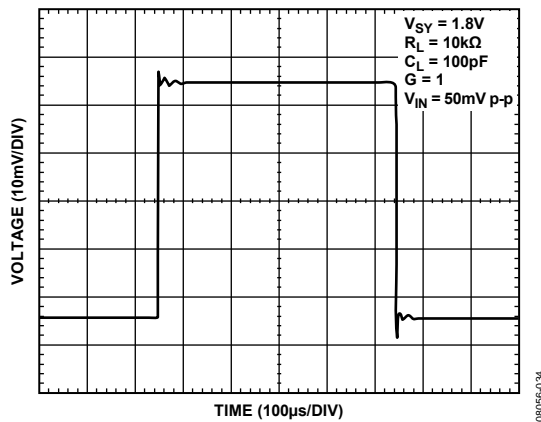

Figure 34. Small-Signal Transient Response

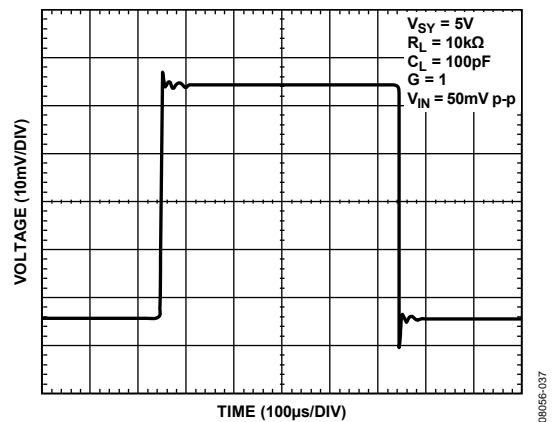

Figure 37. Small Signal Transient Response

# ADA4051-2

$T_A = 25^\circ\text{C}$ , unless otherwise noted.

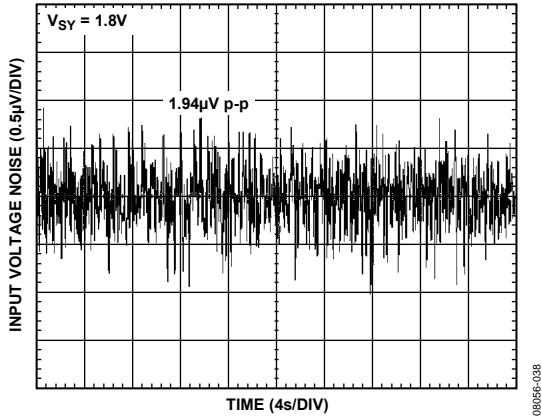

Figure 38. Input Voltage Noise 0.1 Hz to 10 Hz

08056-038

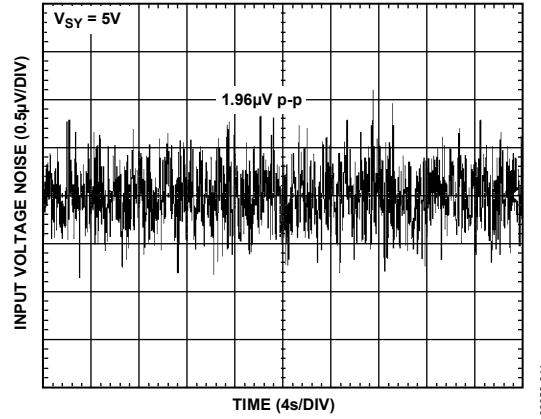

Figure 41. Input Voltage Noise 0.1 Hz to 10 Hz

08056-041

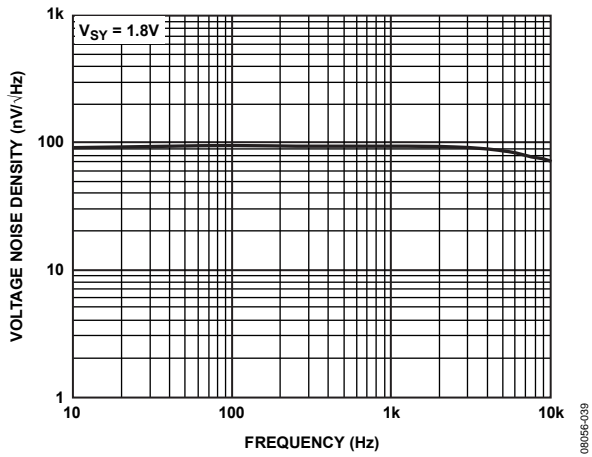

Figure 39. Voltage Noise Density vs. Frequency

08056-039

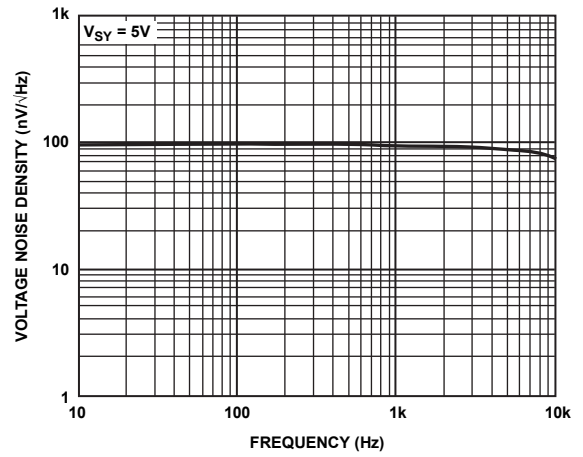

Figure 42. Voltage Noise Density vs. Frequency

08056-042

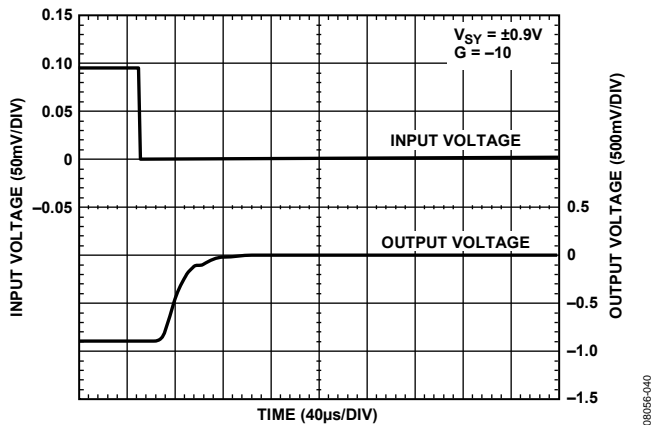

Figure 40. Positive Overload Recovery

08056-040

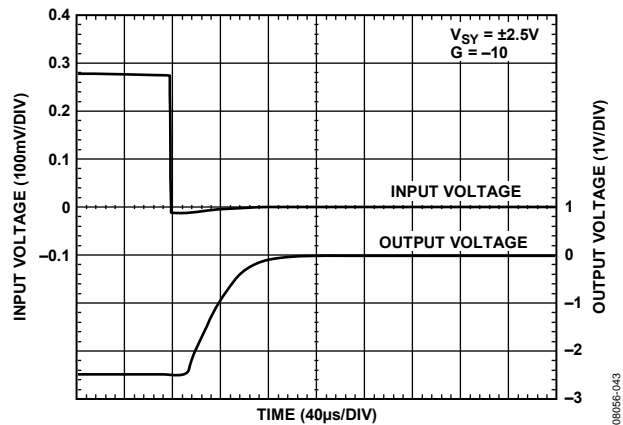

Figure 43. Positive Overload Recovery

08056-043

$T_A = 25^\circ\text{C}$ , unless otherwise noted.

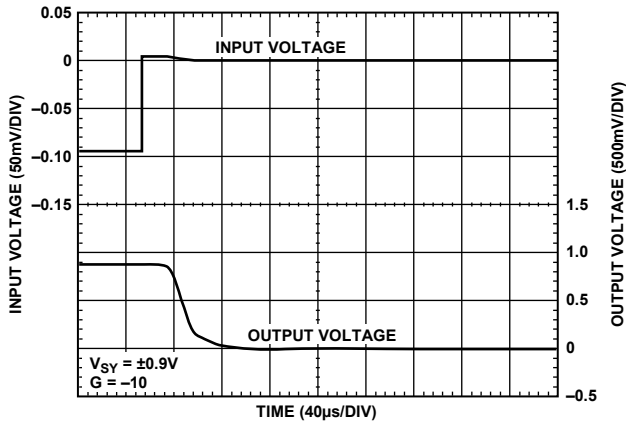

Figure 44. Negative Overload Recovery

08056-044

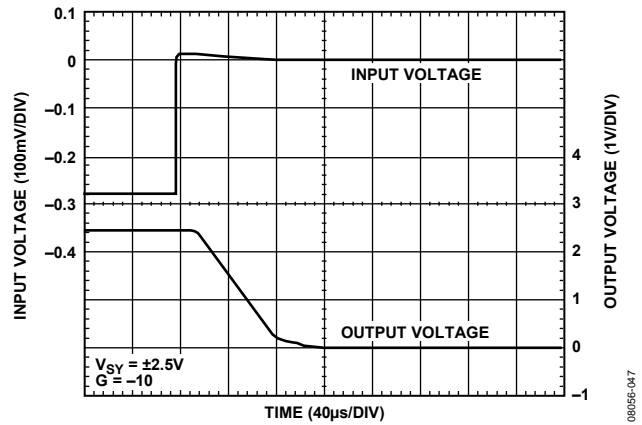

Figure 47. Negative Overload Recovery

08056-047

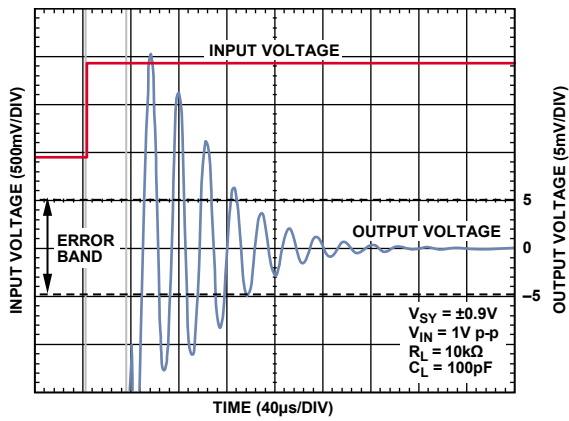

Figure 45. Positive Settling Time to 0.1%

08056-045

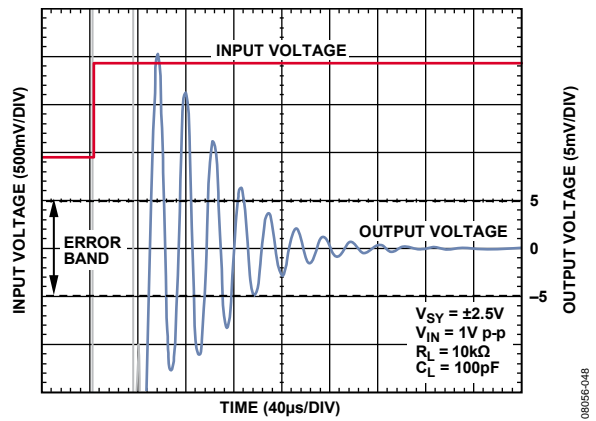

Figure 48. Positive Settling Time to 0.1%

08056-048

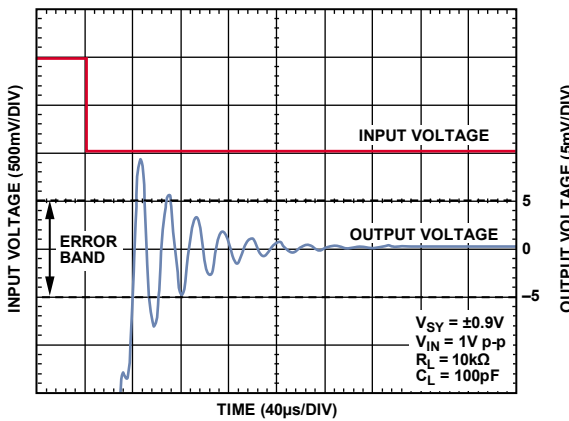

Figure 46. Negative Settling Time to 0.1%

08056-046

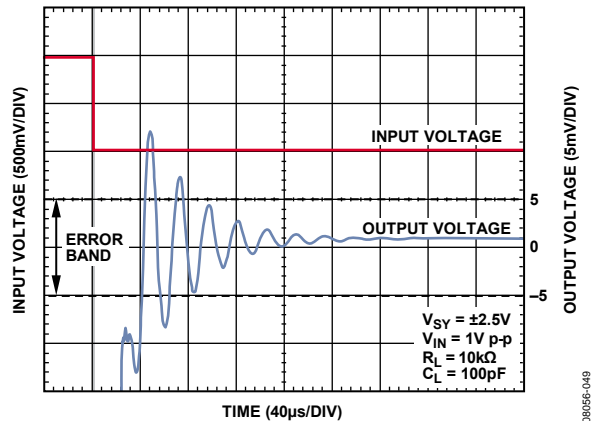

Figure 49. Negative Settling Time to 0.1%

08056-049

# ADA4051-2

$T_A = 25^\circ\text{C}$ , unless otherwise noted.

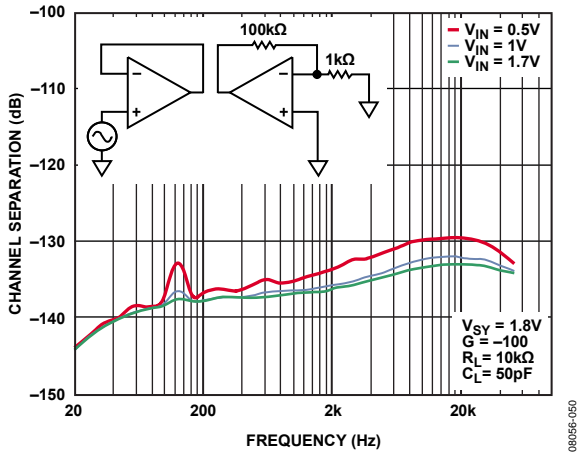

Figure 50. Channel Separation vs. Frequency

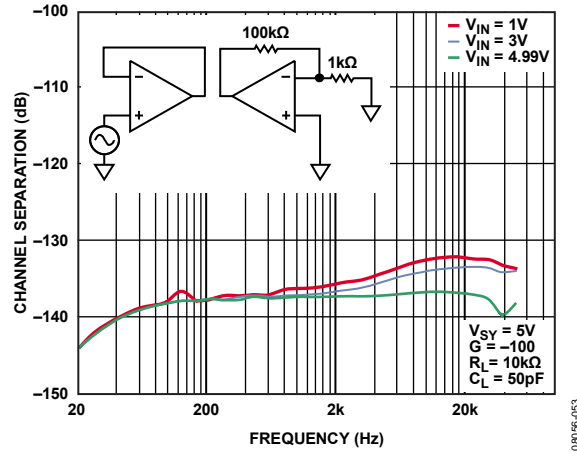

Figure 53. Channel Separation vs. Frequency

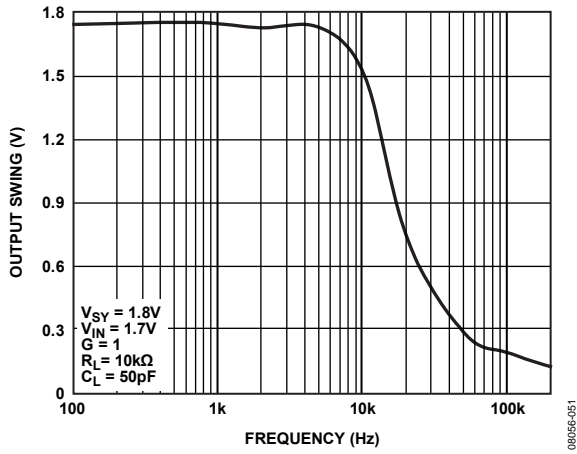

Figure 51. Output Swing vs. Frequency

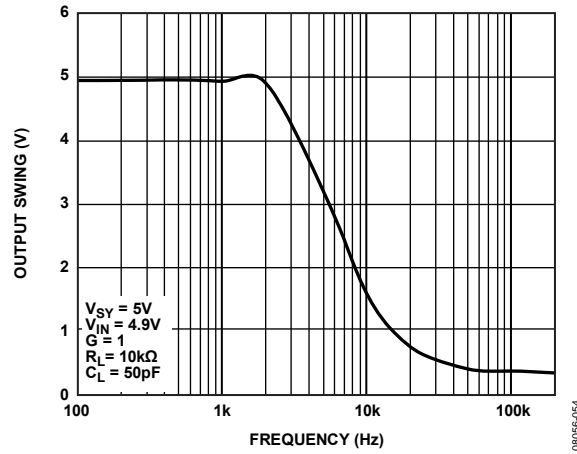

Figure 54. Output Swing vs. Frequency

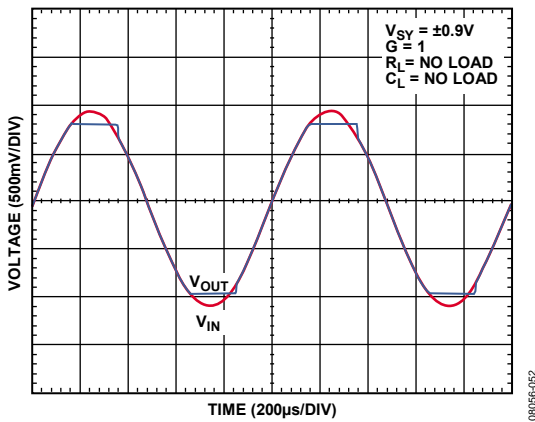

Figure 52. No Phase Reversal

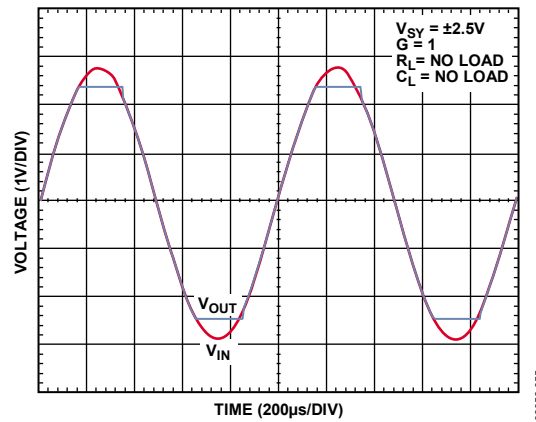

Figure 55. No Phase Reversal

## THEORY OF OPERATION

The ADA4051-2 micropower chopper operational amplifier features a novel patent-pending technique that suppresses offset-related ripple in a chopper amplifier. It nulls out the amplifier's initial offset in the dc domain that otherwise becomes a ripple at the overall output, instead of filtering the ripple in the ac domain.

Auto-zeroing and chopping are widely used for a high precision CMOS amplifier to achieve low offset, low offset drift, and no  $1/f$  noise. Auto-zeroing and chopping both have pros and cons. Auto-zeroing gets more in-band noise due to aliasing introduced by sampling. Chopping has offset-related ripple, because it modulates the initial offset associated with the amplifier up to its chopping frequency.

To accomplish the best noise vs. power trade-off, the chopping technique is the right approach to design a low offset amplifier. It is preferable to suppress the offset-related ripple in a chopper amplifier in the amplifier itself, which otherwise must be eliminated by an extra off-chip post filter.

Figure 56 shows the block diagram design of the ADA4051-2 chopper amplifier, employing a local feedback loop called auto correction feedback (ACFB). The main signal path contains an input chopping switch network (CHOP1), a first transconductance amplifier (Gm1), an output chopping switch network (CHOP2), a second transconductance amplifier (Gm2), and a third transconductance amplifier (Gm3). CHOP1 and CHOP2 operate at 40 kHz of chopping frequency to modulate the initial offset and  $1/f$  noise from Gm1 up to the chopping frequency. A fourth transconductance amplifier (Gm4) in the ACFB senses the modulated ripple at the output of CHOP2, caused by the initial offset voltage of Gm1. Then, the ripple is demodulated down to a dc domain through a third chopping switch network (CHOP3), operating with the same chopping clock as CHOP1 and CHOP2. Finally, a null transconductance amplifier (Gm5) tries to null out any dc component at the output of Gm1, which would otherwise appear in the overall output as ripple.

A switched capacitor notch filter (NF) functions to selectively suppress the undesired offset-related ripple, without disturbing the desired input signal from the overall input. The desired input dc signal appears as a dc signal at CHOP2's output. Then, it is modulated up to the chopping frequency by CHOP3 and filtered out by the NF. Therefore, it does not create any feedback and does not disturb the desired input signal. The NF is synchronized with the chopping clock to perfectly filter out the modulated component. In the same manner, the offset of Gm5 is filtered out by the combination of CHOP3 and the NF, enabling accurate ripple sensing at the output of CHOP2.

In parallel with the high dc gain path, a feedforward transconductance amplifier (Gm6) is added to bypass the phase shift introduced by the ACFB at the chopping frequency. The Gm6 is designed to have the same transconductance as the Gm1 to avoid the pole-zero doublets. Such design avoids any instability introduced by the ACFB in the overall feedback loop.

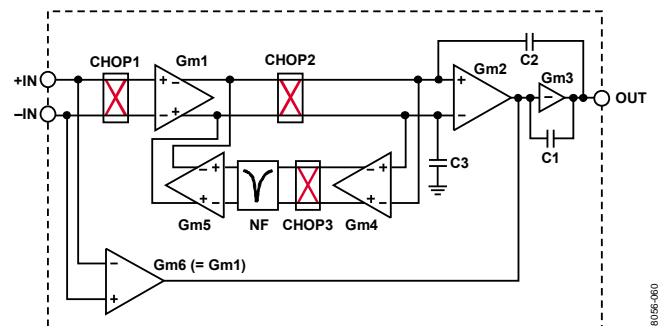

Figure 56. ADA4051-2 Chopper Amplifier Block Diagram

08035-000

## ADA4051-2

The voltage noise density is essentially flat from dc to the chopping frequency, whose level is just the thermal noise floor dominated by the  $G_{m1}$ , without receiving any addition due to the ACFB. Although the ACFB suppresses the ripple related to the chopping, there is a remaining voltage ripple. To further suppress the remaining ripple down to a desired level, it is recommended to have a post filter at the output of the amplifier.

The remaining voltage ripple is composed of two ingredients. The first ripple's ingredient is due to the residual ripple associated with the initial offset of the  $G_{m1}$ . It is proportional to the magnitude of the initial offset and creates a spectrum at the chopping frequency ( $f_{CHOP}$ ). When the amplifier is configured as a unity gain buffer, this ripple has a typical value of  $4.9 \mu\text{V rms}$  and a maximum of  $34.7 \mu\text{V rms}$ . The second ripple's ingredient is due to the intermodulation between the high frequency input signal and the chopping frequency. It depends on the input frequency ( $f_{IN}$ ) and creates a spectrum at frequencies equal to the difference between the chopping frequency and the input frequency ( $f_{CHOP} - f_{IN}$ ) and at their summation ( $f_{CHOP} + f_{IN}$ ). The magnitude of the ripple for different input frequencies is shown in Figure 57.

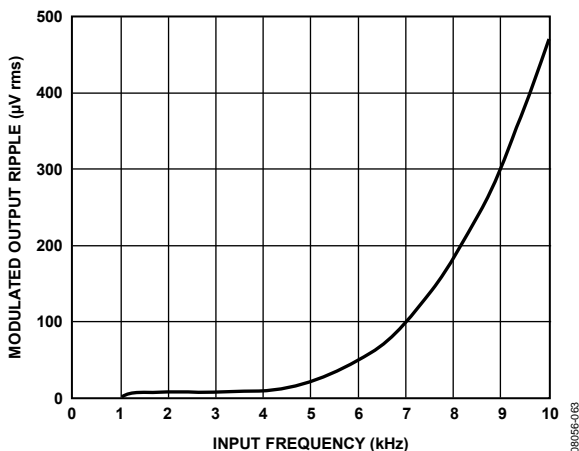

Figure 57. ADA4051-2 Modulated Output Ripple vs. Input Frequency

The design architecture of the ADA4051-2 specifically targets precision signal conditioning applications requiring accurate and stable performance from dc to 10 Hz bandwidth. In summary, the main features of the ADA4051-2 chopper amplifier are

- Considerable suppression of the offset-related ripple
- No affect on the desired input signal as long as its frequency is much lower than the chopping frequency shown in Figure 57
- Achievement of low offset similar to a conventional chopper amplifier
- No introduction of excess noise

The ADA4051-2 chopper amplifier provides rail-to-rail input range with 1.8 V to 5.5 V supply voltage range and  $20 \mu\text{A}$  supply current consumption over the  $-40^\circ\text{C}$  to  $+125^\circ\text{C}$  extended industrial temperature range. The gain bandwidth is 125 kHz as a unity gain stable amplifier up to  $100 \text{ pF}$  load capacitance.

### INPUT VOLTAGE RANGE

The ADA4051-2 has internal ESD protection diodes. These diodes are connected between the inputs and each supply rail to protect the input MOSFETs against an electrical discharge event and are normally reversed-biased. This protection scheme allows voltages as high as approximately  $0.3 \text{ V}$  beyond the supplies ( $\pm V_{SY} \pm 0.3 \text{ V}$ ) to be applied at the input of either terminal without causing permanent damage.

If either input exceeds either supply rail by more than  $0.3 \text{ V}$ , these ESD diodes become forward-biased and large amounts of current begin to flow through them. Without current limiting, this excessive current causes permanent damage to the device. If the inputs are expected to be subject to overvoltage conditions, install a resistor in series with each input to limit the input current to  $10 \text{ mA}$  maximum.

The ADA4051-2 also has internal circuitry that protects the input stage from high differential voltages. This circuitry is composed of internal  $1.33 \text{ k}\Omega$  resistors in series with each input and back-to-back diode-connected N-MOSFETs (with a typical  $V_T$  of  $0.7 \text{ V}$  for  $V_{CM}$  of  $0 \text{ V}$ ) after these series resistors. Under normal negative feedback operating conditions, the ADA4051-2 amplifier corrects its output to ensure the two inputs are at the same voltage. However, if the device is configured as a comparator or is under some unusual operating condition, the input voltages may be forced to different potentials, which may cause excessive current to flow through the internal diode-connected N-MOSFETs.

Although the ADA4051-2 is a rail-to-rail input amplifier, take care to ensure that the potential difference between the inputs does not exceed  $\pm V_{SY}$  to avert permanent damage to the device.



### OUTPUT PHASE REVERSAL

Output phase reversal occurs in some amplifiers when the input common-mode voltage range is exceeded. As a common-mode voltage moves outside the common-mode range, the outputs of these amplifiers can suddenly jump in the opposite direction to the supply rail. This usually occurs when one of the internal stages of the amplifier no longer has sufficient bias voltage across it and subsequently turns off.

The ADA4051-2 amplifier has been carefully designed to prevent any output phase reversal, provided both inputs are maintained approximately within 0.3 V above and below the supply voltages ( $\pm V_{SY} \pm 0.3$  V). If one or both inputs exceed the input voltage range but remain within the  $\pm V_{SY} \pm 0.3$  V range, an internal loop opens and the output remains in saturation mode, without phase reversal, until the input voltage is brought back to within the input voltage range limits as is shown in Figure 52 and Figure 55.

# ADA4051-2

## OUTLINE DIMENSIONS

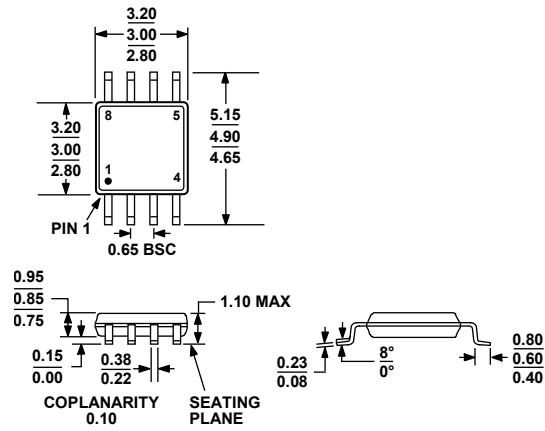

COMPLIANT TO JEDEC STANDARDS MO-187-AA

Figure 58. 8-Lead Mini Small Outline Package [MSOP] (RM-8)

Dimensions shown in millimeters

## ORDERING GUIDE

Model	Temperature Range	Package Description	Package Option	Branding
ADA4051-2ARMZ <sup>1</sup>	-40°C to +125°C	8-Lead MSOP	RM-8	A2M
ADA4051-2ARMZ-R7 <sup>1</sup>	-40°C to +125°C	8-Lead MSOP	RM-8	A2M
ADA4051-2ARMZ-RL <sup>1</sup>	-40°C to +125°C	8-Lead MSOP	RM-8	A2M

<sup>1</sup> Z = RoHS Compliant Part.

**NOTES**

**NOTES**