

## Voltage Variable Absorptive Attenuator 40 dB, 0.5 - 3.0 GHz

Rev. V2

### Features

- Single Positive Voltage Control: 0 to +5 Volts
- 40 dB Attenuation Range at 900 MHz
- $\pm 2$  dB Linearity from BSL
- Low DC Power Consumption
- Tape and Reel Packaging Available
- Lead-Free SOIC-8 Package
- 100% Matte Tin Plating over Copper
- Halogen-Free "Green" Mold Compound
- 260°C Reflow Compatible
- RoHS\* Compliant Version of AT-108

### Description

M/A-COM's MAAVSS0007 is a GaAs MESFET MMIC voltage variable absorptive attenuator in a lead-free SOIC-8 surface mount plastic package. The MAAVSS0007 is ideally suited for use where linear attenuation, fine tuning and very low power consumption are required.

Typical applications include radio, cellular, GPS equipment and automatic gain/level control circuits.

The MAAVSS0007 is fabricated with a monolithic GaAs MMIC using a mature 1-micron process. The process features full chip passivation for increased performance and reliability.

### Ordering Information <sup>1,2</sup>

Part Number	Package
MAAVSS0007	Bulk Packaging
MAAVSS0007TR	1000 piece reel
MAAVSS0007SMB	Sample Board

1. Reference Application Note M513 for reel size information.
2. All sample boards include 5 loose parts.

### Functional Schematic <sup>3,4,5,6</sup>

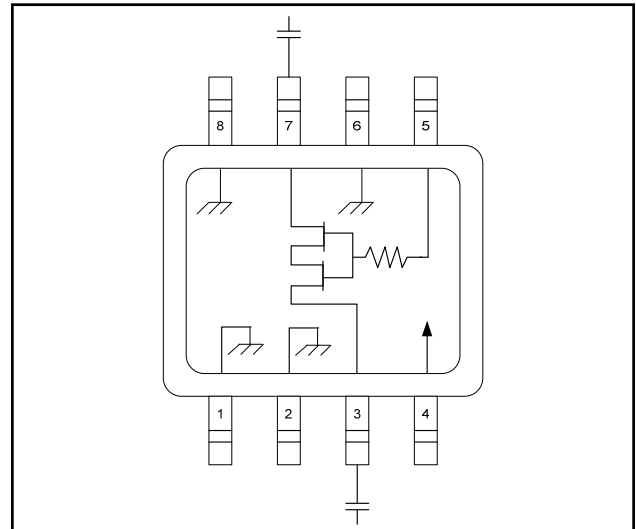

3.  $V_{CC} = +5$  VDC @ 50  $\mu$ A maximum.
4.  $V_c = 0$  VDC to +5 VDC @ 50  $\mu$ A maximum.
5. External DC blocking capacitors are requirements on all RF ports.
6. 39 pF used for data measurements.

### Pin Configuration

Pin No.	Function	Pin No.	Function
1	Ground	5	$V_c$
2	Ground	6	Ground
3	RF Port	7	RF Port
4	$V_{CC}$	8	Ground

### Absolute Maximum Ratings <sup>7,8</sup>

Parameter	Absolute Maximum
Input Power	+21 dBm
Supply Voltage $V_{CC}$	$-1 \text{ V} \leq V_{CC} \leq +8 \text{ V}$
Control Voltage $V_c$	$-1 \text{ V} \leq V_c \leq V_{CC} + 0.5 \text{ V}$
Operating Temperature	$-40^\circ\text{C}$ to $+85^\circ\text{C}$
Storage Temperature	$-65^\circ\text{C}$ to $+150^\circ\text{C}$

7. Exceeding any one or combination of these limits may cause permanent damage to this device.
8. M/A-COM does not recommend sustained operation near these survivability limits.

<sup>1</sup> \* Restrictions on Hazardous Substances, European Union Directive 2002/95/EC.

**ADVANCED:** Data Sheets contain information regarding a product M/A-COM Technology Solutions is considering for development. Performance is based on target specifications, simulated results, and/or prototype measurements. Commitment to develop is not guaranteed.  
**PRELIMINARY:** Data Sheets contain information regarding a product M/A-COM Technology Solutions has under development. Performance is based on engineering tests. Specifications are typical. Mechanical outline has been fixed. Engineering samples and/or test data may be available. Commitment to produce in volume is not guaranteed.

• **North America** Tel: 800.366.2266 / Fax: 978.366.2266  
 • **Europe** Tel: 44.1908.574.200 / Fax: 44.1908.574.300  
 • **Asia/Pacific** Tel: 81.44.844.8296 / Fax: 81.44.844.8298  
 Visit [www.macomtech.com](http://www.macomtech.com) for additional data sheets and product information.

M/A-COM Technology Solutions Inc. and its affiliates reserve the right to make changes to the product(s) or information contained herein without notice.

## Voltage Variable Absorptive Attenuator 40 dB, 0.5 - 3.0 GHz

Rev. V2

### Electrical Specifications: $T_A = 25^\circ\text{C}$ , $Z_0 = 50 \Omega$

Parameter	Test Conditions	Units	Min.	Typ.	Max.
Insertion Loss	0.5 - 1.0 GHz	dB	—	2.5	—
	1.0 - 3.0 GHz	dB	—	2.6	3.5
Attenuation	0.5 - 1.0 GHz	dB	—	43	—
	1.0 - 2.0 GHz	dB	35	40	—
	2.0 - 3.0 GHz	dB	—	33	—
Flatness (peak-to-peak)	0.5 - 1.0 GHz	dB	—	$\pm 0.5$	—
	1.0 - 2.0 GHz	dB	—	$\pm 1.2$	—
	2.0 - 3.0 GHz	dB	—	$\pm 1.5$	—
VSWR	0.5 - 3.0 GHz	Ratio	—	2:1	—
Trise, Tfall	10% to 90% RF, 90% to 10% RF	$\mu\text{S}$	—	15	—
Ton, Toff	50% Control to 90% RF, 50% Control to 10% RF	$\mu\text{S}$	—	25	—
Transients	In-Band	mV	—	12	—

### Lead-Free SOIC-8<sup>†</sup>

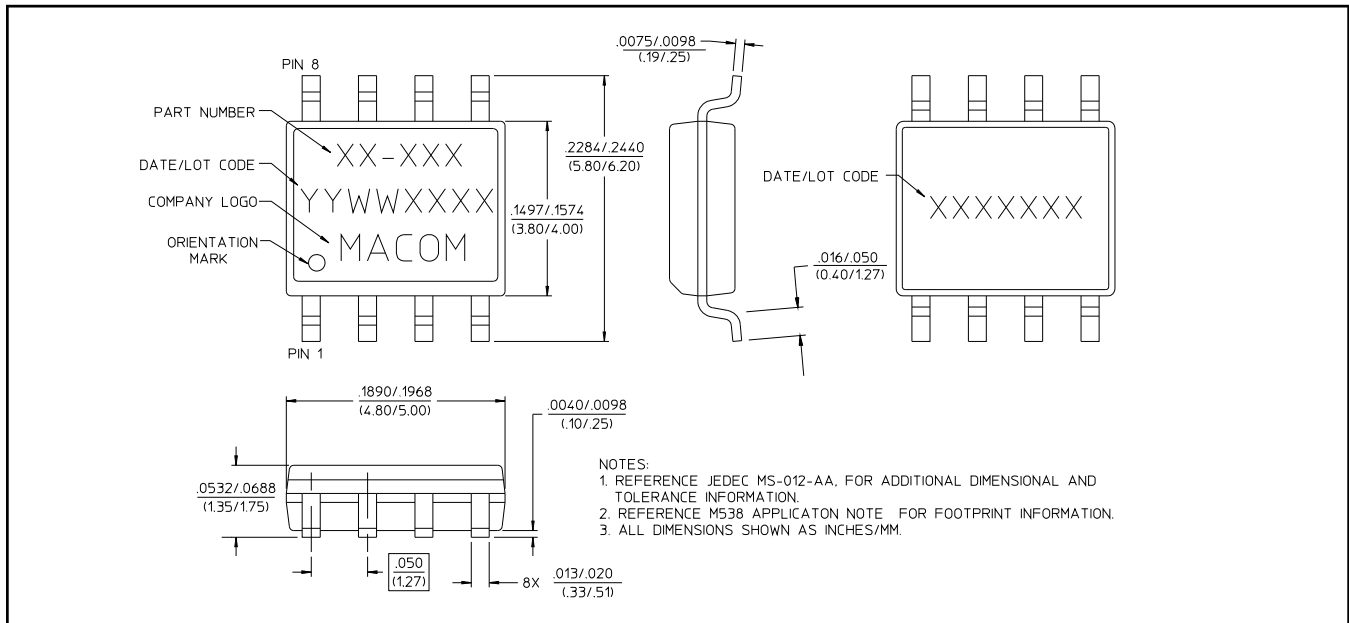

<sup>†</sup> Reference Application Note M538 for lead-free solder reflow recommendations.  
Meets JEDEC moisture sensitivity level 1 requirements.

## Voltage Variable Absorptive Attenuator 40 dB, 0.5 - 3.0 GHz

Rev. V2

### Typical Performance Curves @ 25°C

**Attenuation vs. Control Voltage**

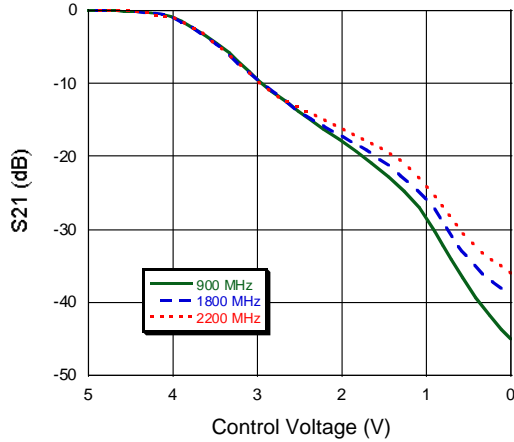

**Insertion Loss vs. Frequency**

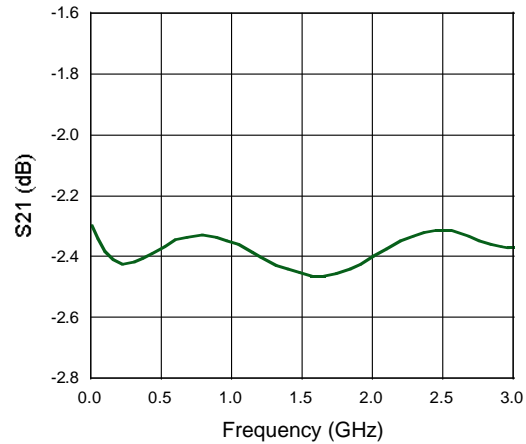

**Return Loss vs. Control Voltage, F = 900 MHz**

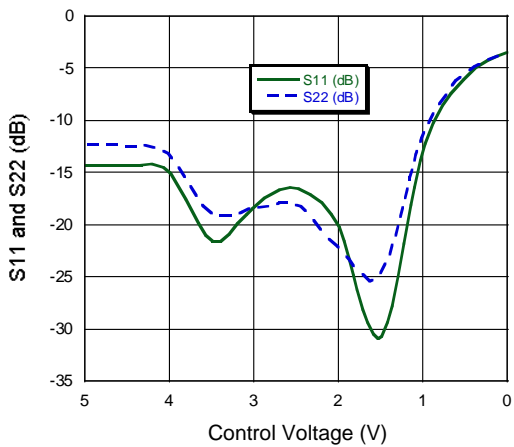

**Return Loss vs. Control Voltage, F = 1800 MHz**

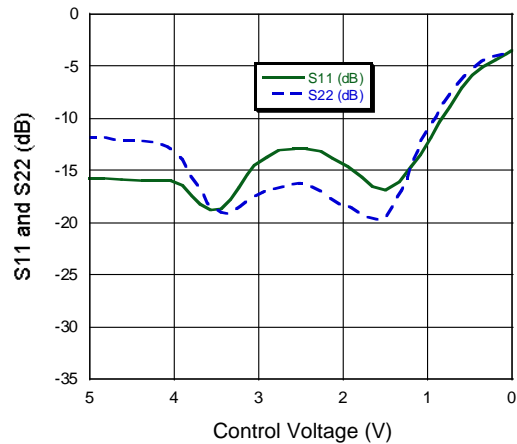

**Return Loss vs. Control Voltage, F = 2200 MHz**

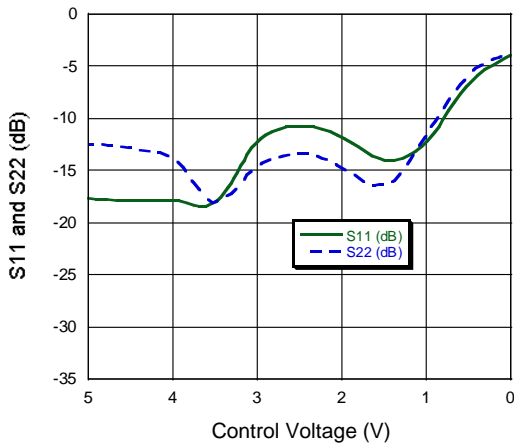

**Maximum Attenuation vs. Frequency**

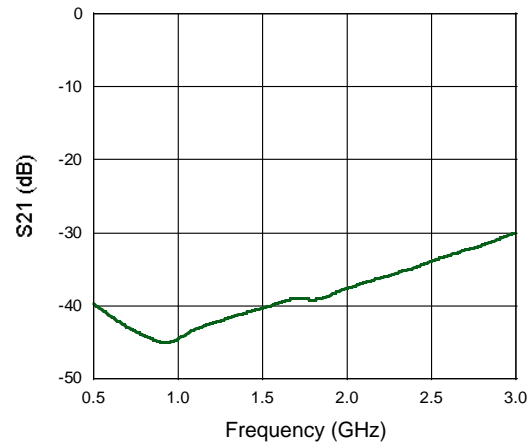

## Typical Performance Curves @ 25°C

1 dB Compression vs. Control Voltage, F = 900 MHz

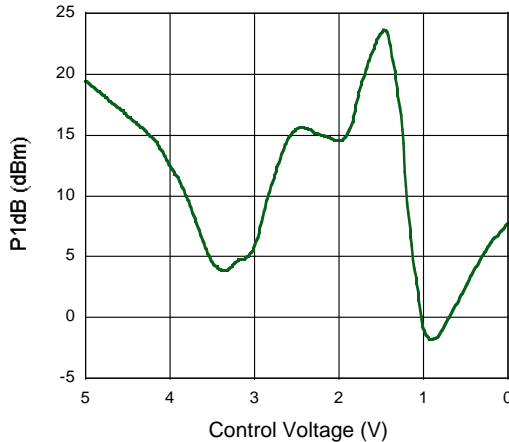

IP3 vs. Control Voltage

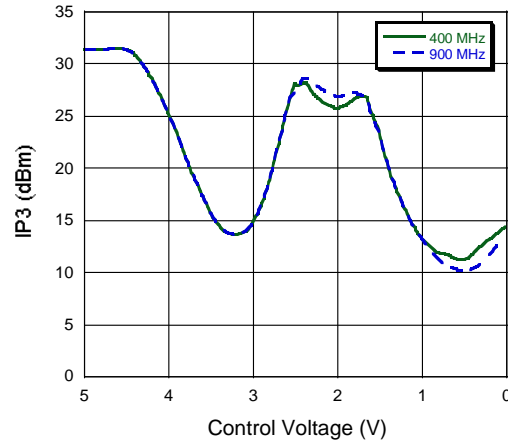

Attenuation vs. Temperature  
Normalized to 25°C, F = 900 MHz

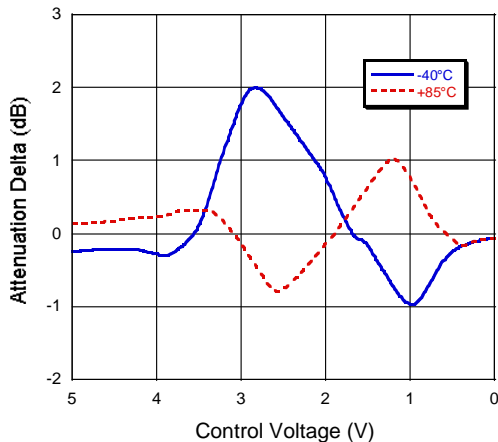

## Handling Procedures

Please observe the following precautions to avoid damage:

## Static Sensitivity

Gallium Arsenide Integrated Circuits are sensitive to electrostatic discharge (ESD) and can be damaged by static electricity. Proper ESD control techniques should be used when handling these devices.