

25 Amp, No Heatsink, Isolated DC/DC Converter

The PQ24018QGA25 PowerQor™ Giga quarter-brick converter is a next-generation, board-mountable, isolated, fixed switching frequency dc/dc converter that uses synchronous rectification to achieve extremely high conversion efficiency. The power dissipated by the converter is so low that a heatsink is not required, which saves cost, weight, height, and application effort. All of the power and control components are mounted to the multi-layer PCB substrate with high-yield surface mount technology. Since the PowerQor converter has no explicit thermal connections, it is extremely reliable.

PowerQor
Giga



PQ24018QGA25 Module

Operational Features

- High efficiency, >84% at full rated load current
- Delivers up to 25 amps of output current with minimal derating - no heatsink required
- Wide input voltage range: 18V – 36V meets or exceeds all 24V bus standards
- Fixed frequency switching provides predictable EMI performance
- No minimum load requirement means no preload resistors required

Mechanical Features

- Industry standard quarter-brick pin-out configuration
- Industry standard size: 1.45" x 2.3"
- Total height less than 0.40", permits better airflow and smaller card pitch
- Total weight: 34 grams (1.2 oz.), lower mass greatly reduces vibration and shock problems

Control Features

- On/Off control referenced to input side (positive and negative logic options are available)
- Remote sense for the output voltage compensates for output distribution drops
- Output voltage trim permits custom voltages and voltage margining

Protection Features

- Input under-voltage lockout disables converter at low input voltage conditions
- Output current limit and short circuit protection protects converter from excessive load current or short circuits
- Output over-voltage protection protects load from damaging voltages
- Thermal shutdown protects converter from abnormal environmental conditions

Safety Features

- 2000V, 10 MΩ input-to-output isolation provides input/output ground separation
- UL 1950 recognized (US & Canada), basic insulation rating (pending)
- TUV certification to EN60950 (pending)
- Meets 72/23/EEC and 93/68/EEC directives which facilitates CE Marking in user's end product
- Board and plastic components meet 94V-0 flammability requirements
- NEBS and ETSI compliant

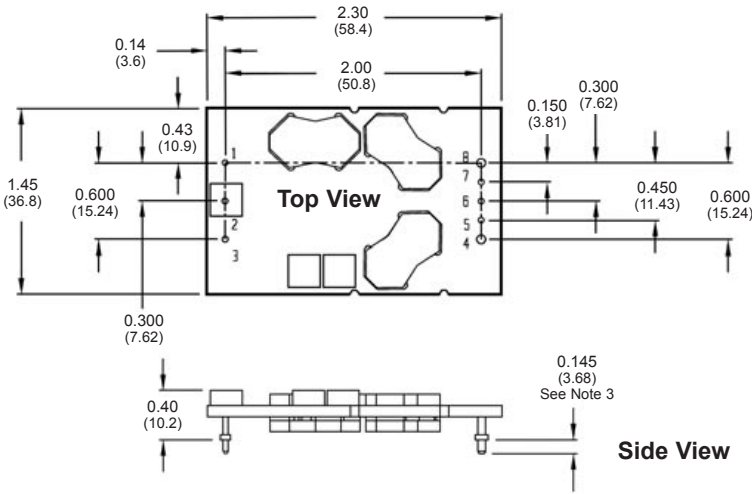

Shown Actual Size

- 1) Pins 1-3, 5-7 are 0.040" (1.02mm) dia. with 0.080" (2.03mm) dia. standoff shoulders.
- 2) Pins 4 and 8 are 0.062" (1.57 mm) dia. with 0.100" (2.54mm) dia. standoff shoulders.
- 3) Other pin extension lengths available.
- 4) Undimensioned components are for visual reference only.
- 5) Weight: 1.2 oz. (34g) typical
- 6) All dimensions in inches (mm)
Tolerances: x.xx +/-0.02 in. (x.x +/-0.5mm)
x.xxx +/-0.010 in. (x.xx +/-0.25mm)
- 7) Workmanship: Meets or exceeds IPC-A-610B Class II

Pin No.	Name	Function
1	Vin(+)	Positive input voltage (18 - 36V)
2	ON/OFF	TTL input to turn converter on and off, referenced to Vin(-), with internal pull up.
3	Vin(-)	Negative input voltage
4	Vout(-)	Negative output voltage
5	SENSE(-)	Negative remote sense ¹
6	TRIM	Output voltage trim ²
7	SENSE(+)	Positive remote sense ³
8	Vout(+)	Positive output voltage

ABSOLUTE MAXIMUM RATINGS

Input Voltage:

Non-Operating: 72V continuous

Operating: 60V continuous

Input/Output Isolation Voltage: 2000V

Storage Temperature: -55°C to +125°C

Operating Temperature: -40°C to +115°C

Voltage at ON/OFF input pin: +18V / -2V

Notes:

1. Pin 5 should be connected to Vout(-) at load.
2. Leave Pin 6 open for nominal output voltage.
3. Pin 7 should be connected to Vout(+) at load.

OPTIONS

- **Logic sense** - Negative (N); converter is on when the ON/OFF signal is low. Positive (P); converter is on when the ON/OFF signal is high. Logic input is TTL compatible with an internal pull up. Use N or P as 13th letter in part number to indicate logic.
- **Pin Length** - a variety of pin lengths are available for all modules (see last page). The 14th letter in the part number indicates pin length.
- **Feature Set** - Quarter-bricks are available with Standard (S) feature options only. Use S as 15th letter in part number to indicate feature set.

SAFETY

- **UL 1950** - All modules are UL 1950 recognized (US & Canada) with basic insulation rating.
- **EN60950** - All modules are TUV certified to EN60950 requirements.
- **72/23/EEC** - All modules meet 72/23/EEC directives.
- **93/68/EEC** - All modules meet 93/68/EEC directives.
- **94V-0** - All modules meet 94V-0 flammability requirements for board and plastic components.
- **NEBS** - All modules meet NEBS compatibility.
- An external input fuse must always be used to meet these safety requirements.



Technical Specification

**Quarter
Brick**

24V_{in} 1.8V_{out} 25A

PQ24018QGA25 ELECTRICAL CHARACTERISTICS

T_A=25°C, airflow rate=300 LFM, V_{in}=24Vdc, nominal V_{out} unless otherwise noted; full operating temperature range is -40°C to +115°C ambient temperature with appropriate power derating. Specifications subject to change without notice.

PARAMETER	NOTES and CONDITIONS	PQ24018QGA25			
		Min.	Typ.	Max.	Units
INPUT CHARACTERISTICS					
Operating Input Voltage Range		18	24	36	V
Input Under-Voltage Lockout					
Turn-On Voltage Threshold		15.5	16.0	16.5	V
Turn-Off Voltage Threshold		14.0	14.5	15.0	V
Lockout Hysteresis Voltage		1.0	1.5	2.0	V
Maximum Input Current	100% Load, 18V _{in}			3.0	A
No-Load Input Current			60	100	mA
Off Converter Input Current			1.6	3	mA
Input Reflected-Ripple Current	P-P thru 3.3µH inductor; Figures 13 & 15		6		mA
OUTPUT CHARACTERISTICS					
Output Voltage Set Point		1.782	1.800	1.816	V
Output Voltage Regulation					
Over Line			±0.1 (2)	±0.3 (5)	% (mV)
Over Load			±0.1 (2)	±0.3 (5)	% (mV)
Over Temperature			±9	±27	mV
Total Output Voltage Range	over sample line, load and temperature	1.75		1.85	V
Output Voltage Ripple and Noise	20MHz bandwidth; Figures 13 & 16				
Peak-to-Peak	Full Load, 1µF ceramic, 10µF tantalum		25	50	mV
RMS	Full Load, 1µF ceramic, 10µF tantalum		6	12	mV
Operating Output Current Range		0		25	A
Output DC Current-Limit Inception	Output Voltage 10% Low; Fig. 17 & 18	26	30	34	A
Short-Circuit Protection (redundant shutdown)		52	56	60	A
DYNAMIC CHARACTERISTICS					
Input Voltage Ripple Rejection	120 Hz; Figure 20		TBD		dB
Output Voltage Current Transient	470µF load cap, 5A/µs; Figure 12				
Positive Step Change in Output Current	50% lo to 75% lo		190		mV
Negative Step Change in Output Current	75% lo to 50% lo		190		mV
Settling Time to within 1% V _{out} nominal			700		µs
Turn-On Transient					
Turn-On Time	Full load, V _{out} =90% nom.; Figs 9 & 10	1	4	8	ms
Start-Up Inhibit Period	-40°C to +125°C; Figure F	180	200	215	ms
Maximum Output Capacitance	Full load; 5% overshoot of V _{out} at startup			35,000	µF
EFFICIENCY					
100% Load	Figure 1		84		%
50% Load			87		%
TEMPERATURE LIMITS FOR POWER DERATING CURVES					
Semiconductor Junction Temperature	Plastic Package rated to 150°C			125	°C
Board Temperature	Board rated to 165°C			125	°C
Transformer Temperature	Figures 5 - 8			125	°C
ISOLATION CHARACTERISTICS					
Isolation Voltage		2000			V
Isolation Resistance		10			MΩ
Isolation Capacitance			470		pF
FEATURE CHARACTERISTICS					
Switching Frequency		220	240	260	kHz
ON/OFF Control (Option P)					
Off-State Voltage		-2		0.8	V
On-State Voltage		2.4		18	V
ON/OFF Control (Option N)					
Off-State Voltage		2.4		18	V
On-State Voltage		-2		0.8	V
ON/OFF Control (Either Option)					
Pull-Up Voltage	See circuit diagram; Figure B		V _{in} /3	9.6	V
Pull-Up Resistance	Pull up to V _{in} /3		33		kΩ
Output Voltage Trim Range	Across Pins 8 & 4; Figures C & D	-20		+10	%
Output Over-Voltage Protection	Over full temp range; % of nominal V _{out}	117	122	127	%
Over-Temperature Shutdown	Average PCB Temperature		125		°C

Patents: SynQor is protected under various patents, including but not limited to U.S. Patent # 5,999,417.

Performance Curves

Quarter Brick **24V_{in} 1.8V_{out} 25A**

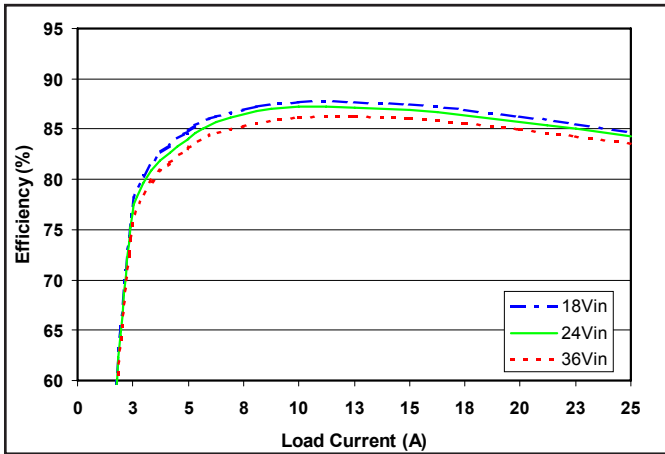

Figure 1: Efficiency at nominal output voltage vs. load current for minimum, nominal, and maximum input voltage at 25°C.

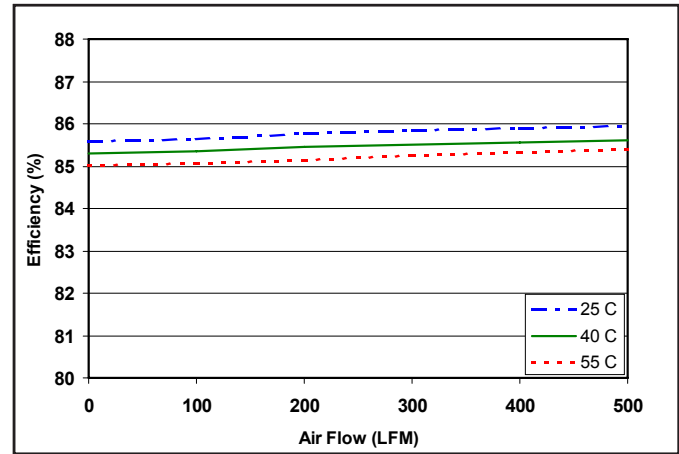

Figure 2: Efficiency at nominal output voltage and 60% rated power vs. airflow rate for ambient air temperatures of 25°C, 40°C, and 55°C (nominal input voltage).

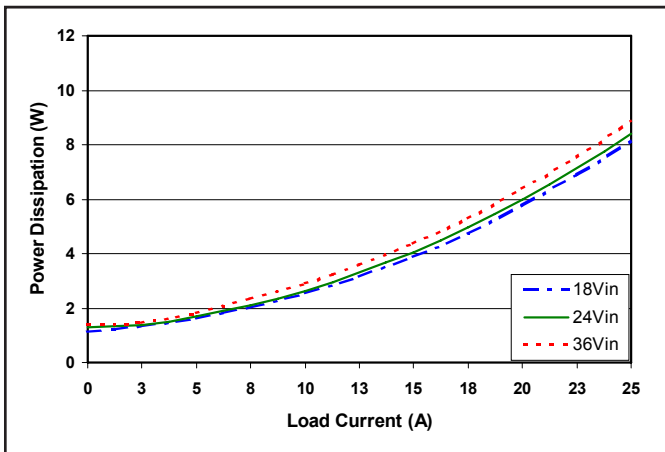

Figure 3: Power dissipation at nominal output voltage vs. load current for minimum, nominal, and maximum input voltage at 25°C.

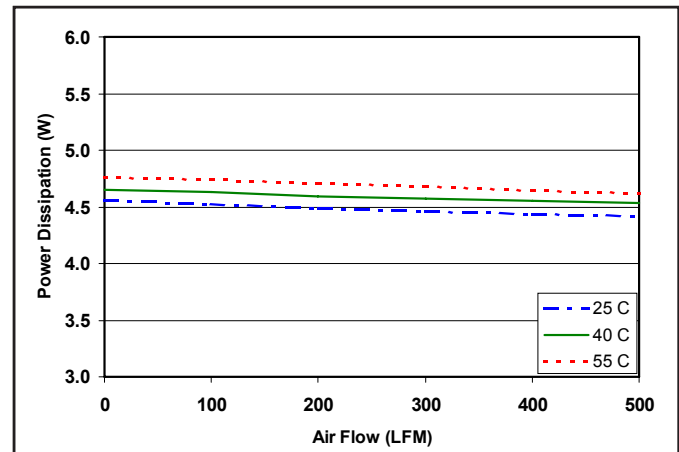

Figure 4: Power dissipation at nominal output voltage and 60% rated power vs. airflow rate for ambient air temperatures of 25°C, 40°C, and 55°C (nominal input voltage).

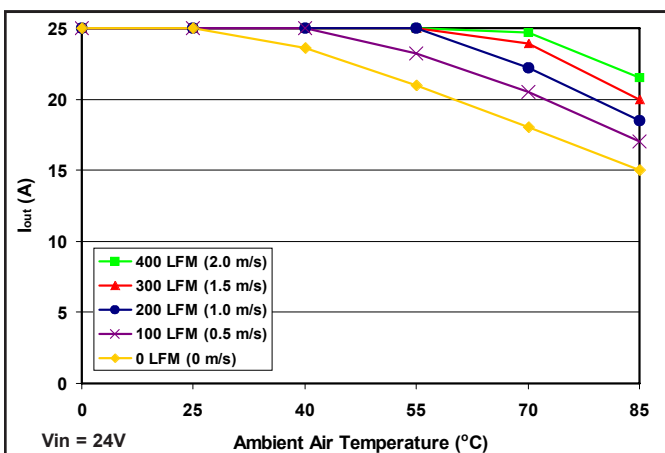

Figure 5: Maximum output power derating curves vs. ambient air temperature for airflow rates of 0 LFM through 400 LFM with air flowing across the converter from pin 1 to pin 3 (nominal input voltage).

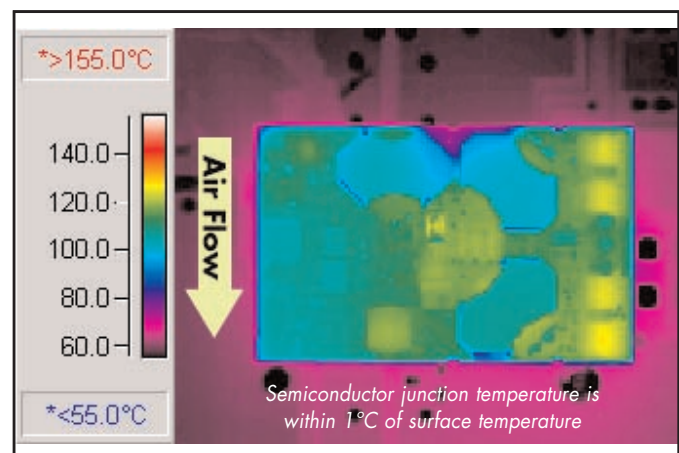

Figure 6: Thermal plot of converter at 25 amp load current with 55°C air flowing at the rate of 200 LFM. Air is flowing across the converter sideways from pin 1 to pin 3 (nominal input voltage).

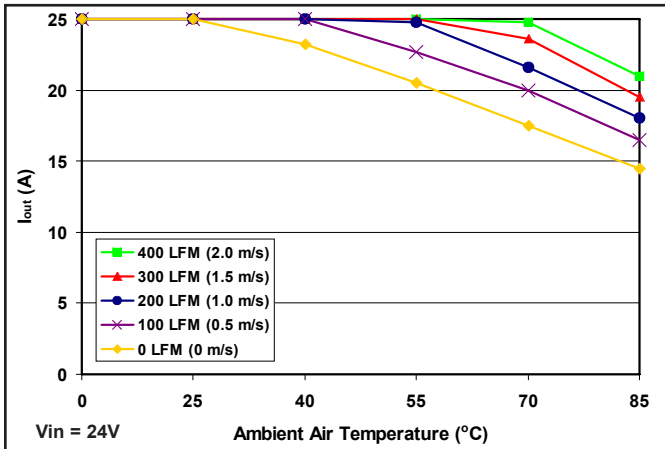

Figure 7: Maximum output power derating curves vs. ambient air temperature for airflow rates of 0 LFM through 400 LFM with air flowing lengthwise from output to input (nominal input voltage).

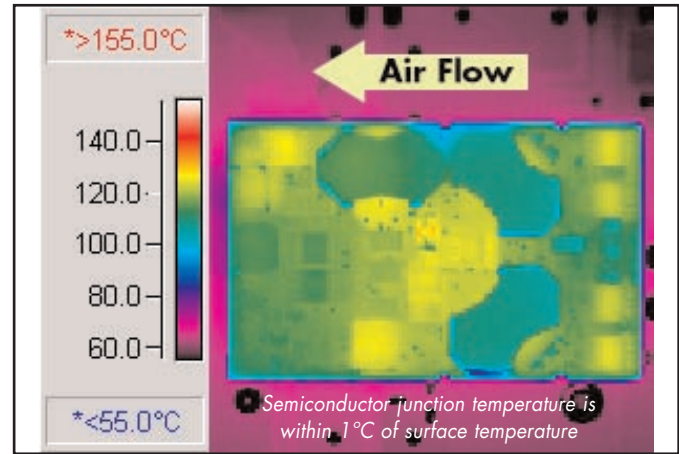

Figure 8: Thermal plot of converter at 25 amp load current with 55°C air flowing at the rate of 200 LFM. Air is flowing across the converter from output to input (nominal input voltage).

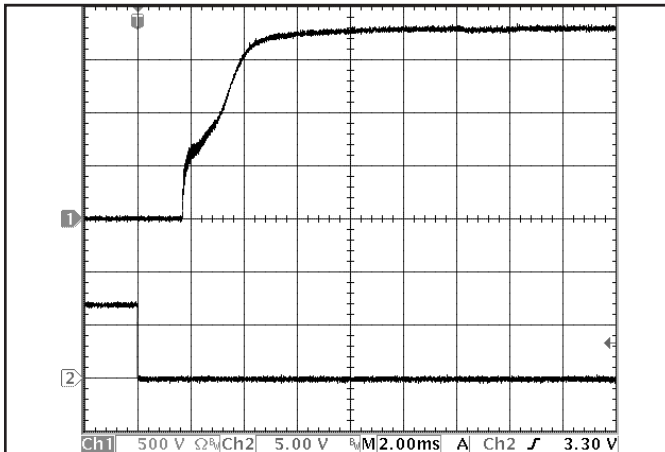

Figure 9: Turn-on transient at full load (resistive load) (2 ms/div).
Ch1: V_{out} (500mV/div)
Ch2: ON/OFF input (5V/div)

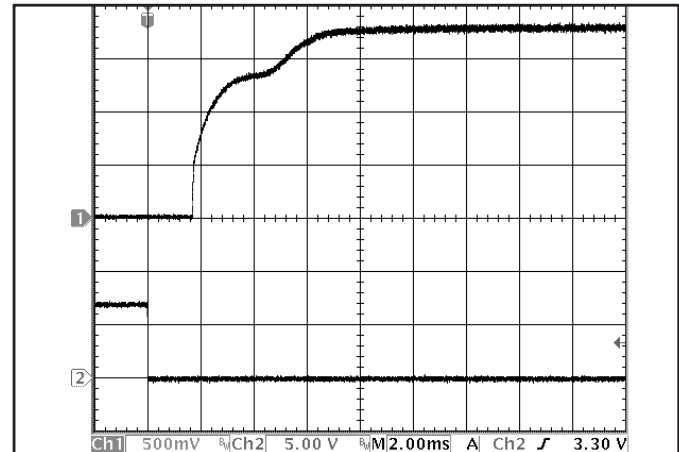

Figure 10: Turn-on transient at zero load (2 ms/div).
Ch1: V_{out} (500mV/div)
Ch2: ON/OFF input (5V/div)

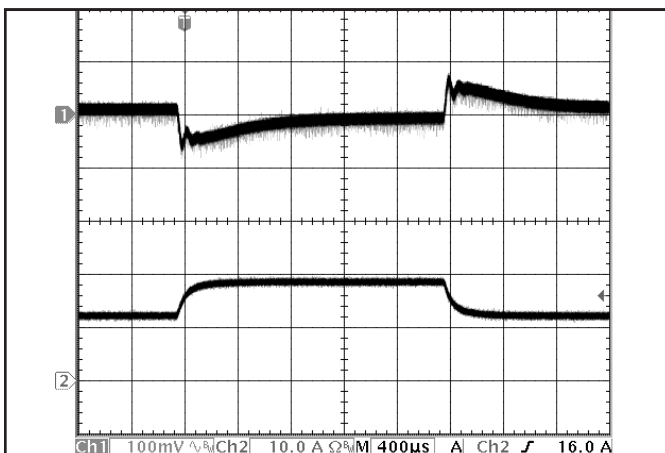

Figure 11: Output voltage response to step-change in load current (50%-75%-50% of I_{out}(max); dI/dt = 0.1A/μs). Load cap: 10μF, 100 mΩ ESR tantalum capacitor and 1μF ceramic capacitor. Ch1: V_{out} (100mV/div), Ch2: I_{out} (10A/div).

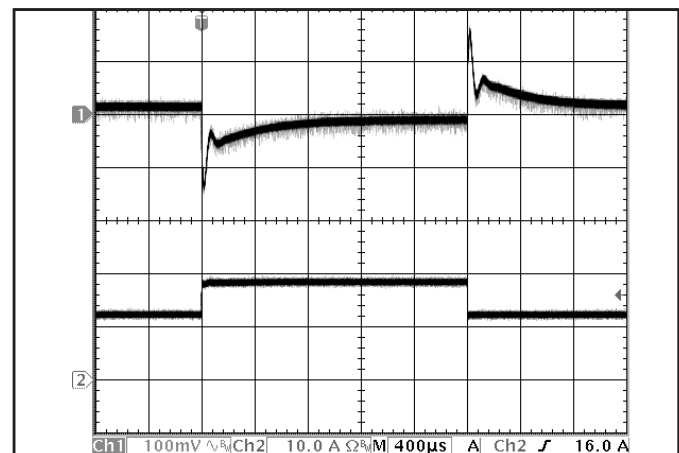

Figure 12: Output voltage response to step-change in load current (50%-75%-50% of I_{out}(max); dI/dt = 5A/μs). Load cap: 470μF, 30 mΩ ESR tantalum capacitor and 1μF ceramic capacitor. Ch1: V_{out} (100mV/div), Ch2: I_{out} (10A/div).

Performance Curves

Quarter Brick **24V_{in} 1.8V_{out} 25A**

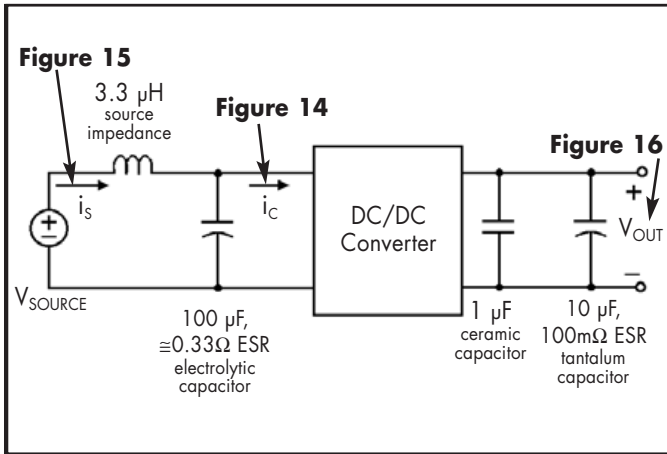

Figure 13: Test set-up diagram showing measurement points for Input Terminal Ripple Current (Figure 14), Input Reflected Ripple Current (Figure 15) and Output Voltage Ripple (Figure 16).

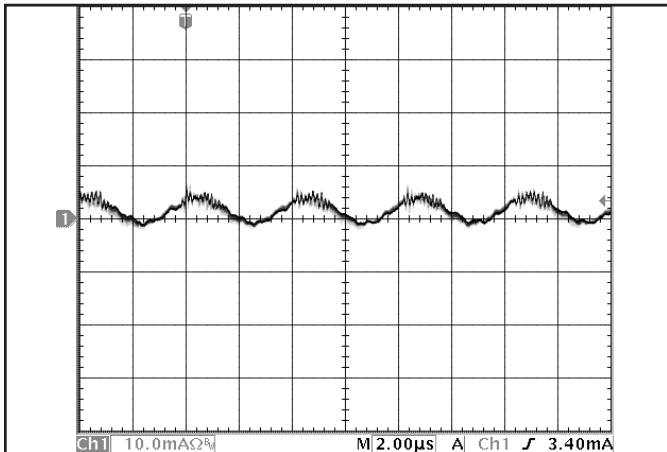

Figure 15: Input reflected ripple current, i_s , through a $3.3 \mu\text{H}$ source inductor at nominal input voltage and rated load current ($10 \text{mA}/\text{div}$). See Figure 13.

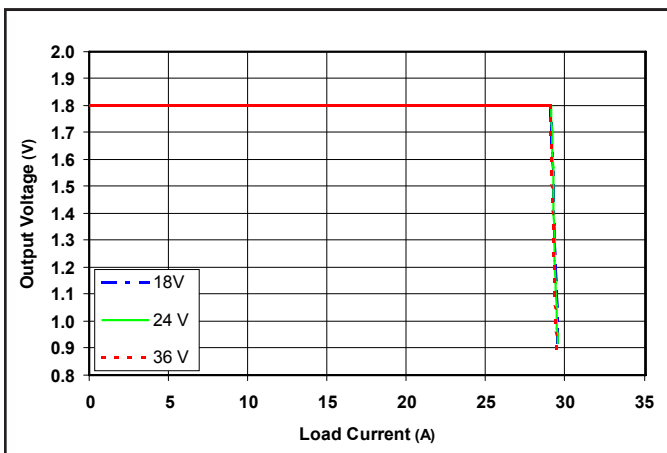

Figure 17: Output voltage vs. load current showing typical current limit curves. Below 0.9V (typical), the converter will shut off, and restart after a start-up inhibit period has elapsed. (see Figure F)

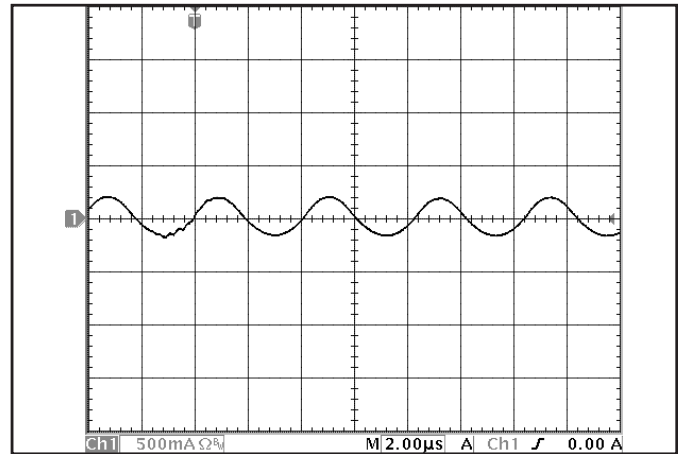

Figure 14: Input Terminal Ripple Current, i_c , at full rated output current and nominal input voltage with $3.3 \mu\text{H}$ source impedance and $100 \mu\text{F}$ electrolytic capacitor ($500 \text{mA}/\text{div}$). See Figure 13.

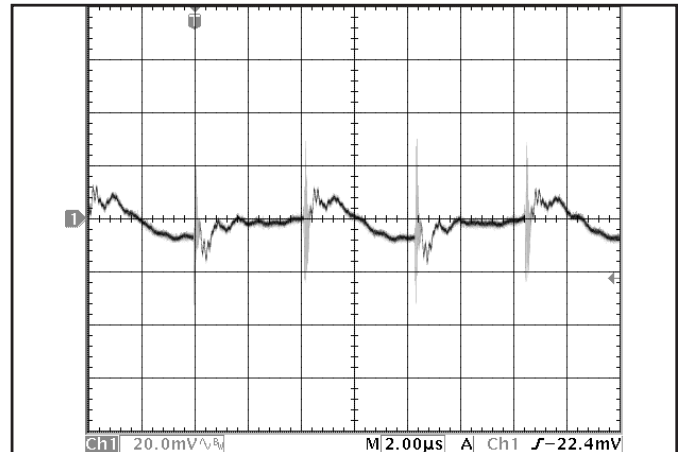

Figure 16: Output voltage ripple at nominal input voltage and rated load current ($20 \text{mV}/\text{div}$). Load capacitance: $1 \mu\text{F}$ ceramic capacitor and $10 \mu\text{F}$ tantalum capacitor. Bandwidth: 20MHz . See Figure 13.

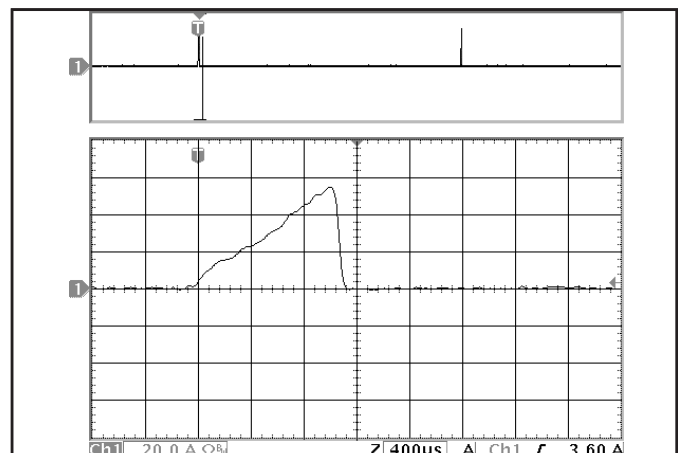

Figure 18: Load current ($20\text{A}/\text{div}$) as a function of time when the converter attempts to turn on into a $10 \text{m}\Omega$ short circuit. Top trace ($2.5\text{ms}/\text{div}$) is an expansion of the on-time portion of the bottom trace.

Performance Curves

Quarter Brick **24V_{in}** **1.8V_{out}** **25A**

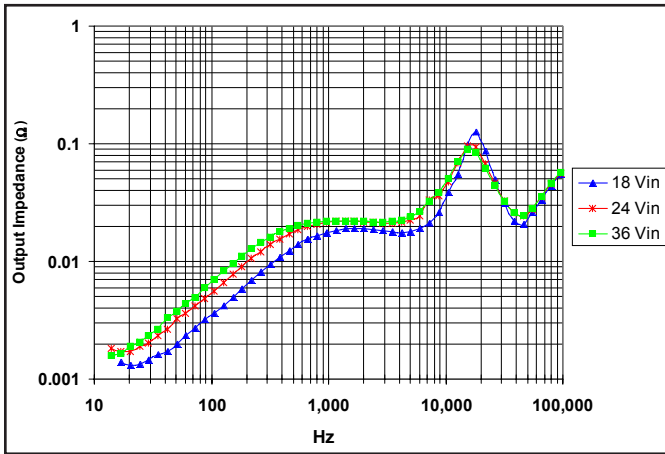

Figure 19: Magnitude of incremental output impedance ($Z_{out} = v_{out}/i_{out}$) for minimum, nominal, and maximum input voltage at full rated power.

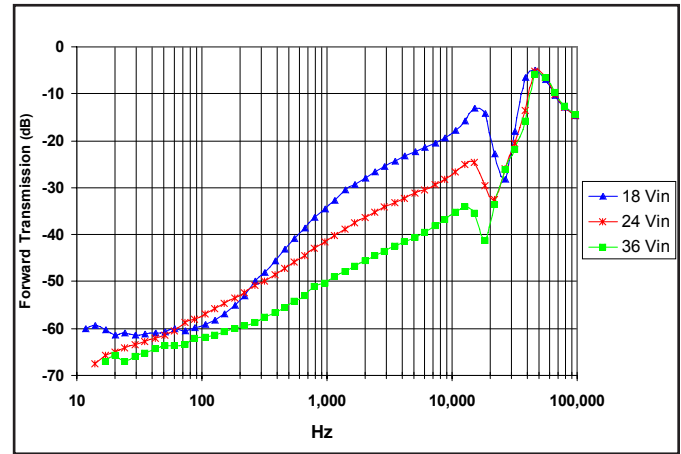

Figure 20: Magnitude of incremental forward transmission ($FT = v_{out}/v_{in}$) for minimum, nominal, and maximum input voltage at full rated power.

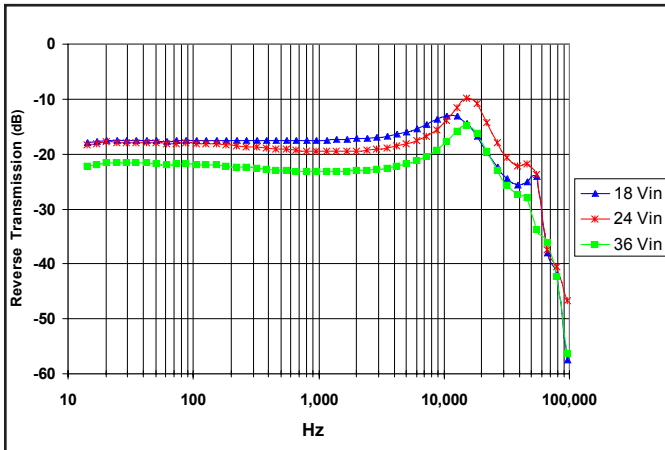

Figure 21: Magnitude of incremental reverse transmission ($RT = i_{in}/i_{out}$) for minimum, nominal, and maximum input voltage at full rated power.

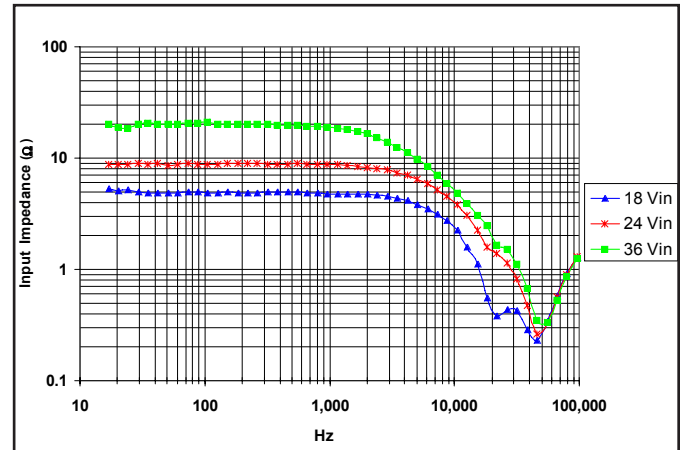

Figure 22: Magnitude of incremental input impedance ($Z_{in} = v_{in}/i_{in}$) for minimum, nominal, and maximum input voltage at full rated power.

BASIC OPERATION AND FEATURES

The *PowerQor* series converter uses a two-stage power circuit topology. The first stage is a buck-converter that keeps the output voltage constant over variations in line, load, and temperature. The second stage uses a transformer to provide the functions of input/output isolation and voltage step-down to achieve the low output voltage required.

Both the first stage and the second stage switch at a fixed frequency for predictable EMI performance. Rectification of the transformer's output is accomplished with synchronous rectifiers. These devices, which are MOSFETs with a very low on-state resistance, dissipate far less energy than Schottky diodes used in conventional dc/dc converters. This is the primary reason that the *PowerQor* converter has such high efficiency—even at very low output voltages and very high output currents.

Dissipation throughout the converter is so low that the **PowerQor converter requires no heatsink** to deliver a greater level of power than can be delivered by a conventional, Schottky-diode-based dc/dc converter with a 0.5" high heatsink. At equivalent ambient air temperature, airflow rate, and output power level, the hottest semiconductor junction temperature and the hottest PCB temperature within the *PowerQor* converter are cooler than those found in conventional dc/dc converters with a 0.5" high heatsink attached.

Since a heatsink is not required, the *PowerQor* converter does not need a metal baseplate or potting material to help conduct the dissipated energy to the heatsink. The *PowerQor* converter can thus be built more simply using high yield surface mount techniques on a PCB substrate.

Unlike conventional dc/dc converters, which have critical thermal connections between the power components and the baseplate, and between the baseplate and the heatsink, the *PowerQor* converter has no explicit, failure-prone thermal connections.

Compared to a conventional Schottky-diode-based dc/dc converter with a 0.5" high heatsink, the *PowerQor* converter is more efficient and therefore it dissipates less than half the energy. Additionally, because the *PowerQor* converter is thinner (0.4" vs. 1.0"), the board-to-board pitch in a rack can be much smaller, and cooling airflow is less impeded by

the converter. Because the *PowerQor* converter is much lighter, vibration and shock-induced problems are greatly reduced. Moreover, due to the lack of failure-prone explicit thermal connections and the lack of potting material the *PowerQor* converter is more reliable than conventional dc/dc converters.

The *PowerQor* series converter uses the industry standard pin-out configuration used by other vendors of comparably sized and rated dc/dc converters. The unit is pin for pin compatible with the Lucent QW series.

The *PowerQor* converter has many standard control and protection features. All shutdown features are non-latching, meaning that the converter shuts off for 200ms before restarting. (see *Figure F*)

- An **ON/OFF** input permits the user to control when the converter is *on* and *off* in order to properly sequence different power supplies and to reduce power consumption during a standby condition.
- **Remote sense** inputs permit the user to maintain an accurate voltage at the load despite distribution voltage drops between the converter's output and the load.
- An **output voltage trim** input permits the user to trim the output voltage up or down to achieve a custom voltage level or to do voltage margining.
- An **input under-voltage lockout** avoids input system instability problems while the input voltage is rising.
- The **output current limit** protects both the converter and the board on which it is mounted against a short circuit condition. (see *Figure 18*)
- An **output over-voltage limit** circuit shuts the unit down if the output voltage at the output pins gets too high.
- A sensor located in a central spot of the PCB provides a **PCB temperature limit**. If, due to an abnormal condition, this spot gets too hot, the converter will turn off. Once the converter has cooled, it will automatically turn on again without the need to recycle the input power.

CONTROL PIN DESCRIPTIONS

Pin 2 (ON/OFF): The ON/OFF input, Pin 2, permits the user to control when the converter is *on* or *off*. This input is

referenced to the return terminal of the 24V input bus. There are two versions of the PowerQor series converter that differ by the sense of the logic used for the ON/OFF input. In the PQxyyyQGazzPxx version, the ON/OFF input is active high (meaning that a high turns the converter on). In the PQxyyyQGazzNxx version, the ON/OFF signal is active low (meaning that a low turns the converter on). Figure A details five possible circuits for driving the ON/OFF pin. Figure B shows detail of the internal ON/OFF circuitry.

Pins 7 and 5 (SENSE(±)): The SENSE(±) inputs correct for voltage drops along the conductors that connect the converter's output pins to the load.

Pin 7 should be connected to Vout(+) and Pin 5 should be connected to Vout(-) at the point on the board where regulation is desired. That is,

$$[V_{out(+)} - V_{out(-)}] - [SENSE(+)-SENSE(-)] \leq 10\%V_{out}$$

Pins 7 and 5 must be connected for proper regulation of the output voltage. However, if these connections are not made, nothing catastrophic will happen to the converter under normal operating conditions—the converter will simply deliver an output voltage that is slightly higher than its specified value.

Note: the output over-voltage protection circuit senses the

voltage across the output (pins 8 and 4) to determine when it should trigger, not the voltage across the converter's sense pins (pins 7 and 5). Therefore, the resistive drop on the board should be small enough so that output OVP does not trigger, even during load transients.

Pin 6 (TRIM): The TRIM input permits the user to adjust the output voltage across the sense leads up or down. To lower the output voltage, the user should connect a resistor between Pin 6 and Pin 5, which is the SENSE(-) input. To raise the output voltage, the user should connect a resistor between Pin 6 and Pin 7, which is the SENSE(+) input.

A resistor connected between Pin 6 and Pin 5 will decrease the output voltage. For a desired decrease of Δ percent of the nominal output voltage, the value of this resistor should be

$$R_{trim-down} = \left(\frac{511}{\Delta\%} \right) - 10.22 \text{ (k}\Omega\text{)}$$

where

$$\Delta = \left(\frac{V_{NOM} - V_{DES}}{V_{NOM}} \right) \times 100\%$$

and

V_{NOM} = Nominal Voltage

V_{DES} = Desired Voltage

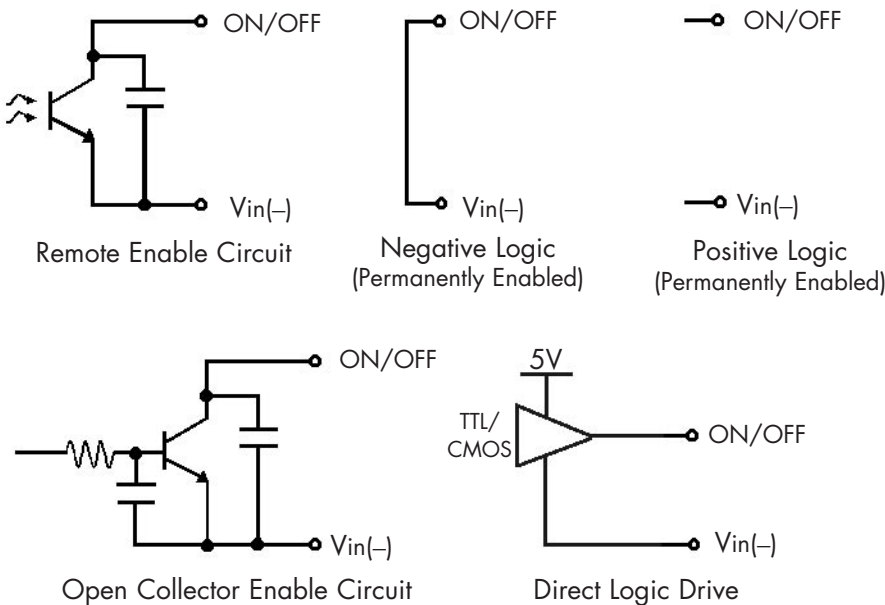

Figure A: Various circuits for driving the ON/OFF pin.

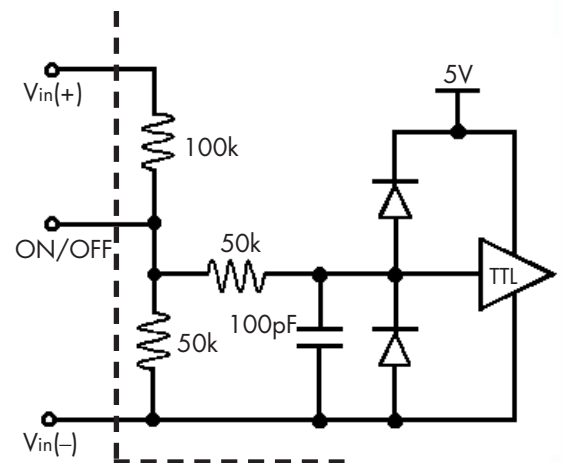

Figure B: Internal ON/OFF pin circuitry (detail)

Figure C graphs this relationship between $R_{\text{trim-down}}$ and Δ . The output voltage can be trimmed down as much as 20%.

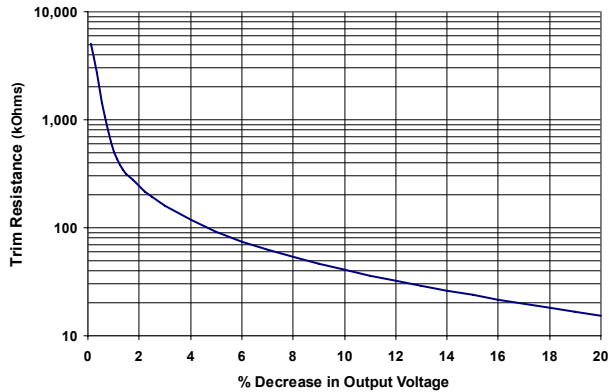

Figure C: Trim Down Graph for 1.8V_{out}

A resistor connected between Pin 6 and Pin 7 will increase the output voltage. For a desired increase of Δ percent of the nominal output voltage, the value of this resistor should be

$$R_{\text{trim-up}} = \left(\frac{5.11V_{\text{OUT}}(100+\Delta\%)}{1.225\Delta\%} - \frac{511}{\Delta\%} - 10.22 \right) (\text{k}\Omega)$$

where

$$V_{\text{OUT}} = \text{Nominal Output Voltage}$$

Figure D graphs this relationship between $R_{\text{trim-up}}$ and Δ . The output voltage can be trimmed up as much as 10%.

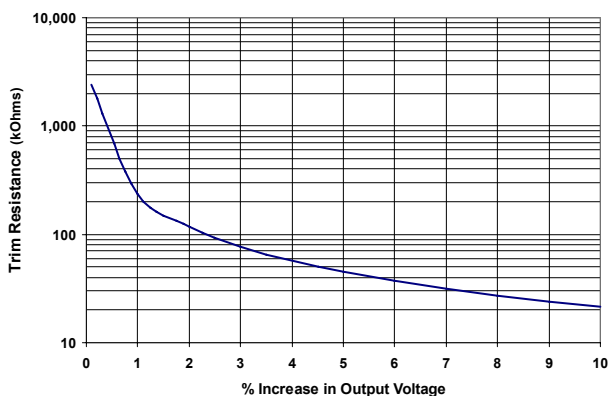

Figure D: Trim Up Graph for 1.8V_{out}

Note: The TRIM feature does not affect the voltage at which the output over-voltage protection circuit is triggered. Trimming the output voltage too high may cause the over-voltage protection circuit to trip, particularly during transients.

TOTAL DC VARIATION OF V_{out}: For the converter to meet its full specifications, the maximum variation of the dc value of V_{out}, due to both trimming and remote load voltage drops, should not be greater than +10%/-20%

PROTECTION FEATURES

Input Under-Voltage Lockout: The converter is designed to turn off when the input voltage is too low, helping avoid an input system instability problem, described in more detail below. The lockout circuitry is a comparator with dc hysteresis. When the input voltage is rising, it must exceed a typical value of 16V before the converter will turn on. Once the converter is on, the input voltage must fall below a typical value of 14.5V before the converter will turn off.

Output Current Limit: The current limit does not change appreciably as the output voltage drops. However, once the impedance of the short across the output is small enough to make the output voltage drop below approximately 60% of its nominal value, the converter turns off.

The converter then enters a mode where it repeatedly turns on and off at a 5 Hz (nominal) frequency with a 5% duty cycle until the short circuit condition is removed. This prevents excessive heating of the converter or the load board.

Output Over-Voltage Limit: If the voltage across the output pins exceeds the O.V. threshold, the converter will immediately stop switching. This prevents damage to the load circuit due to 1) a sudden unloading of the converter, 2) a release of a short-circuit condition, or 3) a release of a current limit condition. Load capacitance determines exactly how high the output voltage will rise in response to these conditions. After 200 ms the converter will automatically restart.

Thermal Shutdown: The PowerQor series has a temperature sensor located such that it senses the average temperature of the converter. The thermal shutdown circuit is designed to turn the converter off when the temperature at the sensed location reaches 125°C. It will allow the con-

verter to turn on again when the temperature of the sensed location falls below 115°C.

APPLICATION CONSIDERATIONS

Input System Instability: This condition can occur because a dc/dc converter appears incrementally as a negative resistance load. A detailed application note titled "Input System Instability" is available on the SynQor web site (www.synqor.com) which provides an understanding of why this instability arises, and shows the preferred solution for correcting it.

Application Circuits: Figure E below provides a typical circuit diagram which is useful when using input filtering and voltage trimming.

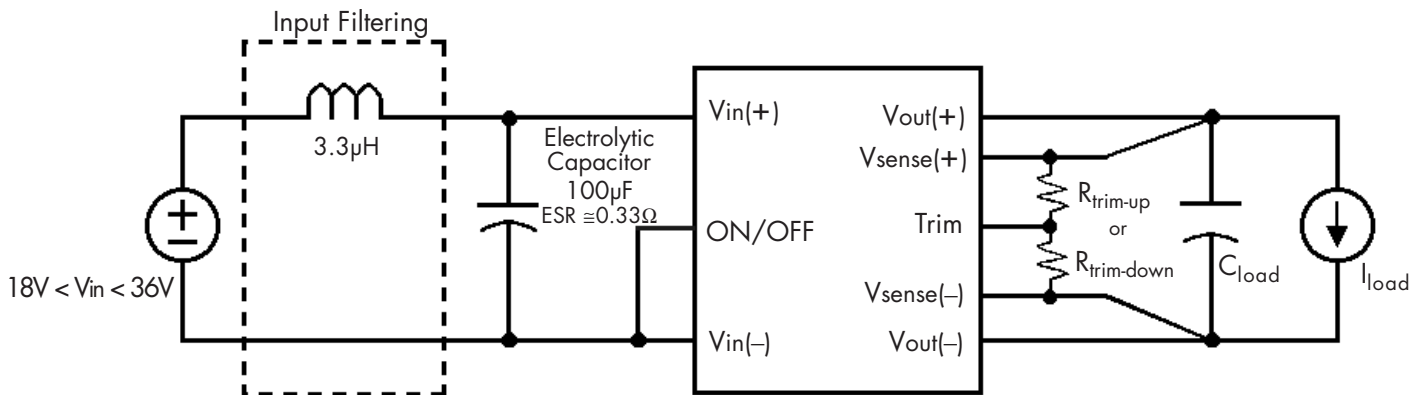

Figure E: Typical application circuit (negative logic unit, permanently enabled).

STARTUP INHIBIT PERIOD

The Startup Inhibit Period ensures that the converter will remain off for at least 200ms when it is shut down for any reason. When an output short is present, this generates a 5Hz "hiccup mode," which prevents the converter from overheating. In all, there are seven ways that the converter can be shut down, initiating a Startup Inhibit Period:

- Input Under-Voltage Lockout
- Input Over-Voltage Shutdown (not present in Quarter-brick)
- Output Over-Voltage Protection
- Over Temperature Shutdown
- Current Limit
- Short Circuit Protection
- Turned off by the ON/OFF input

Figure F shows three turn-on scenarios, where a Startup Inhibit Period is initiated at t_0 , t_1 , and t_2 :

Before time t_0 , when the input voltage is below 16V (typ.), the unit is disabled by the Input Under-Voltage Lockout feature. When the input voltage rises above 16V, the Input Under-Voltage Lockout is released, and a Startup Inhibit Period is initiated. At the end of this delay, the ON/OFF pin is evaluated, and since it is active, the unit turns on.

At time t_1 , the unit is disabled by the ON/OFF pin, and it cannot be enabled again until the Startup Inhibit Period has elapsed.

When the ON/OFF pin goes high after t_2 , the Startup Inhibit Period has elapsed, and the output turns on within the 4ms (typ.) "Turn On Time."

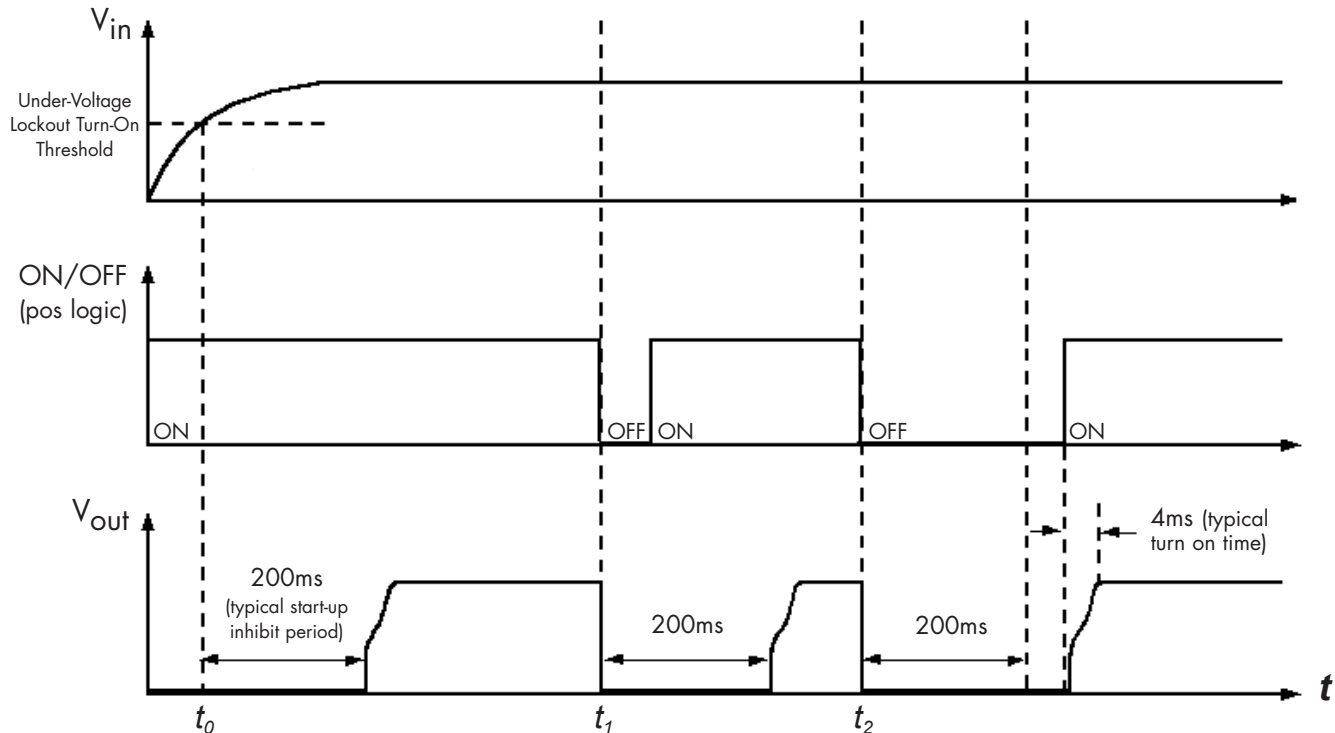
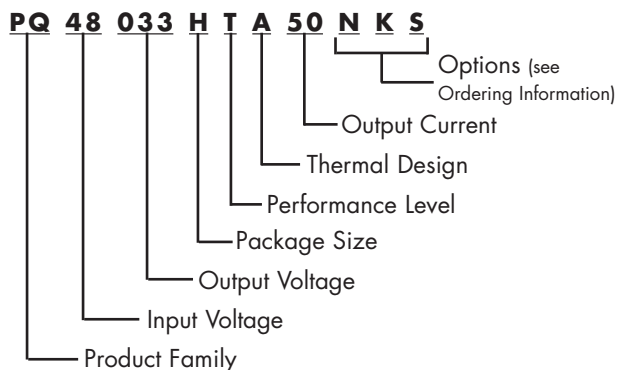

Figure F: Startup Inhibit Period (turn-on time not to scale)

PART NUMBERING SYSTEM

The part numbering system for SynQor's PowerQor DC/DC converters follows the format shown in the example below.



The first 12 characters comprise the base part number and the last 3 characters indicate available options. Although there are no default values for enable logic and pin length, the most common options are negative logic and 0.145" pins. These part numbers are more likely to be readily available in stock for evaluation and prototype quantities.

Application Notes Available

- Current Sharing for Full Feature Modules
- EMI Characteristics
- Thermal Relief Vias
- Input System Instability

All application notes and technical white papers can be downloaded in pdf format at www.synqor.com.

Contact SynQor for further information:

Phone: 978-567-9596
Toll Free: 888-567-9596
Fax: 978-567-9599
E-mail: sales@synqor.com
Web: www.synqor.com
Address: 188 Central Street
Hudson, MA 01749

ORDERING INFORMATION

The tables below show the valid model numbers and ordering options for converters in this product family. When ordering SynQor converters, please ensure that you use the complete 15 character part number consisting of the 12 character base part number and the additional 3 characters for options.

Model Number	Input Voltage	Output Voltage	Max Output Current	Full Load Efficiency
PQ24018QGA25xyz	18 - 36 V	1.8 V	25 A	84%
PQ24033QGA25xyz	18 - 36 V	3.3 V	25 A	87%
PQ24050QGA20xyz	18 - 36 V	5.0 V	20 A	87%
PQ24120QGA08xyz	18 - 36 V	12 V	8.3 A	88%
PQ24150QGA07xyz	18 - 36 V	15 V	6.7 A	87%

The following option choices must be included in place of the x y z spaces in the model numbers listed above.

Options Description: x y z		
Enable Logic	Pin Length	Feature Set
P - Positive N - Negative	K - 0.110" N - 0.145" R - 0.180" Y - 0.250"	S - Standard

Warranty

SynQor offers a three (3) year limited warranty. Complete warranty information is listed on our web site or is available upon request from SynQor.

Information furnished by SynQor is believed to be accurate and reliable. However, no responsibility is assumed by SynQor for its use, nor for any infringements of patents or other rights of third parties which may result from its use. No license is granted by implication or otherwise under any patent or patent rights of SynQor.