



### Features

- *Optiguard*™ coated for improved reliability
- Eight channels of EMI filtering
- Three C-L-C filters with ESD protection for stereo speaker port
- Five C-R-C filters with ESD protection for microphone and data ports
- $\pm 15\text{kV}$  ESD protection on each channel (IEC 61000-4-2 Level 4, contact discharge)
- $\pm 30\text{kV}$  ESD protection on each channel (HBM)
- Chip Scale Package (CSP) features extremely low parasitic inductance for optimum filter and ESD performance
- 20 bump, 3.960mm x 1.586mm footprint CSP
- RoHS compliant (lead-free)

### Applications

- Combination I/O data port that has I/Os for data, microphone and speaker
- I/O port protection for mobile handsets, notebook computers, PDAs etc
- "EMI filtering for data ports in cell phones, PDAs or notebook computers
- Wireless Handsets
- Handheld PCs / PDAs

### Product Description

The CM1454 is an EMI filter array with ESD protection in a CSP form factor for the data port of a mobile handset. The CM1454-08 is configured in an 8 channel format and combines both resistor-capacitor (R-C) and inductor-capacitor (L-C) filters in the chip. There are five C-R-C filters with component values of 30pF-100 -30pF which are used for the microphone and data ports. There are also three C-L-C filters with values of 80pF-3nH-80pF which are designed for the stereo speaker port.

The CM1454's C-RC filters have a cut-off frequency of 60MHz and an attenuation of better than 35dB over the 800MHz to 2.7GHz frequency range. The C-L-C filters have a cut-off frequency of 21MHz with an attenuation of 40dB at 1Ghz. The parts integrate ESD protection diodes on every pin that provide a very high level of protection for sensitive electronic components against possible electrostatic discharge (ESD). The ESD protection diodes connected to the filter ports are designed and characterized to safely dissipate ESD strikes of  $\pm 15\text{kV}$ , which is beyond the Level 4 requirement of the IEC61000-4-2 international standard. In accordance with MIL-STD-883 (Method 3015) specification for Human Body Model (HBM) ESD, the pins are also protected for contact discharges at greater than  $\pm 30\text{kV}$ .

The CM1454 incorporates *OptiGuard*™ which results in improved reliability at assembly. The CM1454 is available in a space saving, low profile Chip Scale Package with, RoHS compliant, lead-free finishing.

Electrical Schematic

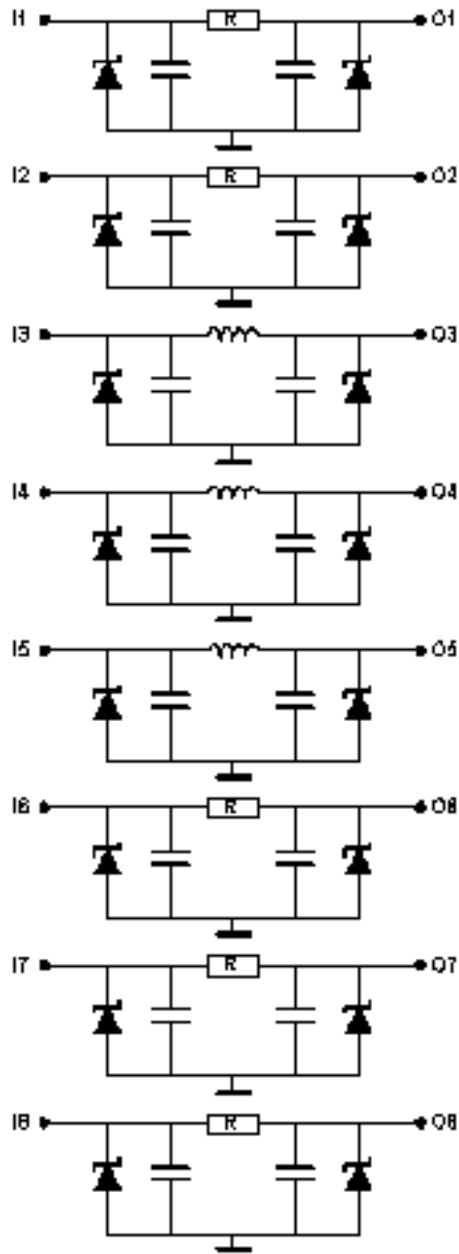
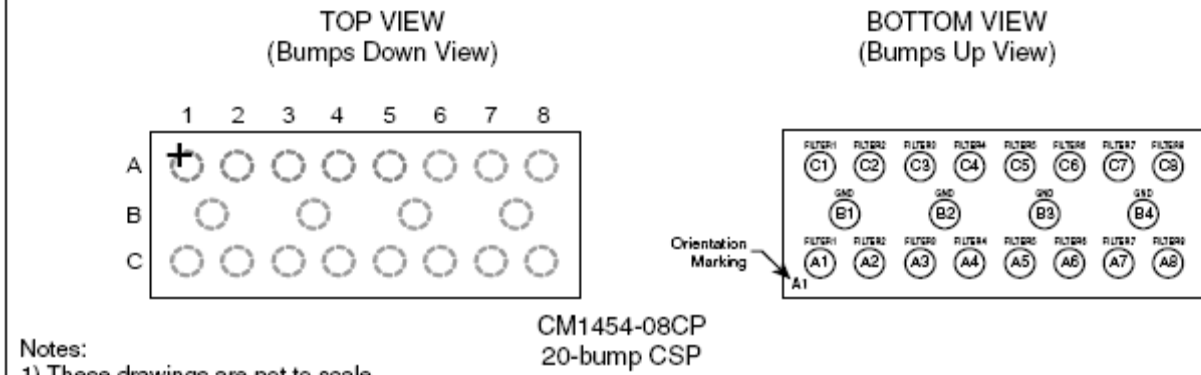

Figure 1. CM1454 Schematic Diagram of R-C and L-C Filter Arrays with ESD

# CM1454

## PACKAGE / PINOUT DIAGRAMS



## PIN DESCRIPTIONS

PIN NUMBER	PIN DESCRIPTION	PIN NUMBER	PIN DESCRIPTION
A1	Filter #1 (Microphone)	B3	GND
A2	Filter #2 (Microphone)	B4	GND
A3	Filter #3 (Stereo Headphone)	C1	Filter #1
A4	Filter #4 (Left Speaker)	C2	Filter #2
A5	Filter #5 (Right Speaker)	C3	Filter #3
A6	Filter #6 (Accessory ID)	C4	Filter #4
A7	Filter #7 (Data)	C5	Filter #5
A8	Filter #8(Data)	C6	Filter #6
B1	GND	C7	Filter #7
B2	GND	C8	Filter #8

## Ordering Information

PART NUMBERING INFORMATION			
Bumps	Package	Lead-free Finish	
		Ordering Part Number <sup>1</sup>	Part Marking
20	CSP	CM1454-08CP	N548

Note 1: Parts are shipped in Tape & Reel form unless otherwise specified.

## Specifications

ABSOLUTE MAXIMUM RATINGS		
PARAMETER	RATING	UNITS
Storage Temperature Range	-65 to +150	°C
DC current per Inductor	30	mA
DC Package Power Rating	0.5	W

STANDARD OPERATING CONDITIONS		
PARAMETER	RATING	UNITS
Operating Temperature Range	-40 to +85	°C

**ELECTRICAL OPERATING CHARACTERISTICS** (NOTE 1)

SYMBOL	PARAMETER	CONDITIONS	MIN	TYP	MAX	UNITS
R	Resistance		80	100	120	$\Omega$
C <sub>1</sub>	Capacitance	2.5V dc; 1MHz, 30mV ac	24	30	36	pF
L	Inductance			3.0		nH
R <sub>E</sub>	Equivalent Series Resistance of Inductor			0.25		$\Omega$
C <sub>2</sub>	Capacitance	0V dc; 1MHz, 30mV ac;	100	125	150	pF
		2.5V dc; 1MHz, 30mV ac;	64	80	96	pF
f <sub>RC</sub>	Cut-off frequency Z <sub>SOURCE</sub> = 50 $\Omega$ , Z <sub>LOAD</sub> = 50 $\Omega$			60		MHz
f <sub>LC</sub>	Cut-off frequency Z <sub>SOURCE</sub> = 50 $\Omega$ , Z <sub>LOAD</sub> = 50 $\Omega$			21		MHz
V <sub>ST</sub>	Stand-off Voltage	I = 10 $\mu$ A		6.0		V
I <sub>LEAK</sub>	Diode Leakage Current	V <sub>IN</sub> = 3.3V		0.1	1.0	$\mu$ A
V <sub>SIG</sub>	Signal Clamp Voltage	I <sub>LOAD</sub> = 10mA I <sub>LOAD</sub> = -10mA	5.6 -1.5	6.8 -0.8	9.0 -0.4	V V
	Positive Clamp					
V <sub>ESD</sub>	In-system ESD Withstand Voltage a) Human Body Model, MIL-STD-883, Method 3015 b) Contact Discharge per IEC 61000-4-2 Level 4	Notes 2 and 3	$\pm$ 30			kV
						$\pm$ 15
R <sub>DYN</sub>	Dynamic Resistance			2.3		$\Omega$
				0.9		$\Omega$

Note 1: T<sub>A</sub>=25°C unless otherwise specified.

Note 2: ESD applied to input and output pins with respect to GND, one at a time.

Note 3: Unused pins are left open.

## Performance Information

Typical Filter Performance (nominal conditions unless specified otherwise, 50 Ohm Environment)

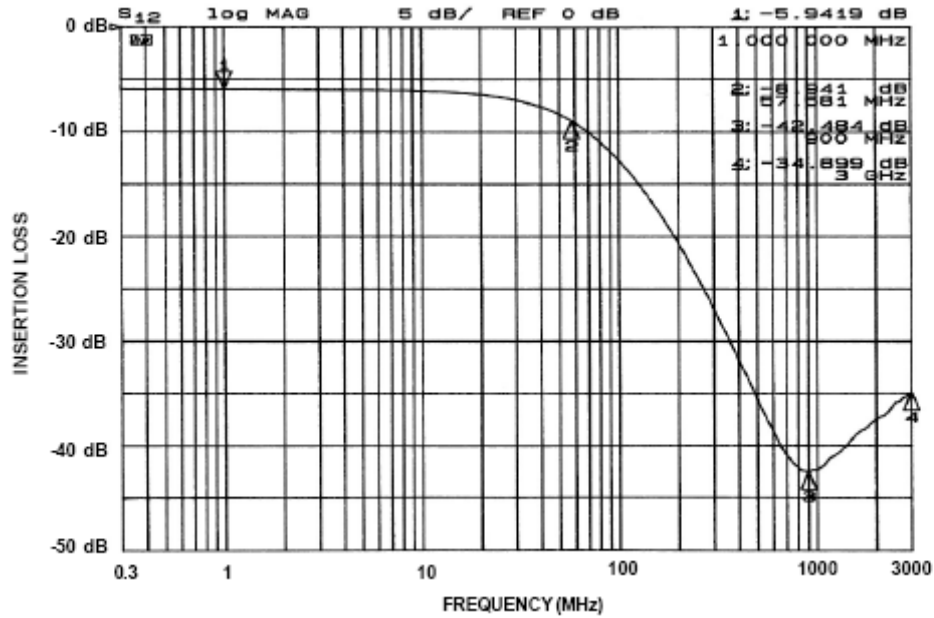

Figure 2. Attenuation Curve for CM1454 RC Filters: 1, 2, 6, 7, and 8

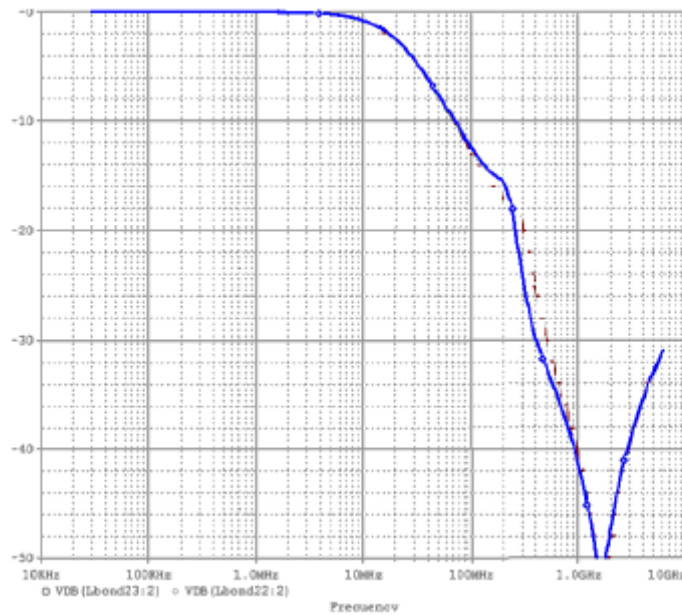

Figure 3. Attenuation Curve for CM1454 RC Filters: 3, 4, and 5

Diode Characteristics (nominal conditions unless specified otherwise)

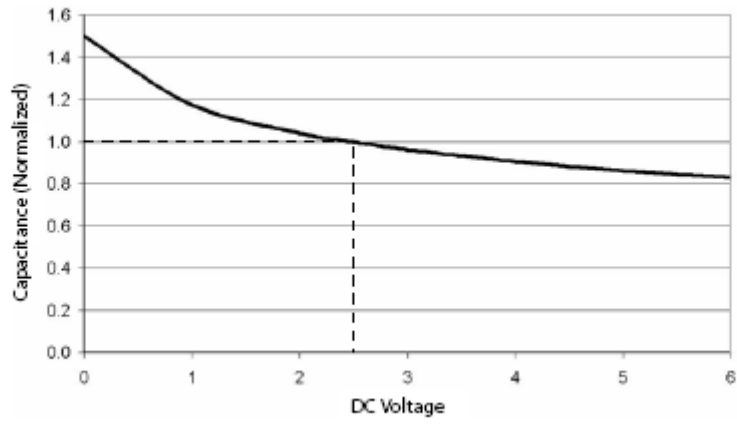

Figure 4. Typical Diode Capacitance VS. Input Voltage (normalized to 2.5VDC)

## Application Information

PARAMETER	VALUE
Pad Size on PCB	0.240mm
Pad Shape	Round
Pad Definition	Non-Solder Mask defined pads
Solder Mask Opening	0.290mm Round
Solder Stencil Thickness	0.125mm - 0.150mm
Solder Stencil Aperture Opening (laser cut, 5% tapered walls)	0.300mm Round
Solder Flux Ratio	50/50 by volume
Solder Paste Type	No Clean
Pad Protective Finish	OSP (Entek Cu Plus 106A)
Tolerance — Edge To Corner Ball	$\pm 50\mu\text{m}$
Solder Ball Side Coplanarity	$\pm 20\mu\text{m}$
Maximum Dwell Time Above Liquidous	60 seconds
Maximum Soldering Temperature for Lead-free Devices using a Lead-free Solder Paste	260°C

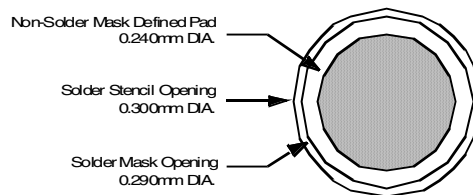

Figure 5. Recommended Non-Solder Mask Defined Pad Illustration

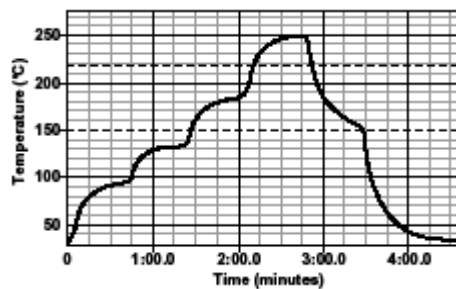

Figure 6. Lead-free (SnAgCu) Solder Ball Reflow Profile



# CM1454

## Mechanical Specifications

CM1454 devices are packaged in custom Chip Scale Packages (CSP). See Application Note AP-217 for more information at: <http://www.wlcsforum.org/documents/pdf/ap-217.pdf>.

PACKAGE DIMENSIONS						
Package	Custom CSP					
Bumps	20					
Dim	Millimeters			Inches		
	Min	Nom	Max	Min	Nom	Max
A1	3.915	3.960	4.005	0.1541	0.1559	0.1577
A2	1.541	1.586	1.631	0.0607	0.0624	0.0642
B1	0.495	0.500	0.505	0.0195	0.0197	0.0199
B2	0.245	0.250	0.255	0.0096	0.0098	0.0100
B3	0.430	0.435	0.440	0.0169	0.0171	0.0173
B4	0.430	0.435	0.440	0.0169	0.0171	0.0173
C1	0.180	0.230	0.280	0.0071	0.0091	0.0110
C2	0.308	0.358	0.408	0.0121	0.0141	0.0161
D1	0.574	0.644	0.714	0.0226	0.0254	0.0281
D2	0.368	0.419	0.470	0.0145	0.0165	0.0185
# per tape and reel	3500 pieces					
Controlling dimension: millimeters						

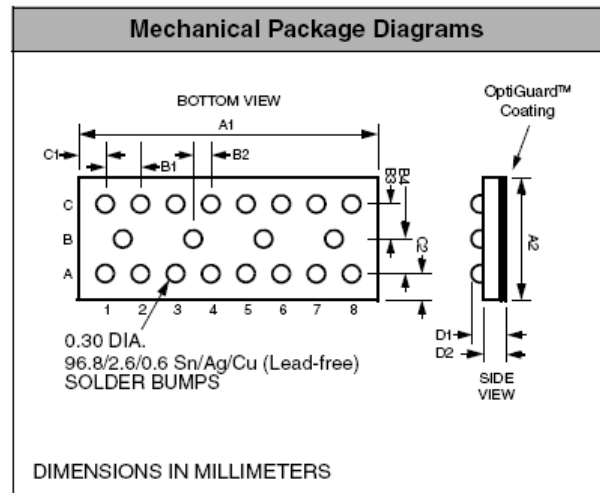

**Package Dimensions for  
CM1454-08CP Chip Scale Package**

**CSP Tape and Reel Specifications**

PART NUMBER	CHIP SIZE (mm)	POCKET SIZE (mm) B <sub>0</sub> X A <sub>0</sub> X K <sub>0</sub>	TAPE WIDTH W	REEL DIAMETER	QTY PER REEL	P <sub>0</sub>	P <sub>1</sub>
CM1454-08CP	3.96 X 1.586X 0.640	4.06 X 1.98 X 0.76	12mm	330mm (13")	3500	4mm	4mm

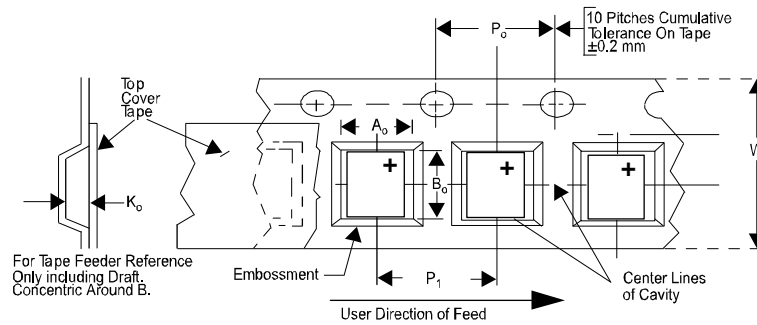

ON Semiconductor and are registered trademarks of Semiconductor Components Industries, LLC (SCILLC). SCILLC reserves the right to make changes without further notice to any products herein. SCILLC makes no warranty, representation or guarantee regarding the suitability of its products for any particular purpose, nor does SCILLC assume any liability arising out of the application or use of any product or circuit, and specifically disclaims any and all liability, including without limitation special, consequential or incidental damages. "Typical" parameters which may be provided in SCILLC data sheets and/or specifications can and do vary in different applications and actual performance may vary over time. All operating parameters, including "Typicals" must be validated for each customer application by customer's technical experts. SCILLC does not convey any license under its patent rights nor the rights of others. SCILLC products are not designed, intended, or authorized for use as components in systems intended for surgical implant into the body, or other applications intended to support or sustain life, or for any other application in which the failure of the SCILLC product could create a situation where personal injury or death may occur. Should Buyer purchase or use SCILLC products for any such unintended or unauthorized application, Buyer shall indemnify and hold SCILLC and its officers, employees, subsidiaries, affiliates, and distributors harmless against all claims, costs, damages, and expenses, and reasonable attorney fees arising out of, directly or indirectly, any claim of personal injury or death associated with such unintended or unauthorized use, even if such claim alleges that SCILLC was negligent regarding the design or manufacture of the part. SCILLC is an Equal Opportunity/Affirmative Action Employer. This literature is subject to all applicable copyright laws and is not for resale in any manner.

**PUBLICATION ORDERING INFORMATION**

**LITERATURE FULFILLMENT:**  
Literature Distribution Center for ON Semiconductor  
P.O. Box 5163, Denver, Colorado 80217 USA  
**Phone:** 303-675-2175 or 800-344-3860 Toll Free USA/Canada  
**Fax:** 303-675-2176 or 800-344-3867 Toll Free USA/Canada  
**Email:** orderlit@onsemi.com

**N. American Technical Support:** 800-282-9855  
Toll Free USA/Canada  
**Europe, Middle East and Africa Technical Support:**  
Phone: 421 33 790 2910  
**Japan Customer Focus Center**  
Phone: 81-3-5773-3850

ON Semiconductor Website: [www.onsemi.com](http://www.onsemi.com)

Order Literature: <http://www.onsemi.com/orderlit>

For additional information, please contact your local Sales Representative