

## Features

- Attenuation: 1.0 dB Steps to 31.0 dB
- Phase error:  $\pm 3^\circ$  Typical at 2 GHz
- Low DC Power Consumption
- Small Footprint, PQFN Package
- Integral TTL Driver
- 50 ohm Impedance
- Test Boards are Available
- RoHS\* Compliant

## Description

M/A-COM's MAAD-008790-000100 is a GaAs pHEMT 5-bit digital attenuator with integral TTL driver. This attenuator was designed to minimize phase variation over attenuation. Step size is 1.0 dB providing a 31.0 dB total attenuation range. This device is in an PQFN plastic surface mount package. MAAD-008790-000100 is ideally suited for use where accuracy, constant phase over attenuation, very low power consumption and low costs are required.

## Ordering Information

Part Number	Package
MAAD-008790-000100	Bulk Packaging
MAAD-008790-0001TR	1000 piece reel
MAAD-008790-0001TB	Sample Test Board

Note: Reference Application Note M513 for reel size information.

\* Restrictions on Hazardous Substances, European Union Directive 2002/95/EC.

## Functional Schematic

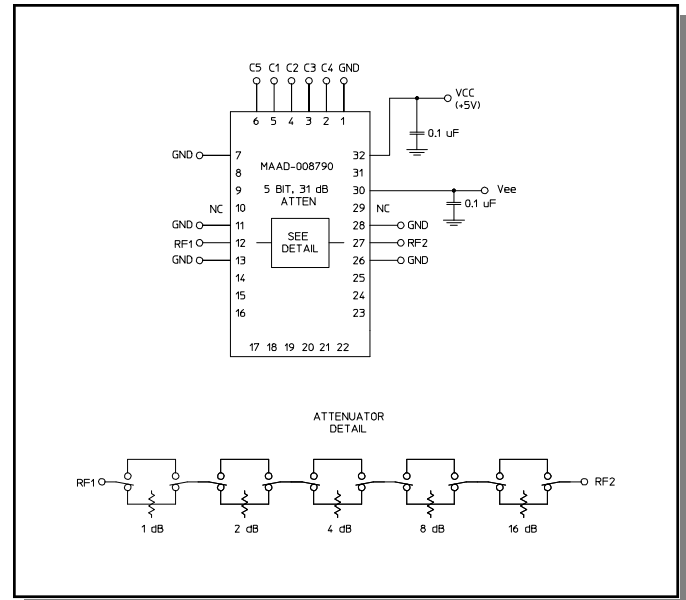

## Pin Configuration<sup>1</sup>

Pin No.	Function	Pin No.	Function
1	GND	17	NC
2	C4	18	NC
3	C3	19	NC
4	C2	20	NC
5	C1	21	NC
6	C5	22	NC
7	GND	23	NC
8	NC	24	NC
9	NC	25	NC
10	NC <sup>2</sup>	26	GND
11	GND	27	RF2
12	RF1	28	GND
13	GND	29	NC <sup>2</sup>
14	NC	30	Vee
15	NC	31	NC
16	NC	32	+Vcc

1. The exposed pad centered on the package bottom must be connected to RF and DC ground. (For PQFN Packages)
2. Pins 10 & 29 must be isolated

• North America Tel: 800.366.2266 • Europe Tel: +353.21.244.6400  
 • India Tel: +91.80.4155721 • China Tel: +86.21.2407.1588  
 Visit [www.macomtech.com](http://www.macomtech.com) for additional data sheets and product information.

M/A-COM Technology Solutions Inc. and its affiliates reserve the right to make changes to the product(s) or information contained herein without notice.

## Constant Phase Digital Attenuator 32 dB, 2-Bit, TTL Driver, DC-3.0 GHz

Rev. V1

**Electrical Specifications:  $T_A = 25^\circ\text{C}$ ,  $Z_0 = 50\Omega$ ,  $V_{CC} = +5.0\text{V}$ ,  $V_{EE} = -5.0\text{V}$**

Parameter	Test Conditions	Frequency	Units	Min	Typ	Max
Operating Power	—	—	dBm	—	—	+20
Reference Insertion Loss	—	DC - 2.0 GHz 2.0 - 4.0 GHz	dB dB	— —	— —	5.0 5.5
Attenuation Accuracy <sup>3</sup> Relative to Reference Loss State	Any Single Bit Any Combination of Bits	DC - 4.0 GHz DC - 4.0 GHz	±(0.3 +3% of atten setting in dB) ±(0.3 +3% of atten setting in dB)			
Phase Accuracy Relative to Reference Loss State	Any Single Bit	DC - 2.0 GHz	deg	—	—	±3°
	Any Single Bit	2.0 - 4.0 GHz	deg	—	—	±5°
	Any Combination of Bits	DC - 2.0 GHz	deg	—	—	±5°
	Any Combination of Bits	2.0 - 4.0 GHz	deg	—	—	±9°
VSWR	Full Range	DC - 4.0 GHz	Ratio	—	—	1.8:1
Switching Speed	Ton	1.3 V Cntl to 90% RF	ns	—	See Table	—
	Toff	1.3 V Cntl to 10% RF	ns	—	13	—
	Trise	10% RF to 90% RF	ns	—	See Table	—
	Tfall	90% RF to 10% RF	ns	—	3	—
1 dB Compression <sup>4</sup>	Reference State	0.05 GHz	dBm	—	>+27	—
	Reference State	0.5 - 4.0 GHz	dBm	—	>+27	—
Input IP3	Two-tone inputs up to +5 dBm	0.05-4.0 GHz	dBm	—	See Table	—
Input IP2	Two-tone inputs up to +5 dBm	0.05-4.0 GHz	dBm	—	See Table	—
V <sub>CC</sub>	—	—	V	4.5	5.0	5.5
V <sub>EE</sub>	—	—	V	-8.0	-5.0	-4.5
V <sub>IL</sub>	LOW-level input voltage	—	V	0.0	0.0	0.8
V <sub>IH</sub>	HIGH-level input voltage	—	V	2.0	5.0	5.0
I <sub>in</sub> (Input Leakage Current)	V <sub>in</sub> = V <sub>CC</sub> or GND	—	uA	-1	—	1
I <sub>CC</sub> (Quiescent Supply Current)	V <sub>cntrl</sub> = V <sub>CC</sub> or GND	—	uA	—	250	400
ΔI <sub>CC</sub> (Additional Supply Current Per TTL Input Pin)	V <sub>CC</sub> = Max V <sub>cntrl</sub> = V <sub>CC</sub> - 2.1 V	—	mA	—	—	1.5
I <sub>EE</sub>	V <sub>EE</sub> min to max V <sub>in</sub> = V <sub>IL</sub> or V <sub>IH</sub>	—	mA	-1.0	-0.2	—
Thermal Resistance θ <sub>JC</sub>	—	—	°C/W	—	35	—

- This attenuator is guaranteed monotonic.
- 1 dB Compression was measured up to +27 dBm, which is the absolute maximum rating for this device.

## Absolute Maximum Ratings <sup>5,6</sup>

Parameter	Absolute Maximum
Max. Input Power	+27 dBm
V <sub>CC</sub>	-0.5V ≤ V <sub>CC</sub> ≤ +7.0V
V <sub>EE</sub>	-8.5V ≤ V <sub>EE</sub> ≤ +0.5V
V <sub>CC</sub> - V <sub>EE</sub>	-0.5V ≤ V <sub>CC</sub> - V <sub>EE</sub> ≤ 14.5V
V <sub>in</sub> <sup>7</sup>	-0.5V ≤ V <sub>in</sub> ≤ V <sub>CC</sub> + 0.5V
Operating Temperature	-40°C to +85°C
Storage Temperature	-65°C to +125°C

- Exceeding any one or combination of these limits may cause permanent damage to this device.
- M/A-COM does not recommend sustained operation near these survivability limits.
- Standard CMOS TTL interface, latch-up will occur if logic signal is applied prior to power supply.

## Recommended PCB Configuration <sup>8</sup>

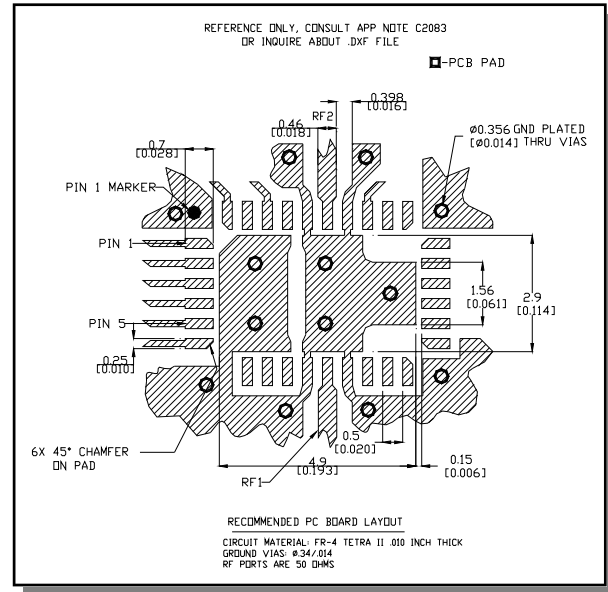

- Application Note S2083 is available on line at [www.macom.com](http://www.macom.com)

## Handling Procedures

Please observe the following precautions to avoid damage:

### Static Sensitivity

Gallium Arsenide Integrated Circuits are sensitive to electrostatic discharge (ESD) and can be damaged by static electricity. Proper ESD control techniques should be used when handling these devices.

### Moisture Sensitivity

The MSL rating for this part is defined as Level 2 per IPC/JEDEC J-STD-020. Parts shall be stored and/or baked as required for MSL Level 2 parts.

## Truth Table (Digital Attenuator)

C5	C4	C3	C2	C1	Attenuation
0	0	0	0	0	Loss, Reference
0	0	0	0	1	1.0 dB
0	0	0	1	0	2.0 dB
0	0	1	0	0	4.0 dB
0	1	0	0	0	8.0 dB
1	0	0	0	0	16.0 dB
1	1	1	1	1	31.0 dB

0 = TTL Low; 1 = TTL High

## Constant Phase Digital Attenuator 32 dB, 2-Bit, TTL Driver, DC-3.0 GHz

Rev. V1

### Typical Performance Curves

Reference Loss vs. Frequency

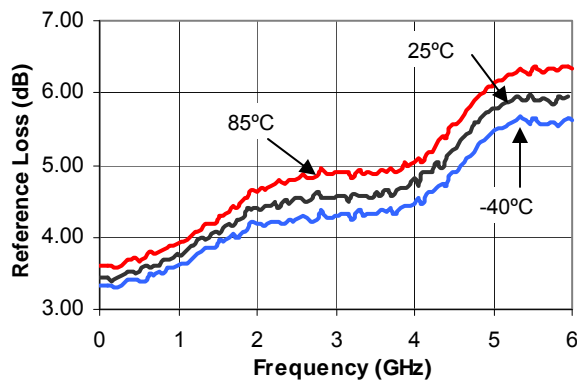

Attenuation - 1 dB Bit vs. Frequency

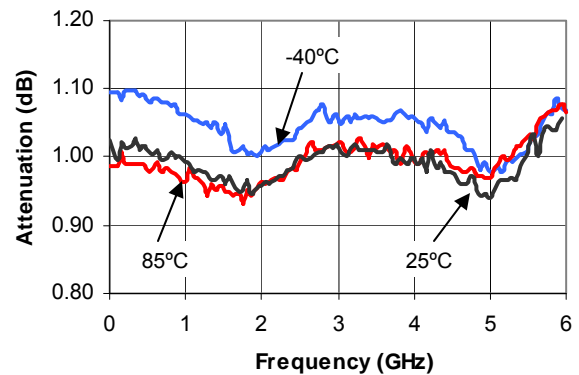

Attenuation - 2 dB Bit vs. Frequency

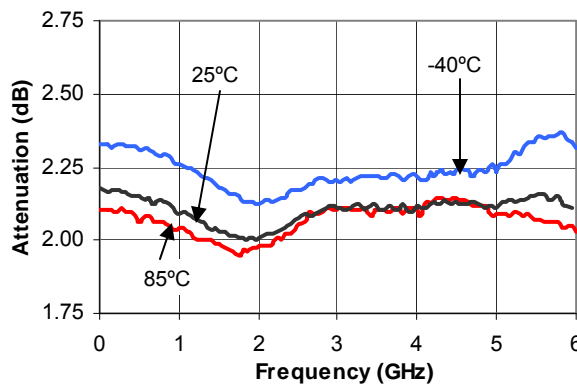

Attenuation - 4 dB Bit vs. Frequency

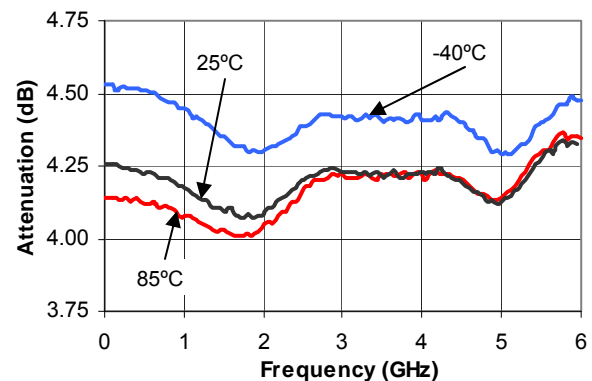

Attenuation - 8 dB Bit vs. Frequency

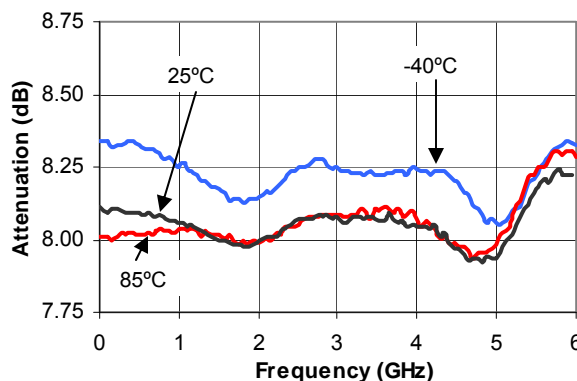

Attenuation - 16 dB Bit vs. Frequency

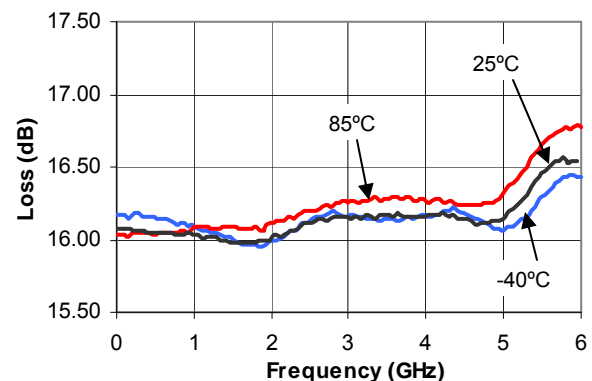

## Constant Phase Digital Attenuator 32 dB, 2-Bit, TTL Driver, DC-3.0 GHz

Rev. V1

### Typical Performance Curves

**Attenuation - 31 dB Attenuation vs. Frequency**

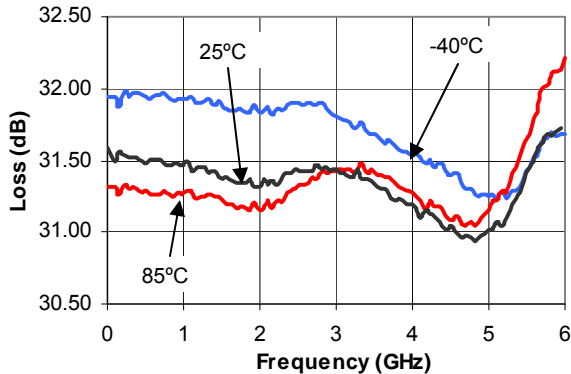

**Phase - 1 dB Bit vs. Frequency  
Relative to Reference Loss State**

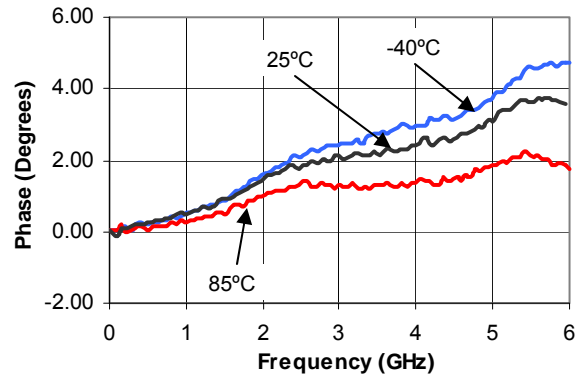

**Phase - 2 dB Bit vs. Frequency  
Relative to Reference Loss State**

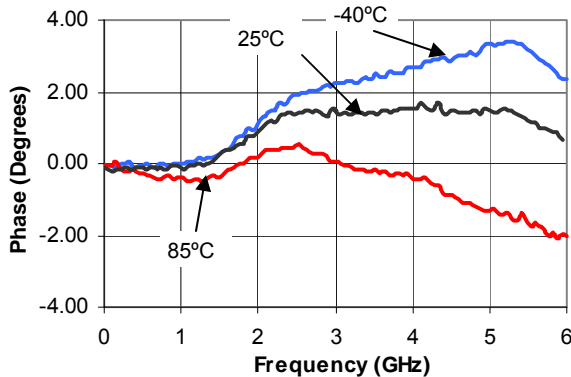

**Phase - 4 dB Bit vs. Frequency  
Relative to Reference Loss State**

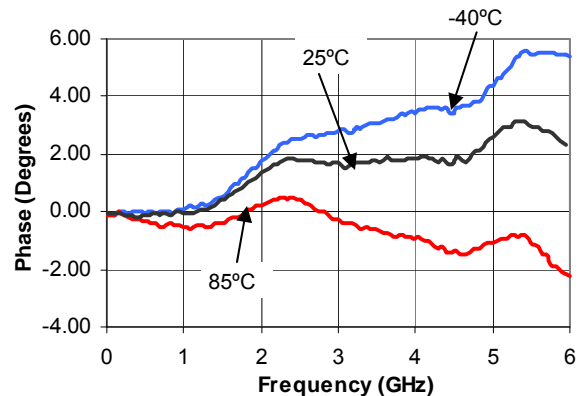

**Phase - 8 dB Bit vs. Frequency  
Relative to Reference Loss State**

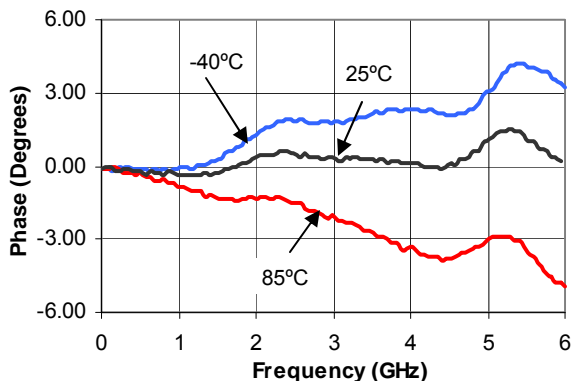

**Phase - 16 dB Bit vs. Frequency  
Relative to Reference Loss State**

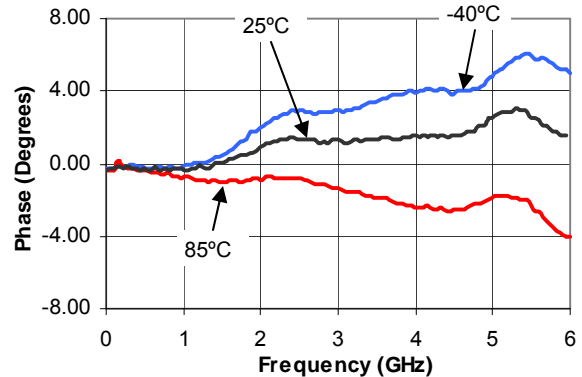

## Typical Performance Curves

**Phase - 31 dB Attenuation vs. Frequency Relative to Reference Loss State**

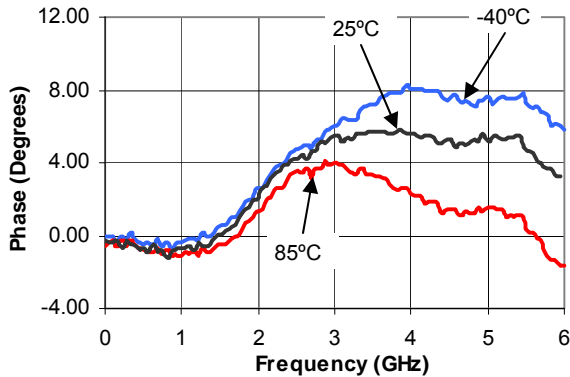

**VSWR - Reference State vs. Frequency**

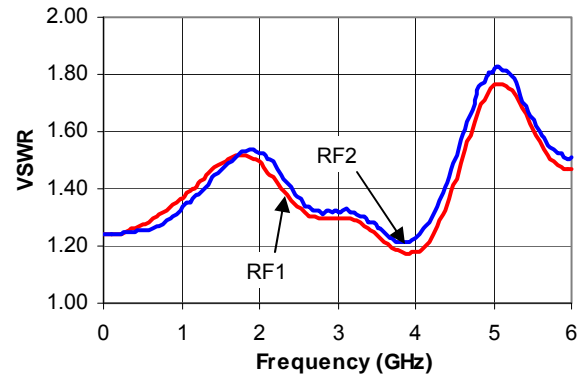

**VSWR - 1 dB Bit vs. Frequency**

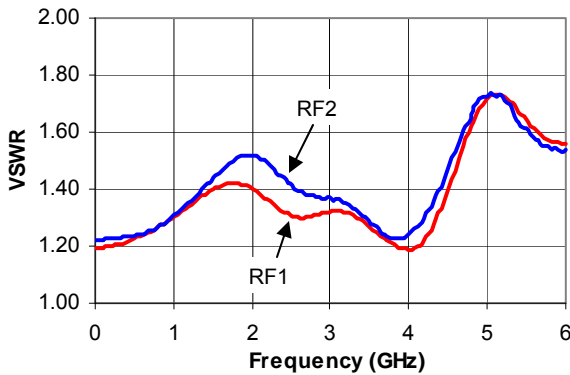

**VSWR - 2 dB Bit vs. Frequency**

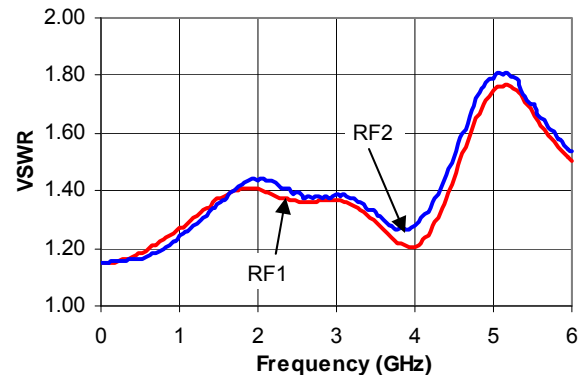

**VSWR - 4 dB Bit vs. Frequency**

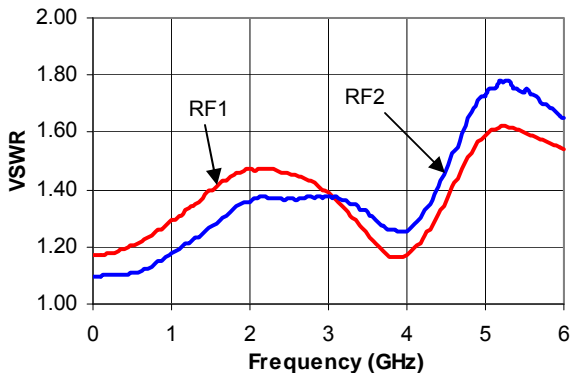

**VSWR - 8 dB Bit vs. Frequency**

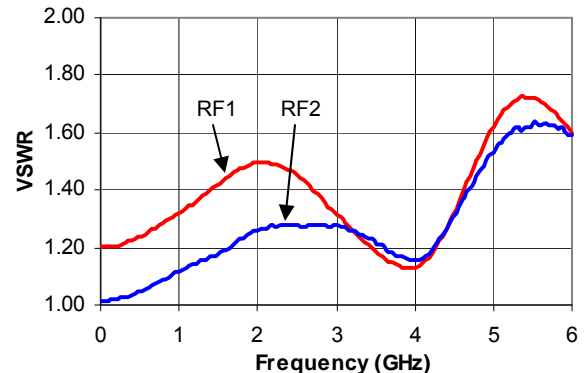

## Typical Performance Curves

VSWR - 16 dB Bit vs. Frequency

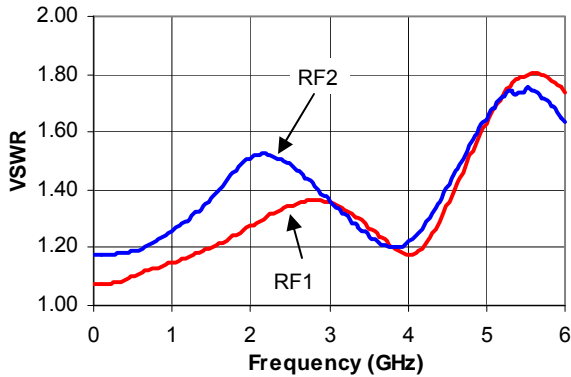

VSWR - 31 dB Attenuation vs. Frequency

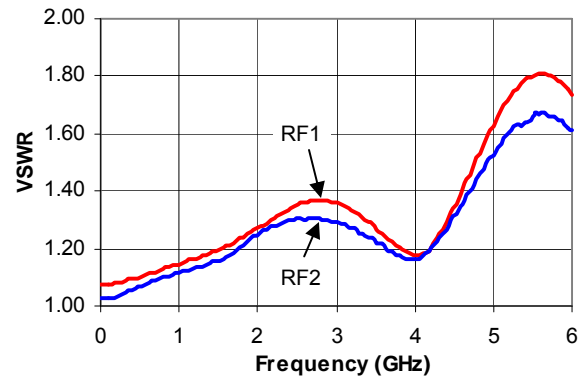

Typical Input IP2 and IP3 at Room Temperature<sup>9</sup>

Attenuation	IP2			IP3			Units
	50 MHz	500 MHz	2 GHz	50 MHz	500 MHz	2 GHz	
Reference State	50	68	70	39	43	42	dBm
1 dB	50	68	70	39	43	37	dBm
2 dB	50	68	70	39	43	37	dBm
4 dB	50	68	70	37	37	37	dBm
8 dB	50	68	70	37	37	37	dBm
16 dB	50	68	65	31	32	32	dBm
31 dB	50	50	50	31	30	29	dBm

9. IP2 and IP3 are measured with two-tone inputs F1 and F2 up to +5 dBm with 1 MHz spacing.

Typical Switching Speed at Room Temperature

Testing Condition	Ton	Trise	Units
Ref. State ↔ 1 dB	3.6	3.6	μs
Ref. State ↔ 2 dB	3.6	3.6	μs
Ref. State ↔ 4 dB	3.7	3.7	μs
Ref. State ↔ 8 dB	3.3	3.3	μs
Ref. State ↔ 16 dB	4.5	4.5	μs
Ref. State ↔ 31 dB	30.5	30.5	μs

## Constant Phase Digital Attenuator 32 dB, 2-Bit, TTL Driver, DC-3.0 GHz

Rev. V1

### CSP-1, 4 x 6 mm, 32-lead PQFN†

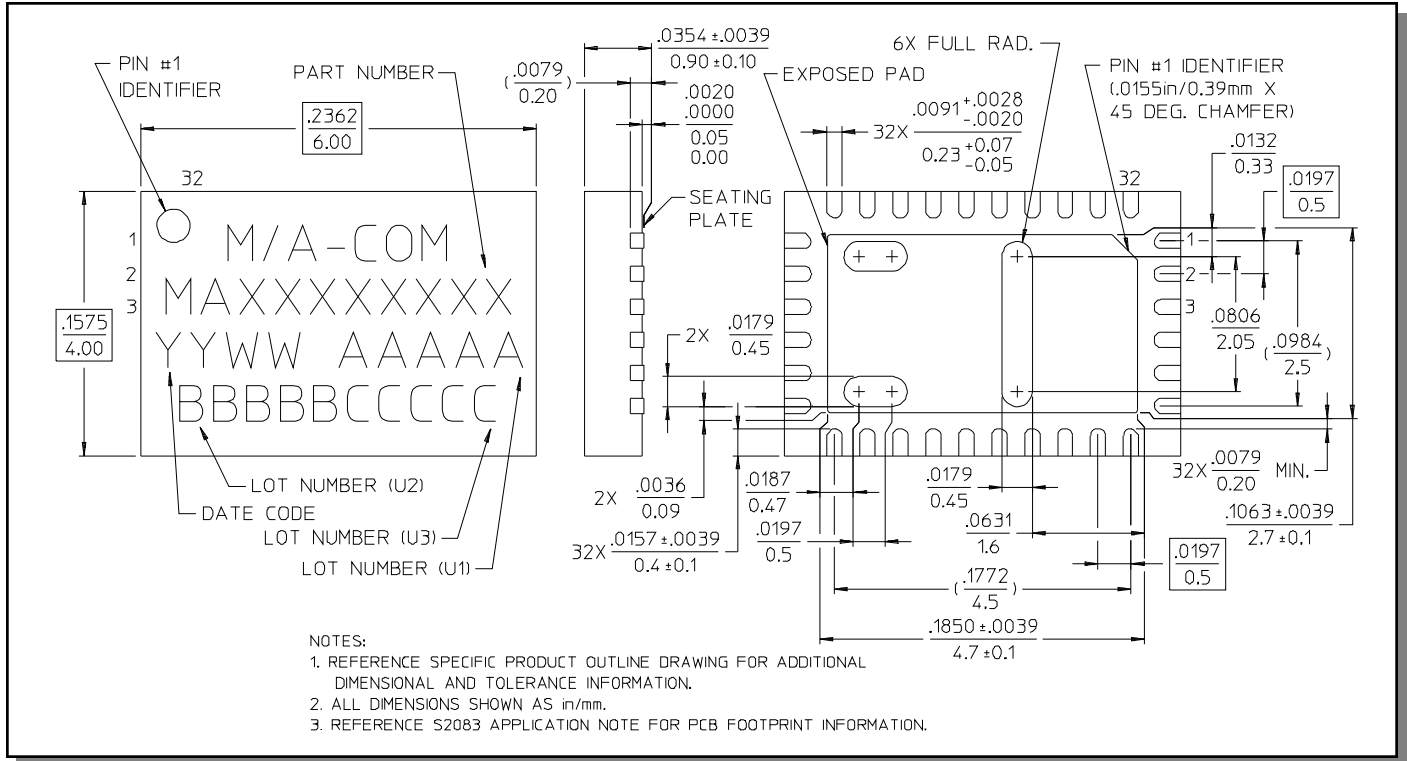

† Reference Application Note M538 for lead-free solder reflow recommendations.