

Single-Phase Full-Wave Motor Driver for Silent Fan Motor

Features

- **Single Phase Full Wave Fan Driver**
- **Silent Driver**
- **Low Supply Current**
- **Low Standby Current (Lock mode T_{OFF} or PWM=0 duty), Supply current less than 220mA**
- **Speed Controllable by PWM Input Signal**
- **Built-in Quick Start Function**
- **Lock Protection and Auto Restart Function**
- **Built-in FG Output**
- **Built-in Thermal Protection Circuit**
- **Lead Free and Green Devices Available (RoHS Compliant)**

General Description

The APX9267 is a single phase full wave motor driver for DC fan motor, and speed controlled by PWM input signal. The output signal of this IC is the amplified hall input signal. It is suitable for both game machine and CPU cooler that need silent drivers. The device is built-in lock protection. When fan is locked, the device will enter the lockup protection mode. It is also with thermal shutdown function. In normal operation, supply current is less than 5mA, but in PWM=0 standby mode, it is just around 150mA. Moreover, this feature will shutdown Amplifier and FG. The APX9267 is available in MSOP-8 package.

Applications

- **Motor Drivers For Silent Fan Motors**

Pin Configuration

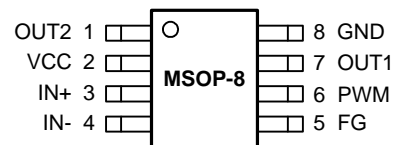

Ordering and Marking Information

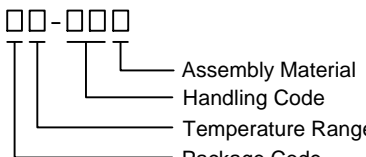
APX9267		Package Code X : MSOP-8 Operating Ambient Temperature Range I : -40 to 105 °C Handling Code TR : Tape & Reel Assembly Material L : Lead Free Device G : Halogen and Lead Free Device
APX9267 X :	<div style="border: 1px solid black; padding: 2px; display: inline-block;"> A9267 XXX XX </div>	XXXXX - Date Code

Note: ANPEC lead-free products contain molding compounds/die attach materials and 100% matte tin plate termination finish, which are fully compliant with RoHS. ANPEC lead-free products meet or exceed the lead-free requirements of IPC/JEDEC J-STD-020C for MSL classification at lead-free peak reflow temperature. ANPEC defines "Green" to mean lead-free (RoHS compliant) and halogen free (Br or Cl does not exceed 900ppm by weight in homogeneous material and total of Br and Cl does not exceed 1500ppm by weight).

Absolute Maximum Ratings (Note 1)

Symbol	Parameter	Rating	Unit
V_{CC}	VCC Pin Supply Voltage	7	V
I_{OUT}	Output Pin Output Current	1	A
V_{OUT}	Output Pin Output Voltage	7	V
V_{FG}	FG Pin Output Voltage	7	V
I_{FG}	FG Pin Sink Current	10	mA

ANPEC reserves the right to make changes to improve reliability or manufacturability without notice, and advise customers to obtain the latest version of relevant information to verify before placing orders.

Absolute Maximum Ratings (Cont.)

Symbol	Parameter	Rating	Unit
$R_{TH,JA}$	Thermal Resistance-Junction to Ambient MSOP-8	225	°C/W
P_D	Power Dissipation	0.585	W
T_J	Junction Temperature	-40 to 150	°C
T_{STG}	Storage Temperature	-65 to 150	°C
T_{SDR}	Maximum Lead Soldering Temperature, 10 Seconds	260	°C

Note 1: Absolute Maximum Ratings are those values beyond which the life of a device may be impaired. Exposure to absolute maximum rating conditions for extended periods may affect device reliability.

Recommended Operating Conditions

Symbol	Parameter	Rating	Unit
V_{CC}	VCC Pin Supply Voltage	2.3 to 5.5	V
V_{Hall}	Hall Input Voltage Range	0.2 to $V_{CC}-1.1$	V
T_A	Ambient Temperature	-40 to 105	°C

Electrical Characteristics ($V_{CC}=5V$, $T_A=25^\circ C$, unless otherwise specified)

Symbol	Parameter	Test Conditions	APX9267			Unit
			Min.	Typ.	Max.	
I_{CC1}	Operating Current	Rotation Mode	-	3	5	mA
I_{CC2}	Standby Supply Current	Lock Protect T_{OFF} or PWM=0	-	150	220	μA
V_{PWMH}	PWM Input High Level Voltage		2.5	-	$V_{CC}+0.5$	V
V_{PWML}	PWM Input Low Level Voltage		0	-	1	V
F_{PWM}	PWM Input Frequency		0.02	-	50	kHz
V_{HOFS}	Input Offset Voltage		-	-	± 6	mV
G_{IO}	Input-Output Gain	$V_{OUT}/H+-H-$ (ratio)	45	48	51	dB
V_{OL}	Output Lower Side Saturation	$I_{OUT}=250mA$	-	0.15	0.22	V
V_{OH}	Output Upper Side Saturation	$I_{OUT}=250mA$	-	0.15	0.22	V
V_{FG}	FG Pin Low Voltage	$I_{FG}=3mA$	-	0.2	0.3	V
I_{FG}	FG Pin Leak Current	$V_{FG}=5V$	-	-	10	μA
	Over Temperature Shutdown		-	170	-	°C
	Over Temperature Shutdown Hysteresis		-	35	-	
T_{QS}	Quick Start Enable Time		-	66.5	90	mSec

Typical Operating Characteristics

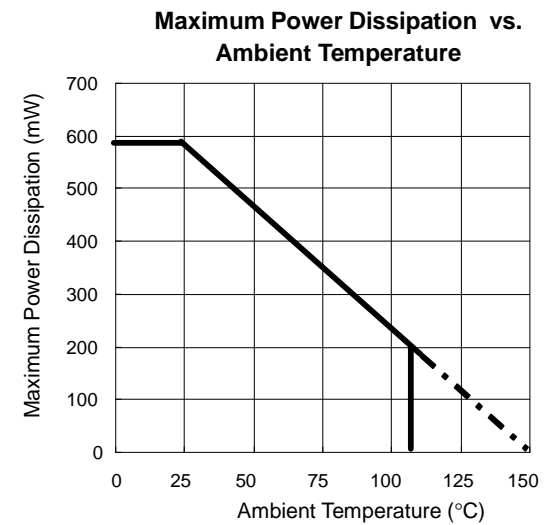
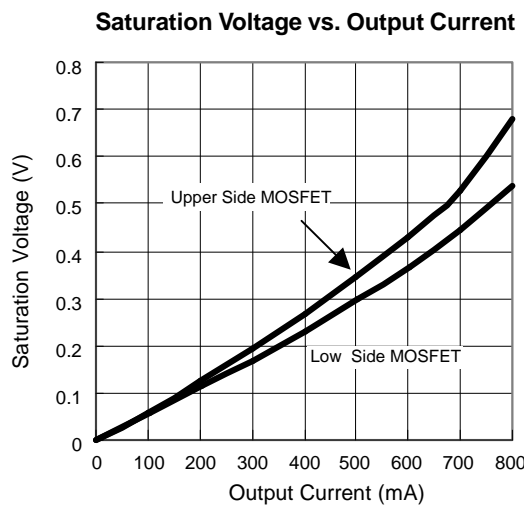
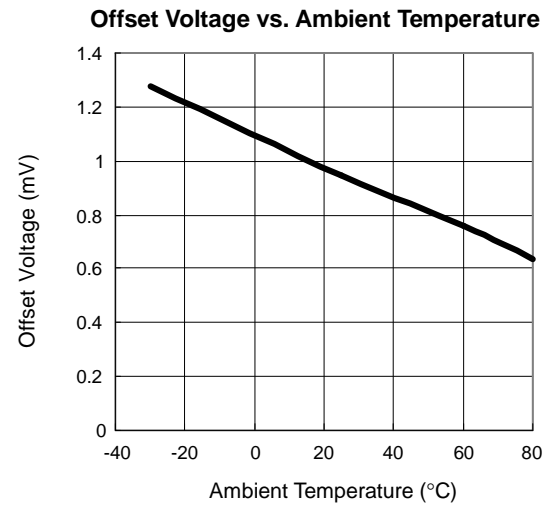
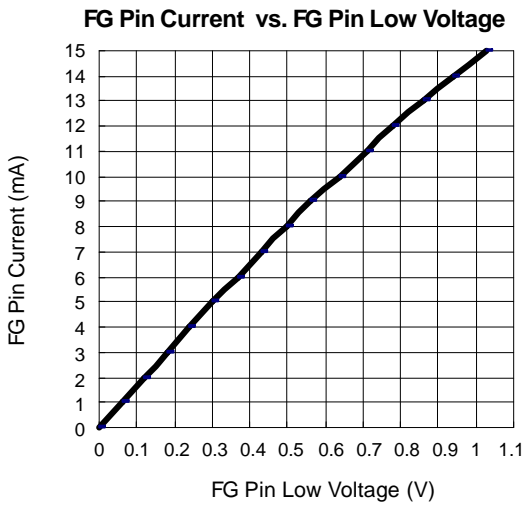
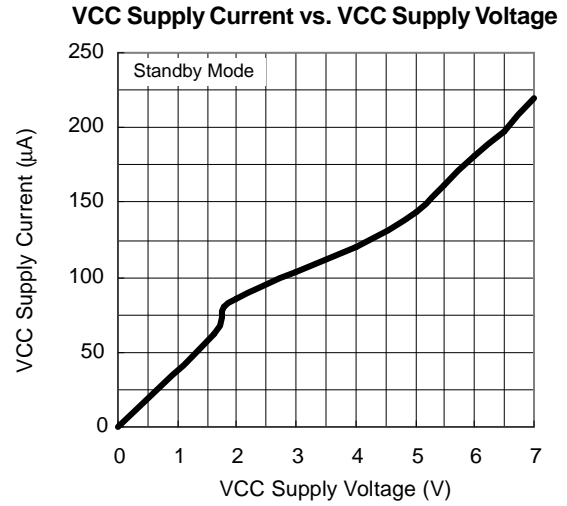
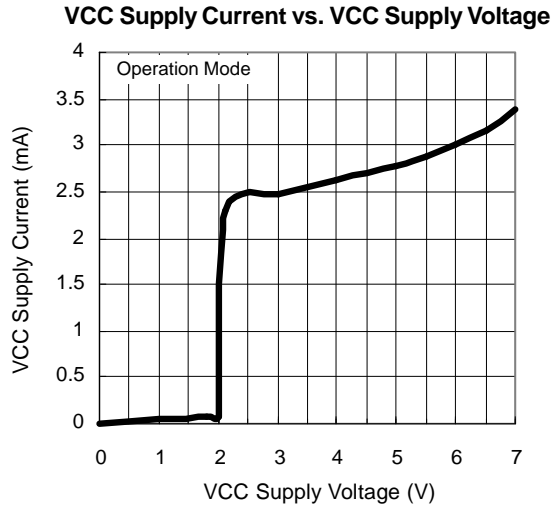

Operating Waveforms

Rotation Waveform 1

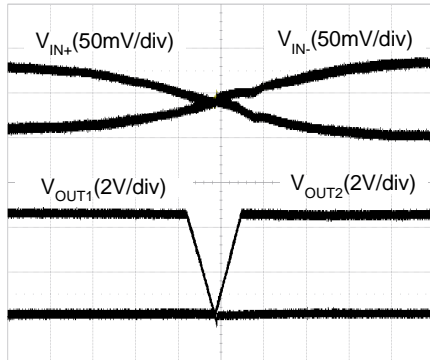

Time (0.2ms/div)

Rotation Waveform 2

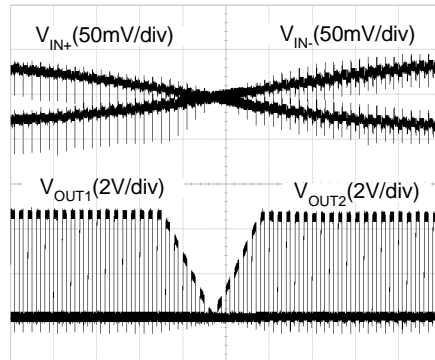

Time (0.2ms/div)

Rotation Waveform 3

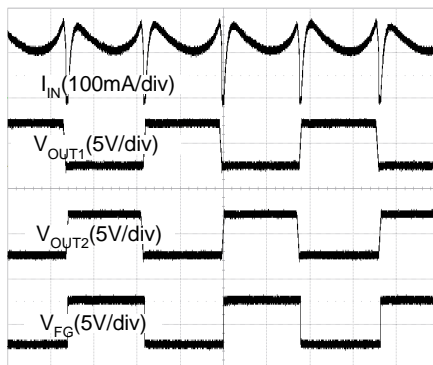

Time (2ms/div)

Rotation Waveform 4

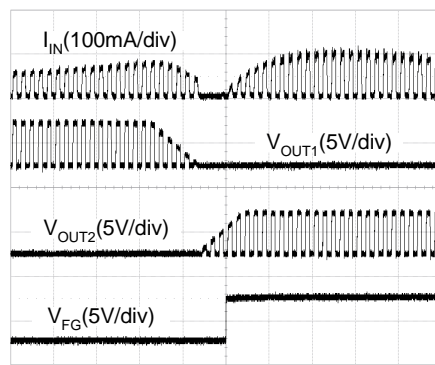

Time (0.2ms/div)

Lock Protection Waveform 1

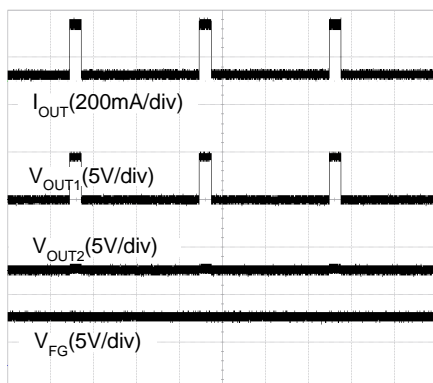

Time (2s/div)

Lock Protection Waveform 2

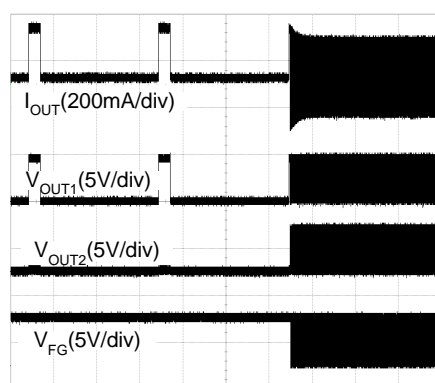

Time (2s/div)

Pin Description

PIN		Description
No.	Name	
1	OUT2	H-bridge Output Connection. The output stage is a H-bridge formed by four transistors and four-protection diode for switching applications.
2	VCC	Supply Voltage Input Pin.
3	IN+	Hall Input +.
4	IN-	Hall Input -.
5	FG	Rotation Speed Output.
6	PWM	PWM Signal Input Terminal.
7	OUT1	H-bridge Output Connection. The output stage is a H-bridge formed by four transistors and four-protection diode for switching applications.
8	GND	Ground.

Block Diagram

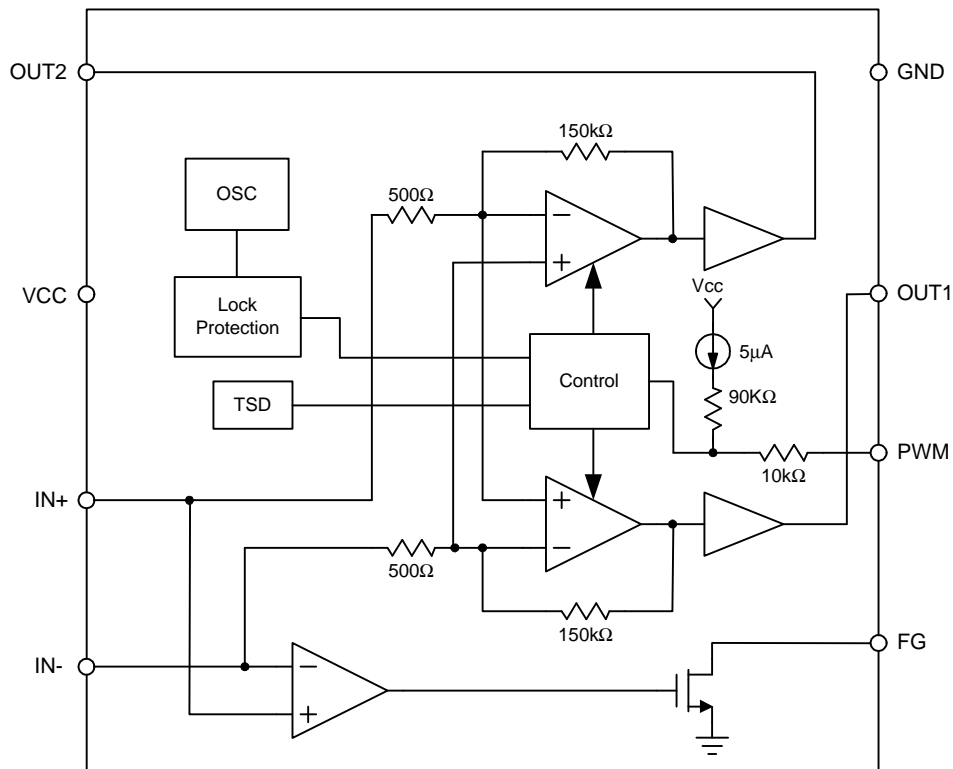

Typical Application Circuit

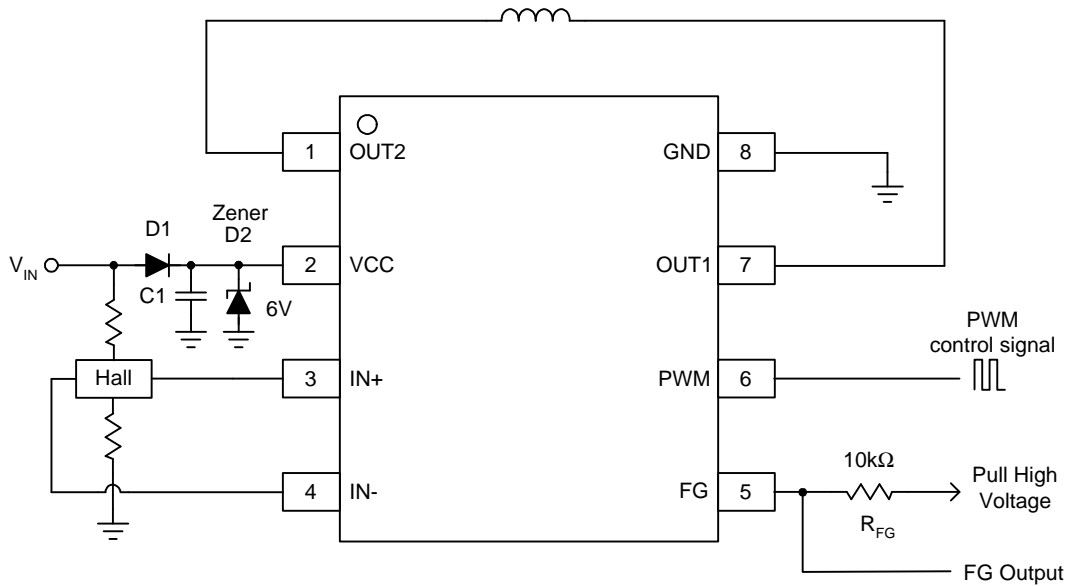

Note 2: In hot plug application, it's necessary to protect against a hot plug input voltage overshoot. Add an input zener diode, between the VCC and GND, to clamp the overshoot. In normal operation diode, the zener diode isn't stressed because output current doesn't reverse to VCC.

Function Description

Lockup Protection and Automatic Restart

This IC detects the rotation of the motor by hall signal, and adjusts lock detection ON time (T_{ON}) and lock detection OFF time (T_{OFF}) by internal counter. These times (T_{ON} , T_{OFF}) are showed below.

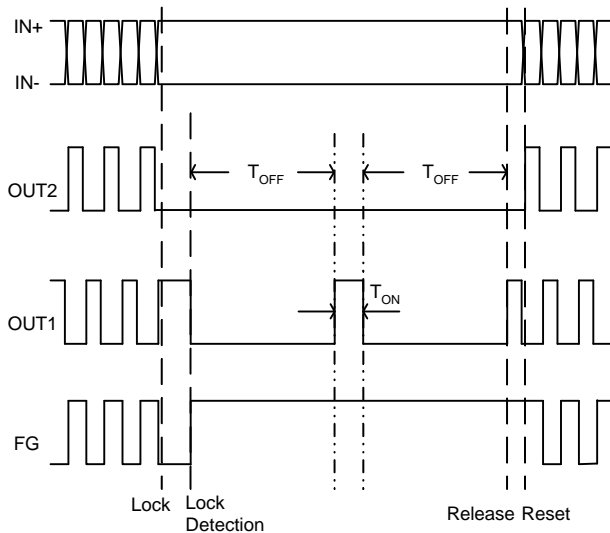

Figure 1. Lock Protection and Automatic Protection Waveform

Quick Start and Standby mode

This IC would enter standby mode when the PWM input keeps low level for more than 66.5ms (typ.). In standby mode, it will shutdown amplifier and FG. Thus, the supply current is around 150μA. In standby mode, the lock protection function doesn't work, therefore, starting fan is unobstructed when releasing standby mode.

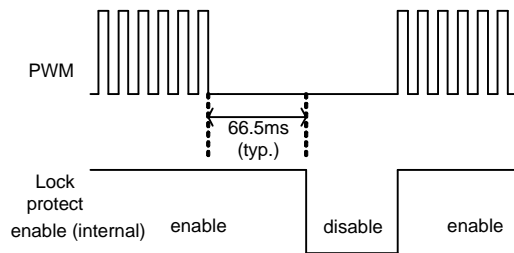

Figure 2. Quick Start Waveform

Frequency Generator Function

The FG pin is an open collector output, connecting a pull up resistor to a high level voltage for the frequency gen-

Function Description (Cont.)

Frequency Generator Function (Cont.)

erator function. During the Lock Mode, the FG will be always high (switch off) (See Truth Table). Open the terminal when not in using.

Thermal Protection

The APX9267 has thermal protection, when internal

junction temperature reaches 170°C, the output devices will be switched off. When the IC's junction temperature cools by 35°C, the thermal sensor will turn the output devices on again, resulting in a pulsed output during continuous thermal protection.

Truth Table

Input			Output			Mode
IN-	IN+	PWM	OUT1	OUT2	FG	
L	H	H	H	L	L	Operation Mode
H	L		L	H	OFF	
H	L	L	L	L	OFF	
L	H		L	L	L	
L	H	-	L	L	OFF	Lock Mode
H	L		L	L	OFF	
-	-	L	OFF	OFF	OFF	Standby Mode

Application Information

Input Protection Diode & Capacitor

The APX9267 should be added a protection diode (D1) to protect the damage from the power reverse connection. However, the protection diode will cause a voltage drop on the supply voltage. The current rating of the diode must be greater than the maximum output current. For the noise reduction purpose, a capacitor (C1) 1μF is connected between VCC and GND (See Typical Application Circuit).

Hall input

Please adjust hall input voltage by value of resistance so that hall signal contains amplitude input within range $GND \sim V_{CC} - 1.1$.

The output signal of this IC is the amplified hall input signal, therefore, the output signal depends on hall input. When the hall input is small, the output signal becomes gentle. Oppositely, when the input signal is large, the output becomes steep (See Figure 3. Differences of output signal depending on the shape of hall input signal). The input/output gain is 48dB (typ.). Thus, please adjust the amplitude of hall input to meet the adequate output voltage.

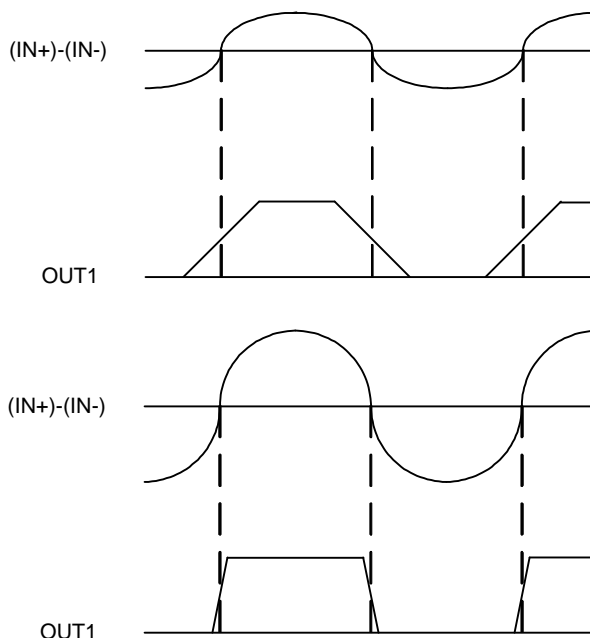

Figure 3. Differences of Output Signal Depending on the Shape of Hall Input Signal

Application Information (Cont.)

PWM input

It is possible to change rotation speed of the motor by switching high side output transistor. The on-duty of switching depends on the input signal to PWM terminal. (See Figure 4. PWM Input Waveform)

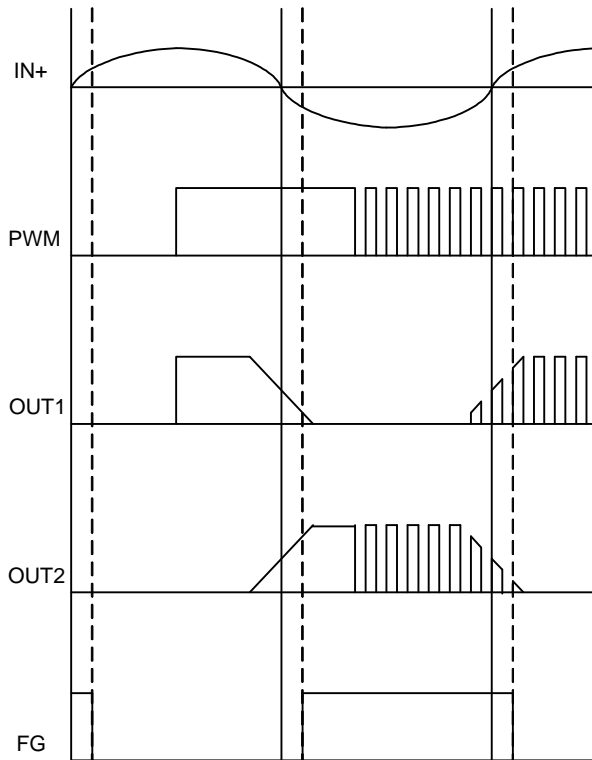

Figure 4. PWM Input Waveform

The input level of PWM terminal is

H : High side output transistor is ON

L : High side output transistor is OFF

When PWM terminal is open, it is equal to H.

FG Resistor

The value of the FG resistor could be decided by the following equation:

$$R_{FG} = \frac{V_{CC} - V_{FG}}{I_{FG}}$$

For example:

$$V_{CC} = 5V, I_{FG} = 3mA, V_{FG} = 0.2V, R_{FG} = 1.6k\Omega$$

The value of resistor in the range of 1k Ω to 10k Ω is recommended.

Thermal Consideration

Refer to “Maximum Power Dissipation vs. Ambient Temperature”, the IC is safe to operate below the curve and it will cause the thermal protection if the operating area is above the line. For example, $T_A = 75^\circ C$, the maximum power dissipation is about 0.35W.

The power dissipation can be calculated by the following equation:

$$P_D = (V_{CC} - |V_{OUT1} - V_{OUT2}|) \times I_{OUT} + V_{CC} \times I_{CC}$$

For example:

$$V_{CC} = 5V, I_{CC} = 4mA, I_{OUT} = 270mA, V_{OUT1} = 4.83V,$$

$$V_{OUT2} = 0.17V, \text{ then } P_D = 0.111W$$

The GND pin provides an electrical connection to ground and channeling heat away. The printed circuit board (PCB) forms a heat sink and dissipates most of the heat into ambient air.

Package Information

MSOP-8

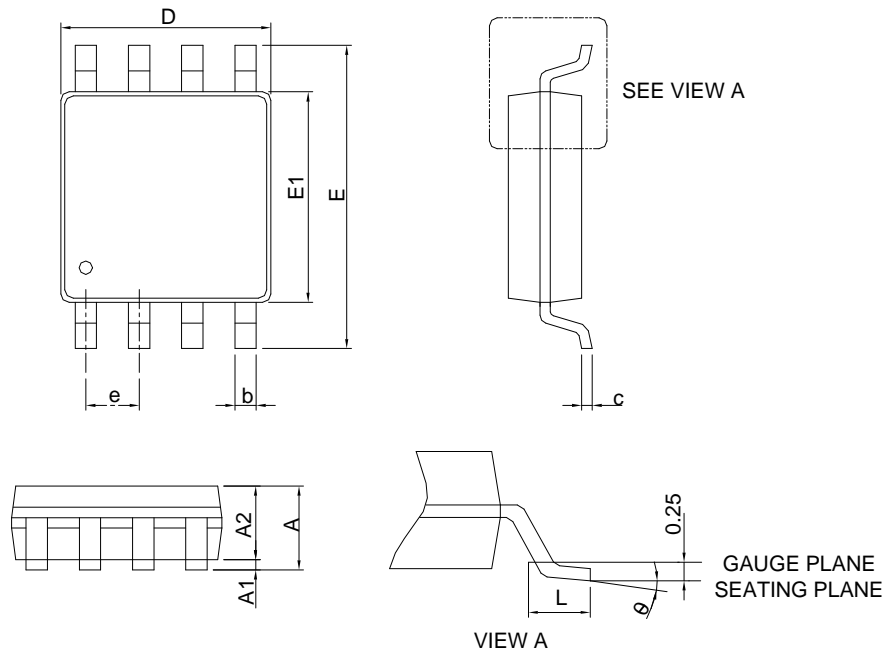

SYMBOL	MSOP-8			
	MILLIMETERS		INCHES	
	MIN.	MAX.	MIN.	MAX.
A		1.10		0.043
A1	0.00	0.15	0.000	0.006
A2	0.75	0.95	0.030	0.037
b	0.22	0.38	0.009	0.015
c	0.08	0.23	0.003	0.009
D	2.90	3.10	0.114	0.122
E	4.70	5.10	0.185	0.201
E1	2.90	3.10	0.114	0.122
e	0.65 BSC		0.026 BSC	
L	0.40	0.80	0.016	0.031
θ	0°	8°	0°	8°

- Note: 1. Follow JEDEC MO-187 AA.
 2. Dimension " D " does not include mold flash, protrusions or gate burrs. Mold flash, protrusion or gate burrs shall not exceed 6 mil per side.
 3. Dimension " E1 " does not include inter-lead flash or protrusions. Inter-lead flash and protrusions shall not exceed 5 mil per side.

Carrier Tape & Reel Dimensions

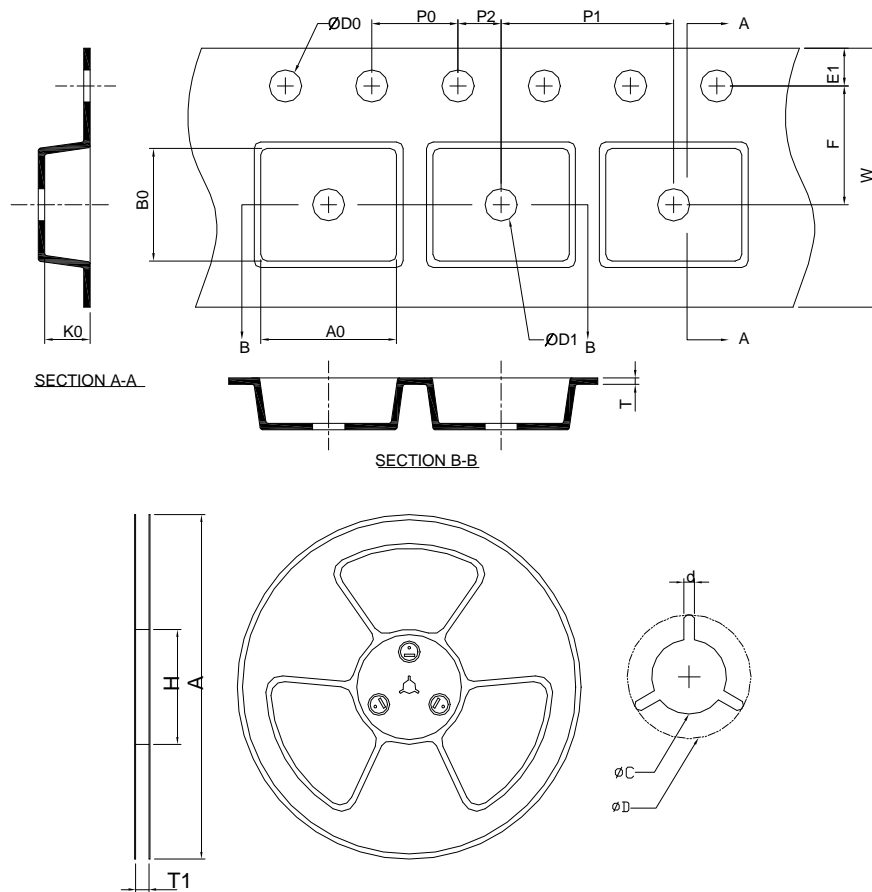

Application	A	H	T1	C	d	D	W	E1	F
MSOP- 8	330.0 ±2.00	50 MIN.	12.4+2.00 -0.00	13.0+0.50 -0.20	1.5 MIN.	20.2 MIN.	12.0 ±0.30	1.75 ±0.10	5.5 ±0.10
	P0	P1	P2	D0	D1	T	A0	B0	K0
	4.00 ±0.10	8.00 ±0.10	2.00 ±0.10	1.5+0.10 -0.00	1.5 MIN.	0.6+0.00 -0.40	6.70 ±0.20	3.30 ±0.20	1.40 ±0.20

(mm)

Devices Per Unit

Package Type	Unit	Quantity
MSOP- 8	Tape & Reel	3000

Reflow Condition (IR/Convection or VPR Reflow)

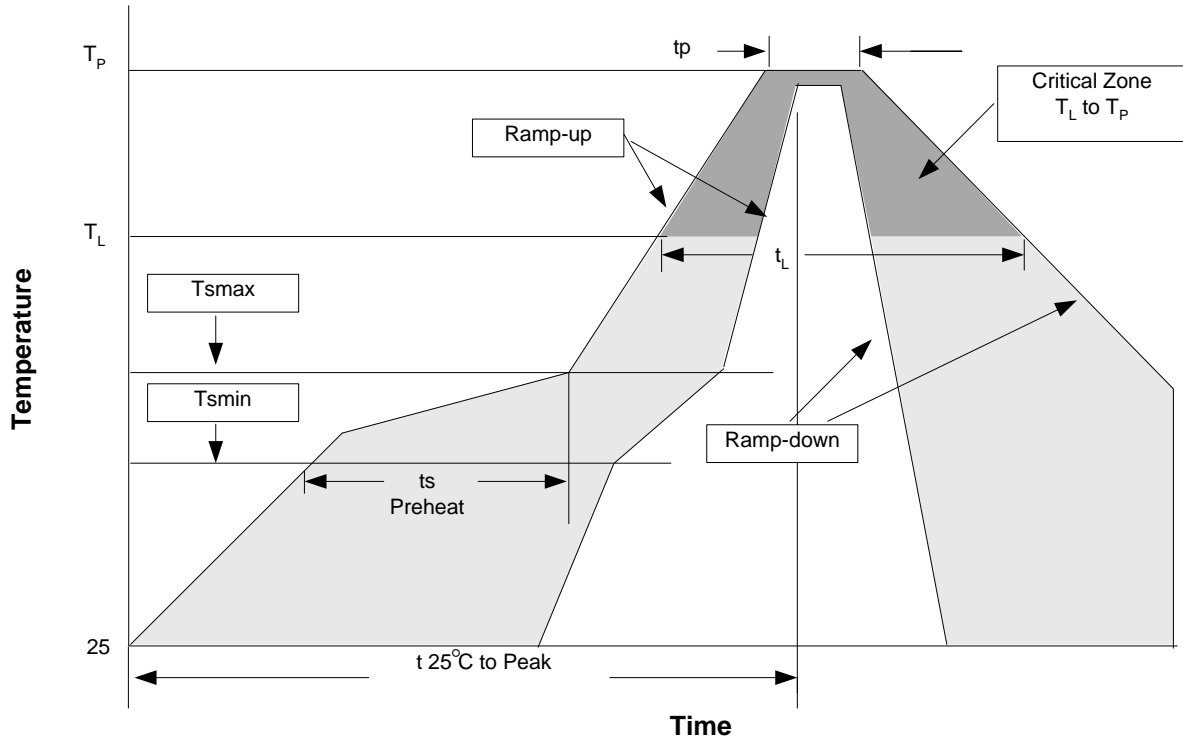

Reliability Test Program

Test item	Method	Description
SOLDERABILITY	MIL-STD-883D-2003	245°C, 5 sec
HOLT	MIL-STD-883D-1005.7	1000 Hrs Bias @125°C
PCT	JESD-22-B,A102	168 Hrs, 100%RH, 121°C
TST	MIL-STD-883D-1011.9	-65°C~150°C, 200 Cycles
ESD	MIL-STD-883D-3015.7	VHBM > 2KV, VMM > 200V
Latch-Up	JESD 78	10ms, $I_{tr} > 100mA$

Classification Reflow Profiles

Profile Feature	Sn-Pb Eutectic Assembly	Pb-Free Assembly
Average ramp-up rate (T _L to T _P)	3°C/second max.	3°C/second max.
Preheat		
- Temperature Min (T _{smin})	100°C	150°C
- Temperature Max (T _{smax})	150°C	200°C
- Time (min to max) (t _s)	60-120 seconds	60-180 seconds
Time maintained above:		
- Temperature (T _L)	183°C	217°C
- Time (t _L)	60-150 seconds	60-150 seconds
Peak/Classification Temperature (T _P)	See table 1	See table 2
Time within 5°C of actual Peak Temperature (t _p)	10-30 seconds	20-40 seconds
Ramp-down Rate	6°C/second max.	6°C/second max.
Time 25°C to Peak Temperature	6 minutes max.	8 minutes max.

Note: All temperatures refer to topside of the package. Measured on the body surface.

Classification Reflow Profiles (Cont.)

Table 1. SnPb Eutectic Process – Package Peak Reflow Temperatures

Package Thickness	Volume mm ³ <350	Volume mm ³ ≥350
<2.5 mm	240 +0/-5°C	225 +0/-5°C
≥2.5 mm	225 +0/-5°C	225 +0/-5°C

Table 2. Pb-free Process – Package Classification Reflow Temperatures

Package Thickness	Volume mm ³ <350	Volume mm ³ 350-2000	Volume mm ³ >2000
<1.6 mm	260 +0°C*	260 +0°C*	260 +0°C*
1.6 mm – 2.5 mm	260 +0°C*	250 +0°C*	245 +0°C*
≥2.5 mm	250 +0°C*	245 +0°C*	245 +0°C*

* Tolerance: The device manufacturer/supplier **shall** assure process compatibility up to and including the stated classification temperature (this means Peak reflow temperature +0°C. For example 260°C+0°C) at the rated MSL level.

Customer Service

Anpec Electronics Corp.

Head Office :

No.6, Dusing 1st Road, SBIP,
Hsin-Chu, Taiwan, R.O.C.
Tel : 886-3-5642000
Fax : 886-3-5642050

Taipei Branch :

2F, No. 11, Lane 218, Sec 2 Jhongsing Rd.,
Sindian City, Taipei County 23146, Taiwan
Tel : 886-2-2910-3838
Fax : 886-2-2917-3838