

1N4933G THRU 1N4937G

CURRENT 1.0 Ampere
VOLTAGE 50 to 600 Volts

Features

- Fast switching
- Low leakage current
- Low forward voltage drop
- High current capability
- Glass passivated junction
- High reliability capability

Mechanical Data

- Case : JEDEC DO-41 molded plastic body
- Terminals : Plated axial lead solderable per MIL-STD-750, method 2026
- Polarity : Color band denotes cathode end
- Mounting Position : Any
- Weight : 0.012 ounce, 0.34 gram

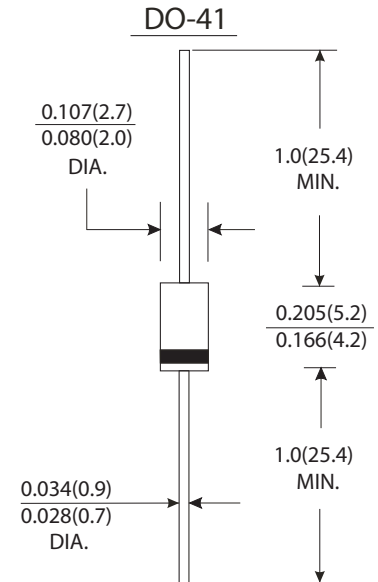

Dimensions in inches and (millimeters)

Maximum Ratings And Electrical Characteristics

(Ratings at 25 °C ambient temperature unless otherwise specified, Single phase, half wave 60Hz, resistive or inductive load. For capacitive load, derate by 20%)

	Symbols	1N4933G	1N4934G	1N4935G	1N4936G	1N4937G	Units
Maximum recurrent peak reverse voltage	V _{RRM}	50	100	200	400	600	Volts
Maximum RMS voltage	V _{RMS}	35	70	140	280	420	Volts
Maximum DC blocking voltage	V _{DC}	50	100	200	400	600	Volts
Maximum average forward rectified current 0.375"(9.5mm) lead length at T _A =75 °C	I _(AV)	1.0					Amp
Peak forward surge current 8.3ms single half sine-wave superimposed on rated load (JEDEC method) at T _A =55 °C	I _{FSM}	30.0					Amps
Maximum instantaneous forward voltage at 1.0A	V _F	1.2					Volts
Maximum DC reverse current at rated DC blocking voltage	I _R	5.0					μA
Maximum full load reverse current full cycle average. 0.375"(9.5mm) lead length at T _L =55 °C		100					
Maximum reverse recovery time (Note 1)	T _{rr}	150					ns
Typical junction capacitance (Note 2)	C _J	15.0					pF
Operating junction and storage temperature range	T _J T _{STG}	-65 to +175					°C

Notes:

- (1) Test conditions: I_F=1.0A, V_R=30V
- (2) Measured at 1MHz and applied reverse voltage of 4.0 Volts.

RATINGS AND CHARACTERISTIC CURVES 1N4933G THRU 1N4937G

FIG.1-TYPICAL FORWARD CURRENT DERATING CURVE

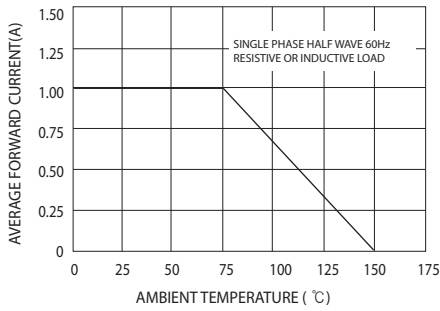

FIG.2-MAXIMUM NON-REPETITIVE FORWARD SURGE CURRENT

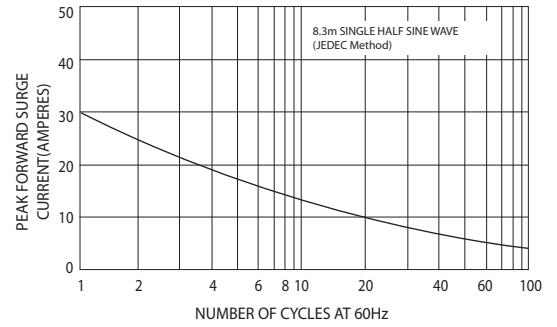

FIG.3-TYPICAL JUNCTION CAPACITANCE

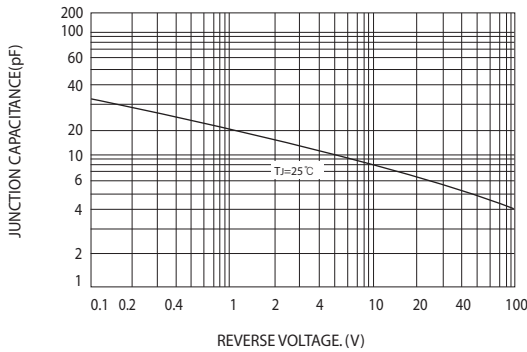

FIG.4-TYPICAL INSTANTANEOUS FORWARD CHARACTERISTICS

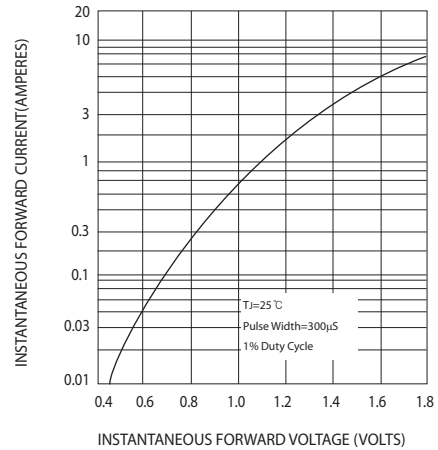
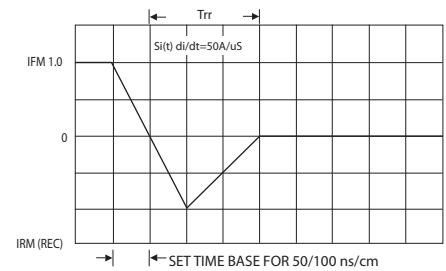
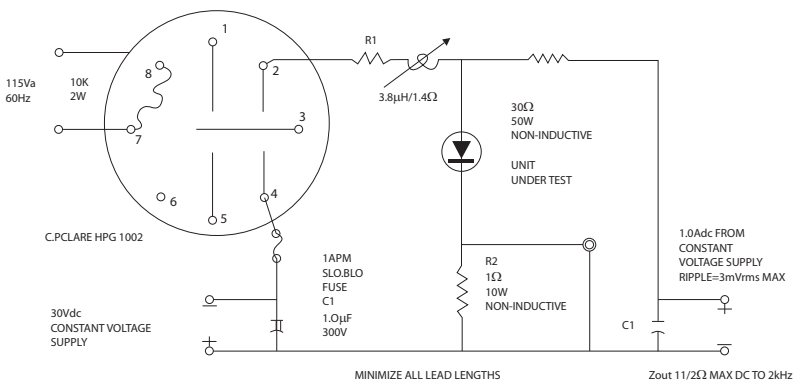

FIG.5-TEST CIRCUIT DIAGRAM AND REVERSE RECOVERY TIME CHARACTERISTIC



A TEKTRONIX 545A,K PLUG IN PRE AMP P6000 PROBE OR EQUIVALENT R1-ADJUSTED FOR 1.45Ω BETWEEN POINT 2 OF RELAY AND RECTIFIER INDUCTIVE=3.8µH
R2-TEN-1W 10% CARBON CORE IN PARALLEL TA=25 +10 °C -0 °C FOR RECTIFIER