



## THIS SPEC IS OBSOLETE

Spec No: 38-07333

Spec Title: CY22K7 133-MHz Spread Spectrum Clock Generator  
For Use With the AMD-K7® Processor and AMD-750  
Chipset

Sunset Owner: Rose Galindez (RGL)

Replaced by: None



CYPRESS

CY22K7

# 133-MHz Spread Spectrum Clock Generator For Use With the AMD-K7<sup>®</sup> Processor and AMD-750 Chipset

Features	Benefits
<ul style="list-style-type: none"> <li>• Multiple output clocks running at different frequencies               <ul style="list-style-type: none"> <li>— Three open-drain differential CPU outputs running up to 133 MHz</li> <li>— Eight 3.3V synchronous PCI clocks (one free running)</li> <li>— Two 3.3V AGP clocks at 2xPCI</li> <li>— One dedicated 3.3V USB clock at 48 MHz</li> <li>— One 3.3V USB/IO clock at 48 MHz or 24 MHz, selectable via power-on latch input</li> <li>— One 3.3V SDRAM clock output running at the CPU frequency</li> <li>— Two 3.3V Reference clocks at 14.318 MHz</li> </ul> </li> </ul>	<p>Main clock generator for PC motherboard designs using the AMD-K7<sup>®</sup> processor and AMD-750 Chipset</p> <ul style="list-style-type: none"> <li>— Supports up to two CPUs and chipset</li> <li>— Support for 4 PCI slots and chipset</li> <li>— Supports designs using AGP</li> <li>— Supports designs using USB</li> <li>— Allows for one additional USB output or support for I/O chip from various vendors</li> <li>— Supports SDRAM memory architecture with external PLL buffer</li> <li>— Supports ISA slots and I/O chip</li> </ul>
<ul style="list-style-type: none"> <li>• Spread Spectrum clocking               <ul style="list-style-type: none"> <li>— 33 kHz modulation frequency</li> <li>— -0.6% downspread margin</li> </ul> </li> </ul>	EMI reduction
<ul style="list-style-type: none"> <li>• Dedicated inputs for various functions               <ul style="list-style-type: none"> <li>— <u>PCI_STOP</u></li> <li>— <u>CPU_STOP</u></li> <li>— <u>PWR_DWN</u></li> <li>— <u>SPREAD</u></li> <li>— <u>TEST</u></li> <li>— <u>USB/IO</u></li> <li>— <u>FS [0:1]</u></li> </ul> </li> </ul>	<p>Provides system design flexibility and power management</p> <ul style="list-style-type: none"> <li>— Stops all PCI clocks (except PCICLK_F0) when LOW</li> <li>— Stops all CPU clocks when LOW</li> <li>— Power is removed from internal logic when LOW</li> <li>— Activates Spread Spectrum for lower EMI</li> <li>— Used to enter Test Mode</li> <li>— Selects USB or SuperIO Clock</li> <li>— Power-on latched inputs for frequency select options</li> </ul>
<ul style="list-style-type: none"> <li>• Serial Programming Interface</li> </ul>	Dynamic control of output clock signals via SMBus
<ul style="list-style-type: none"> <li>• 48-Pin SSOP package</li> </ul>	Industry-standard package provides cost and space savings

## Logic Block Diagram

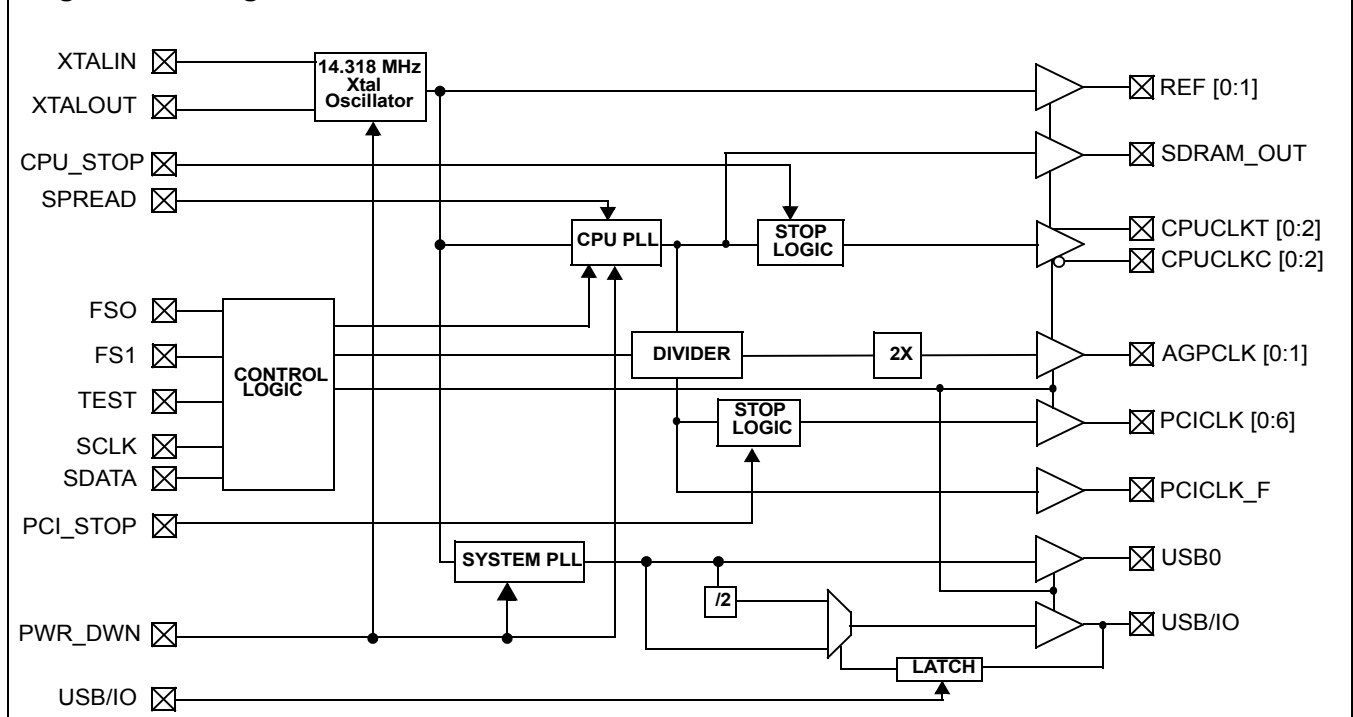

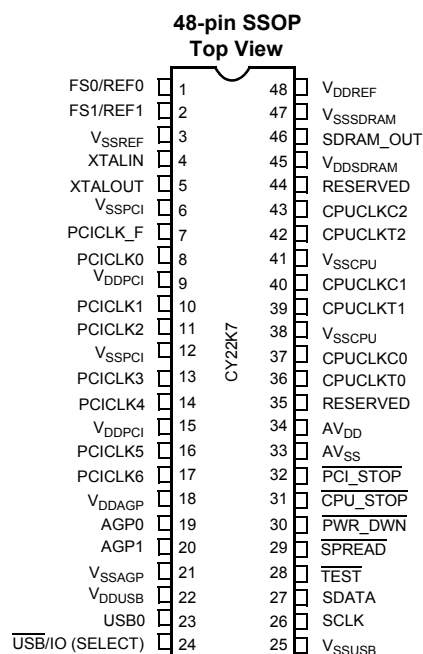
**Pin Configuration**

**Pin Summary<sup>[1]</sup>**

Pin Number	Pin Name	Type	Description
34	AV <sub>DD</sub>	PWR	Isolated power for core
33	AV <sub>SS</sub>	PWR	Isolated ground for core
48	V <sub>DDREF</sub>	PWR	Power for REF[0:1], XTALIN, XTALOUT
3	V <sub>SSREF</sub>	PWR	Ground for REF[0:1] outputs
1, 2	FS[0:1]/REF[0:1]	IN/OUT	Frequency select input at power-on/14.318-MHz output
4	XTALIN <sup>[2]</sup>	IN	14.318-MHz reference crystal input
5	XTALOUT	OUT	14.318-MHz reference crystal feedback
9, 15	V <sub>DDPCI</sub>	PWR	Power for PCICLK outputs
6, 12	V <sub>SSPCI</sub>	PWR	Ground for PCICLK outputs
7	PCICLK_F	OUT	Free running PCI output
8, 10, 11, 13, 14, 16, 17	PCICLK[0:6]	OUT	PCI clock outputs, TTL compatible 3.3V
18	V <sub>DDAGP</sub>	PWR	Power for AGP outputs
21	V <sub>SSAGP</sub>	PWR	Ground for AGP outputs
19, 20	AGP[0:1]	OUT	AGP clock outputs
22	V <sub>DDUSB</sub>	PWR	Power for USB outputs
25	V <sub>SSUSB</sub>	PWR	Ground for USB outputs
23	USB0	OUT	USB clock output
24	USB/I/O (SELECT)	IN/OUT	USB or Super I/O output selected at power-on by latched input resistor: LOW = 48 MHz, HIGH = 24 MHz
26	SCLK	IN/OUT	SMBus Clock
27	SDATA	IN/OUT	SMBus Data
28	TEST	IN	Three-state or Test Mode when LOW

**Pin Summary**<sup>[1]</sup> (continued)

Pin Number	Pin Name	Type	Description
29	SPREAD	IN	Enables spread spectrum when LOW
30	PWR_DWN <sup>[3]</sup>	IN	Power-down when LOW, removes power from internal logic
31	CPU_STOP	IN	Stops CPU clocks when LOW
32	PCI_STOP <sup>[2]</sup>	IN	Stops PCI clocks when LOW
45	V <sub>DD</sub> SDRAM	PWR	Power for SDRAM_OUT
47	V <sub>SS</sub> SDRAM	PWR	Ground for SDRAM_OUT
46	SDRAM_OUT	OUT	CPU reference clock for SDRAM zero delay buffer
38, 41	V <sub>SS</sub> CPU	PWR	Ground for CPU outputs shorted to SDRAM ground
36, 39, 42	CPUCLKT[0:2]	OUT	“True” clocks of differential pair for CPU and host clock outputs
37, 40, 43	CPUCLKC[0:2]	OUT	“Complementary” clocks of differential pair for CPU and host clock outputs
35, 44	RESERVED	–	Reserved for future CPU power rail

**Function Table**

TEST	FS1	FS0	CPUCLK SDRAM_OUT	PCICLK PCICLK_F	AGP	USB/IO	REF
0	0	0	Hi-Z	Hi-Z	Hi-Z	Hi-Z	Hi-Z
0	0	1	50	25	50	48/24	14.318
0	1	0	66	33	66	48/24	14.318
0	1	1	TCLK/2	TCLK/6	TCLK/3	TCLK/4 <sup>[4]</sup>	TCLK
1	0	0	90	30	60	48/24	14.318
1	0	1	133	33.3	66.6	48/24	14.318
1	1	0	120	30	60	48/24	14.318
1	1	1	100	33.3	66.6	48/24	14.318

**Power Management Modes**

PWR_DWN	CPU_STOP	PCI_STOP	CPU+	CPU-	PCICLK	PCICLK_F	Other Clocks	Oscillator	PLLs
0	X	X	Low	High	Low	Low	Low	Off	Off
1	0	0	Low	High	Low	Running	Running	Running	Running
1	0	1	Low	High	Running	Running	Running	Running	Running
1	1	0	Running	Running	Low	Running	Running	Running	Running
1	1	1	Running	Running	Running	Running	Running	Running	Running

**Notes:**

1. All control pins have internal pull-ups of 56K including: USB/IO, TEST, SPREAD, PWR\_DWN, CPU\_STOP, PCI\_STOP.
2. Part will go into test mode if three rising edges come on PCI\_STOP while XTALIN is held LOW.
3. Part will consume more shutdown current if external pull-ups are connected on latched input/outputs during power-down.
4. TCLK/4 if Select = 0; TCLK/8 if Select = 1.

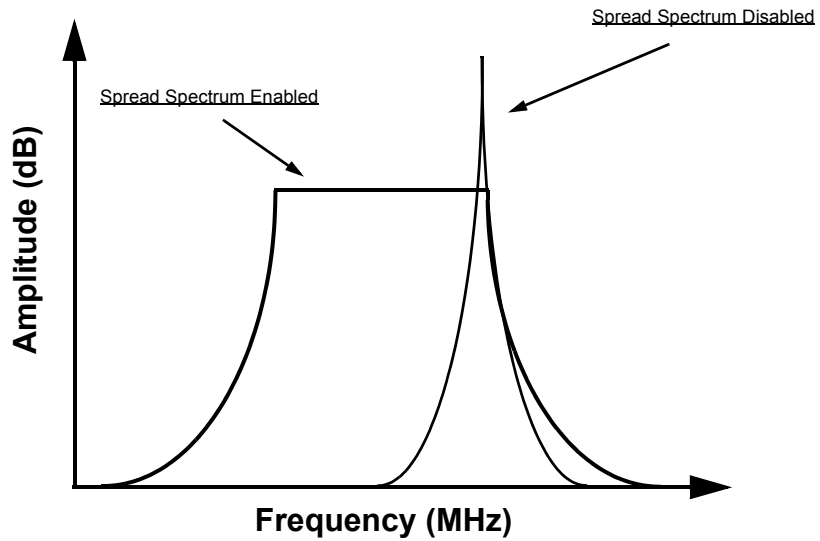
**Spread Spectrum Clocking**

Description	Output	Min	Max	Unit
Modulation Frequency	CPUCLK, PCICLK, SDRAM_OUT, AGPCLK	30.0	33.0	kHz
Downspread margin at the fundamental frequency	CPUCLK, PCICLK, SDRAM_OUT, AGPCLK	0.0	-0.6	%

**Serial Configuration Map**

- The Serial bits will be read by the clock driver in the following order:

Byte 0 - Bits 7, 6, 5, 4, 3, 2, 1, 0

Byte 1 - Bits 7, 6, 5, 4, 3, 2, 1, 0

Byte N - Bits 7, 6, 5, 4, 3, 2, 1, 0

- SPI Address for the CY22K7 is:

A6	A5	A4	A3	A2	A1	A0	R/W
1	1	0	1	0	0	1	-

Bytes 0 to 3 will be ignored.

**Byte 4: Clock Control Register (1 = Active, 0 = Inactive)**

Bit	Pin #	Default	Description
7	1	Active	REF0
6	24	Active	USB/IO
5	23	Active	USB0
4	20	Active	AGP1
3	19	Active	AGP0
2	42, 43	Active	CPUCLK2 (both of differential pair, "True" and "Complementary")
1	39, 40	Active	CPUCLK1 (both of differential pair, "True" and "Complementary")
0	36, 37	Active	CPUCLK0 (both of differential pair, "True" and "Complementary")

**Byte 5: PCI/REF Clock Control Register (1 = Active, 0 = Inactive)**

Bit	Pin #	Default	Description
7	2	Active	REF1
6	17	Active	PCICLK6
5	16	Active	PCICLK5
4	14	Active	PCICLK4
3	13	Active	PCICLK3
2	11	Active	PCICLK2
1	10	Active	PCICLK1
0	8	Active	PCICLK0

**Byte 6: SDRAM Clock & Generator Mode Control Register (1 = Active, 0 = Inactive)**

Bit	Pin #	Default	Description
7	-	Inactive	Spread Spectrum
6	-	Active	Bits[6:4] correspond to the Function Table on page 3 Bit 6 = TEST, Bit 5 = FS1, Bit 4 = FS0 example: Bits[6:4] = '111' -- 100-MHz CPUCLK and SDRAM_OUT clocks
5	-	Active	
4	-	Active	
3	-	Active	Reserved
2	-	Active	Reserved
1	-	Inactive	SPI (directs the generator to utilize either SPI feature selection if bit is enabled or pin-based feature if bit is disabled)
0	46	Active	SDRAM_OUT

**Maximum Ratings**

(Above which the useful life may be impaired. For user guidelines, not tested.)

Supply Voltage ..... – 0.5 to +4.0V  
 Input Voltage ..... – 0.5V to  $V_{DD} + 0.5$

Storage Temperature (Non-Condensing) .. – 65°C to +150°C  
 Junction Temperature ..... +150°C  
 Package Power Dissipation..... 0.7W  
 Static Discharge Voltage  
 (per MIL-STD-883, Method 3015) ..... >2000V

**CY22K7 DC Operating Conditions** Over which the DC Characteristics are Guaranteed

Parameter	Description	Min.	Max.	Unit
$V_{DD}$	3.3V Power Supply Voltages	3.135	3.465	V
$T_A$	Operating Temperature, Ambient	0	70	°C
$C_L$	Maximum Capacitive Load on SDRAM_OUT PCICLK PCICLK_F AGPCLK USB, REF		30 30 30 30 20	pF
$f_{REF}$	Reference Frequency, Oscillator Nominal Value	14.318	14.318	MHz
$t_{PU}$	Power-up time for all VDD's to reach minimum specified voltage (power ramps must be monotonic)	0.05	50	ms

**Electrical Characteristics** Over the Operating Range

Parameter	Description	Test Conditions	Min.	Max.	Unit	
$V_{IH}$	High-level Input Voltage	Except Crystal Pads. Threshold voltage for crystal pads = $V_{DD}/2$	2.0		V	
$V_{IL}$	Low-level Input Voltage	Except Crystal Pads		0.8	V	
$I_{IH}$	Input High Current	$0 \leq V_{IN} \leq V_{DD}$		10	$\mu$ A	
$I_{IL}$	Input Low Current	$0 \leq V_{IN} \leq V_{DD}$		50	$\mu$ A	
$I_{OH}$	High-level Output Current	SDRAM_OUT	$V_{OUT} = 2.0V$		-19	mA
		PCICLK	$V_{OUT} = 2.0V$		-26	
		PCICLK_F	$V_{OUT} = 2.0V$		-19	
		AGPCLK	$V_{OUT} = 2.0V$		-26	
		USB, USB/IO, REF	$V_{OUT} = 2.0V$		-22	
$I_{OL}$	Low-level Output Current	CPUCLK	$V_{OUT} = 0.3V$	16		mA
		SDRAM_OUT	$V_{OUT} = 0.8V$	12		
		PCICLK	$V_{OUT} = 0.8V$	19		
		PCICLK_F	$V_{OUT} = 0.8V$	12		
		AGPCLK	$V_{OUT} = 0.8V$	19		
		USB, USB/IO, REF	$V_{OUT} = 0.8V$	16		
$I_{OZ}$	Output Leakage Current	Three-state		10	$\mu$ A	
$I_{DD}$	3.3V Power Supply Current	$V_{DD} = 3.465V, F_{CPU} = 133$ MHz		175	mA	
$I_{DDPD}$	3.3V Shutdown Current	$V_{DD} = 3.465V$		200	$\mu$ A	
$V_{IHS}$	SMBus Input High Level		0.7		V	
$V_{ILS}$	SMBus Input Low Level			0.3	V	

**Electrical Characteristics** Over the Operating Range

Parameter	Description	Test Conditions	Min.	Max.	Unit
-----------	-------------	-----------------	------	------	------

**CY22K7 CPUCLK Driver Characteristics (Open Drain)<sup>[7]</sup>**

Parameter	Description	Conditions	Min.	Typ.	Max.	Unit
V <sub>DIF</sub>	Differential Voltage	See Note 5	0.4		V <sub>pullup</sub> (External) + 0.6	V
V <sub>X</sub>	Differential Crossover Voltage	V <sub>pullup</sub> is to 1.5V	550	750	950	mV
V <sub>X</sub>	Differential Crossover Voltage	V <sub>pullup</sub> (External) = 1.4 to 1.9V Min. = (V <sub>pullup</sub> (External)/2) – 150 mV Max. = (V <sub>pullup</sub> (External)/2) + 150 mV	550	750	1100	mV

**CY22K7 Switching Characteristics<sup>[6, 7]</sup>** Over the Operating Range @ 100 MHz

Parameter	Output	Description	Test Conditions	Min.	Typ.	Max.	Unit
t <sub>1</sub>	All	Output Duty Cycle	t <sub>1A</sub> /t <sub>1B</sub> <sup>[8]</sup>	45		55	%
t <sub>2</sub>	CPU	Rising Edge Rate	At Output of CY22K7 CPU±		1.0		V/ns
t <sub>2</sub>	CPU	Rising Edge Rate	As measured at Observation Point in Figure 1		0.4		V/ns
t <sub>2</sub>	PCI	Rise Time	Between 0.4V and 2.4V			2.0	ns
t <sub>2</sub>	SDRAM_OUT	Rise Time	Between 0.4V and 2.4V			2.0	ns
t <sub>2</sub>	AGP	Rise Time	Between 0.4V and 2.4V	0.4		2.0	ns
t <sub>2</sub>	USB, REF	Rise Time	Between 0.4V and 2.4V			4.0	ns
t <sub>3</sub>	CPU	Falling Edge Rate	At Output of CY22K7 CPU±		1.0		V/ns
t <sub>3</sub>	CPU	Falling Edge Rate	As measured at Observation Point in Figure 1		0.4		V/ns
t <sub>3</sub>	PCI	Fall Time	Between 2.4V and 0.4V			2.0	ns
t <sub>3</sub>	SDRAM_OUT	Fall Time	Between 2.4V and 0.4V			2.0	ns
t <sub>3</sub>	AGP	Fall Time	Between 2.4V and 0.4V	0.4		2.0	ns
t <sub>3</sub>	USB, REF	Fall Time	Between 2.4V and 0.4V			4.0	ns
t <sub>4</sub>	CPU, PCI	CPU-PCI Offset	Load shown in Figure 1 & Figure 2		500	700	ps
t <sub>4</sub>	CPU, SDRAM	CPU-SDRAM Skew	Load shown in Figure 1 & Figure 2		500	700	ps
t <sub>4</sub>	CPU, AGP	CPU-AGP Skew	Load shown in Figure 1 & Figure 2			1000	ps
t <sub>4</sub>	CPU, CPU	CPU-CPU Skew	Load shown in Figure 1			250	ps
t <sub>4</sub>	PCI, PCI	PCI-PCI Skew	Load shown in Figure 2			500	ps
t <sub>5</sub>	CPU	Cycle-Cycle Clock Jitter	Measured at V <sub>X</sub> , t <sub>5A</sub> -t <sub>5B</sub>			250	ps

**Notes:**

- V<sub>DIF</sub> specifies the minimum input differential voltages (V<sub>TR</sub> – V<sub>CP</sub>) required for switching, where V<sub>TR</sub> is the 'true' input level and V<sub>CP</sub> is the 'complement' input level.
- All parameters specified with loaded outputs.
- All parameters for CPU are measured at observation point shown in Figure 1 on page 10 and parameters for PCI, SDRAM & AGP are measured at observation point shown in Figure 2 on page 11 unless otherwise mentioned.
- For 133-MHz Output Duty Cycle will be guaranteed at 40% Min., 60% Max.



## Switching Waveforms

### Differential Clock Parameters

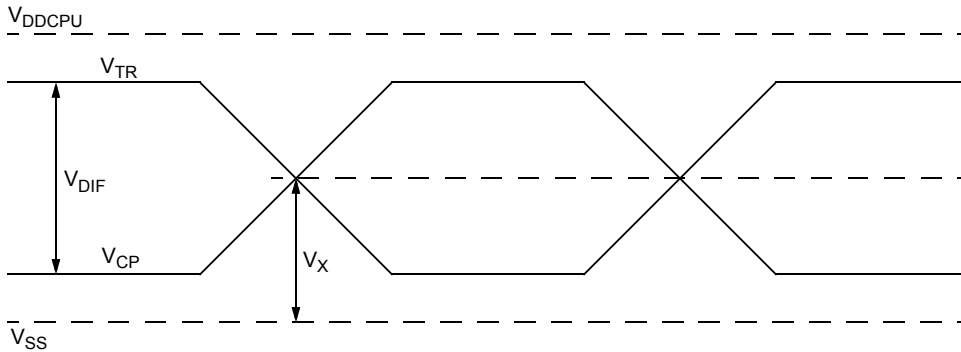

### Duty Cycle Timing

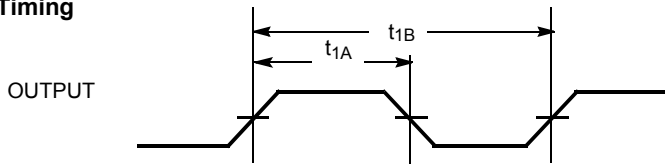

### All Outputs Rise/Fall Time

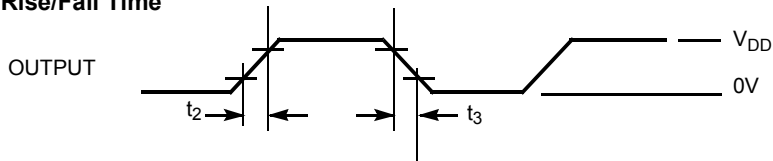

### Output\_A-Output\_B Clock Skew

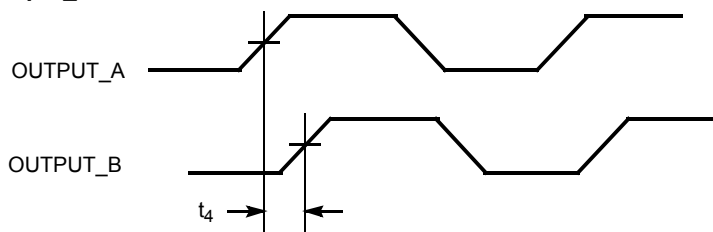

### Cycle-Cycle Clock Jitter

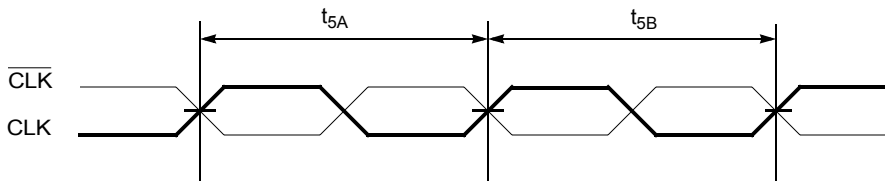

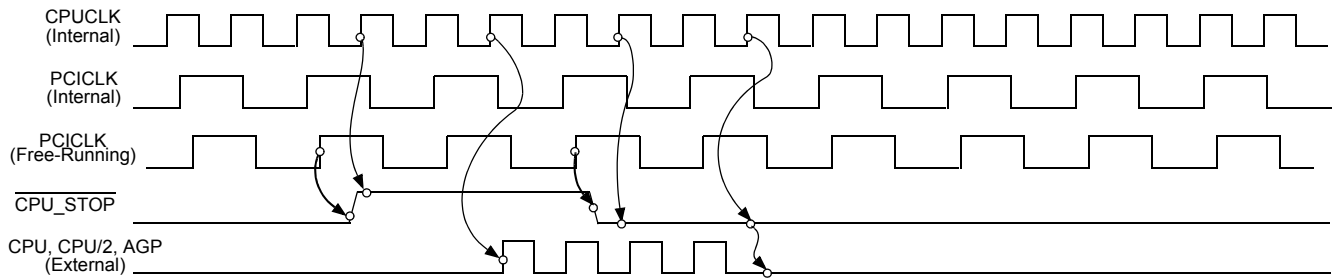
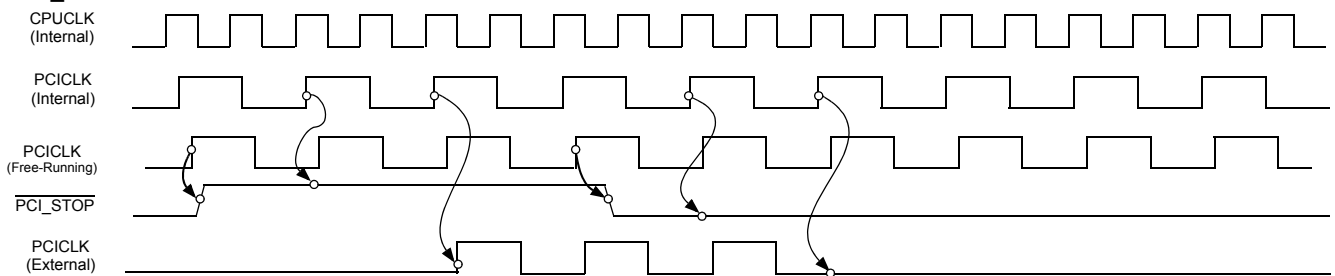
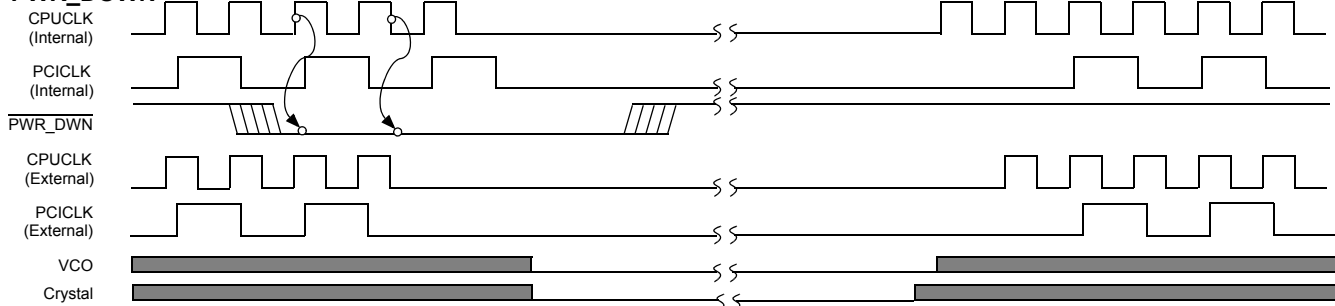
**Switching Waveforms (continued)**
**CPU\_STOP Timing<sup>[9,10]</sup>**

**PCI\_STOP**

**PWR\_DOWN<sup>[11]</sup>**

Shaded section on the VCO and Crystal waveforms indicates that the VCO and crystal oscillator are active, and there is a valid clock.

**Notes:**

9. CPUCLK on and CPUCLK off latency is 2 or 3 CPUCLK cycles.
10. CPU\_STOP may be applied asynchronously. It is synchronized internally.
11. USB, USB/IO, REF are not synchronized when entering/leaving power-down.

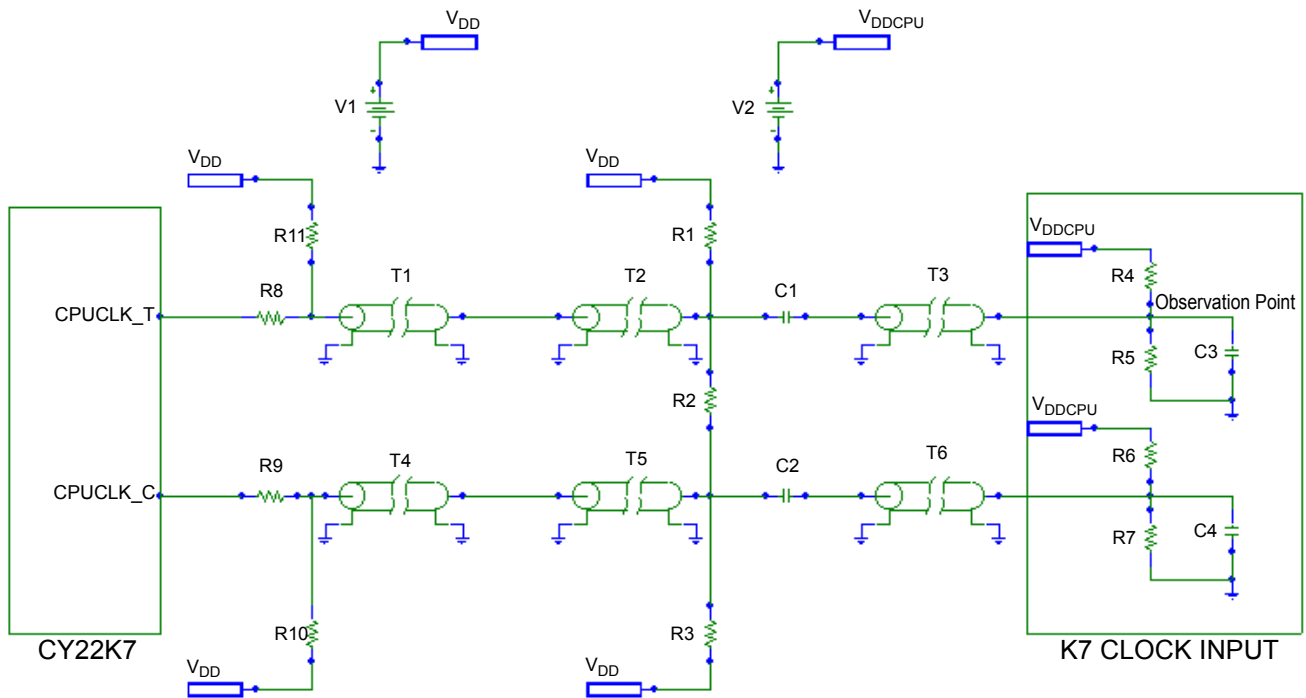
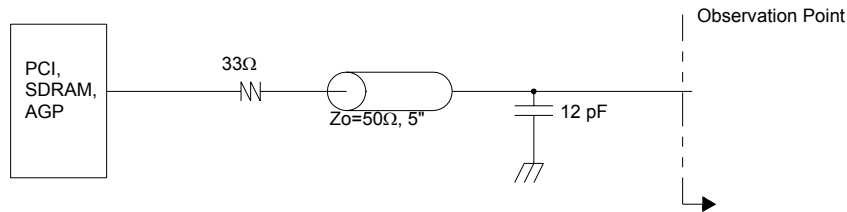

Figure 1. AMD CPU Load Circuit

### Component Values

Symbol	Value
V1	3.3V
V2	1.5V
R1,3	95Ω
R2	360Ω
R4,5,6,7	500Ω
R8,9	50Ω
R10,11	150Ω
C1,2	680 pF
C3,4	20 pF
T1,4	Z <sub>0</sub> = 50Ω
	length = 5"
T2,5	Z <sub>0</sub> = 50Ω
	length = 3"
T3,6	Z <sub>0</sub> = 50Ω
	length = 1"

**Figure 2. Test Circuit for PCI/SDRAM/AGP**
**Ordering Information**

Ordering Code	Package Name	Package Type	Operating Range
CY22K7PVC-1	O48	48-pin SSOP	Commercial

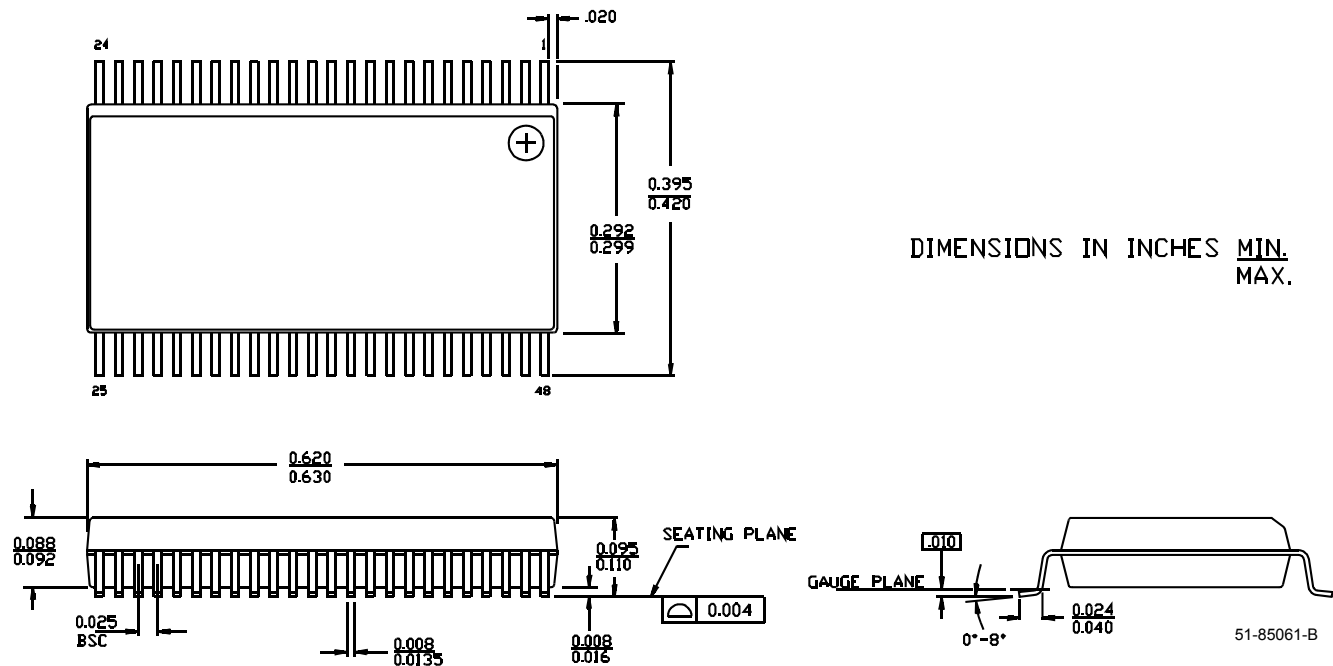
**Package Diagram**
**48-Lead Shrunken Small Outline Package O48**

AMD-K7 is a registered trademark of Advanced Micro Devices.

**Revision History**

**Document Title: CY22K7 133-MHz Spread Spectrum Clock Generator For Use With the AMD-K7® Processor and AMD-750 Chipset**  
**Document Number: 38-07333**

<b>REV.</b>	<b>ECN NO.</b>	<b>Issue Date</b>	<b>Orig. of Change</b>	<b>Description of Change</b>
**	111732	12/16/01	DSG	Change from Spec number: 38-00745 to 38-07333
*A	121856	12/14/02	RBI	Power up requirements added to Operating Conditions Information
OBS	294235	See ECN	RGL	To Obsolete the DS