

***Buck Chopper
Trench + Field Stop IGBT
Power Module***

**$V_{CES} = 1700V$
 $I_C = 200A @ T_c = 80^\circ C$**

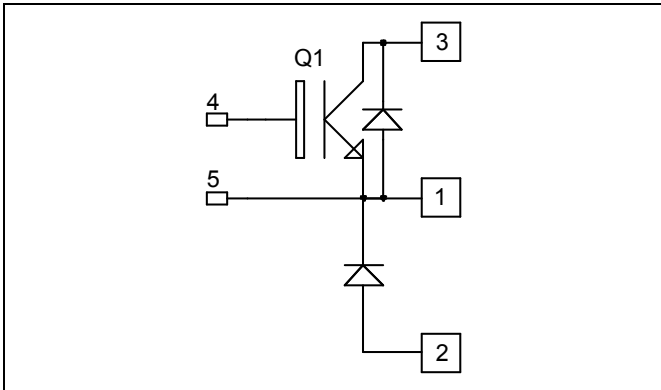

Application

- AC and DC motor control
- Switched Mode Power Supplies

Features

- Trench + Field Stop IGBT Technology
 - Low voltage drop
 - Low tail current
 - Switching frequency up to 20 kHz
 - Soft recovery parallel diodes
 - Low diode VF
 - Low leakage current
 - RBSOA and SCSOA rated
- Kelvin emitter for easy drive
- High level of integration
- M6 power connectors

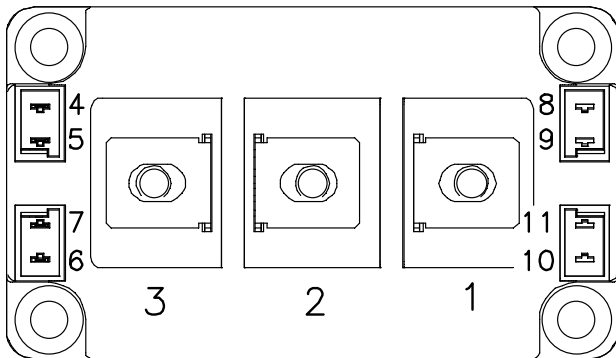

Benefits

- Stable temperature behavior
- Very rugged
- Direct mounting to heatsink (isolated package)
- Low junction to case thermal resistance
- Easy paralleling due to positive T_C of V_{CEsat}
- RoHS Compliant

Absolute maximum ratings

Symbol	Parameter	Max ratings	Unit
V_{CES}	Collector - Emitter Breakdown Voltage	1700	V
I_C	Continuous Collector Current	$T_C = 25^\circ C$	310
		$T_C = 80^\circ C$	200
I_{CM}	Pulsed Collector Current	$T_C = 25^\circ C$	400
V_{GE}	Gate - Emitter Voltage	± 20	V
P_D	Maximum Power Dissipation	$T_C = 25^\circ C$	1250
RBSOA	Reverse Bias Safe Operating Area	$T_j = 125^\circ C$	400A@1650V

CAUTION: These Devices are sensitive to Electrostatic Discharge. Proper Handling Procedures Should Be Followed. See application note APT0502 on www.microsemi.com

All ratings @ $T_j = 25^\circ\text{C}$ unless otherwise specified

Electrical Characteristics

Symbol	Characteristic	Test Conditions	Min	Typ	Max	Unit
I_{CES}	Zero Gate Voltage Collector Current	$V_{GE} = 0\text{V}, V_{CE} = 1700\text{V}$			3	mA
$V_{CE(on)}$	Collector Emitter on Voltage	$V_{GE} = 15\text{V}$ $I_C = 200\text{A}$	$T_j = 25^\circ\text{C}$	2.0	2.5	V
			$T_j = 125^\circ\text{C}$	2.4		
$V_{GE(th)}$	Gate Threshold Voltage	$V_{GE} = V_{CE}, I_C = 8\text{mA}$	5.2	5.8	6.4	V
I_{GES}	Gate – Emitter Leakage Current	$V_{GE} = 20\text{V}, V_{CE} = 0\text{V}$			400	nA

Dynamic Characteristics

Symbol	Characteristic	Test Conditions	Min	Typ	Max	Unit
C_{ies}	Input Capacitance	$V_{GE} = 0\text{V}, V_{CE} = 25\text{V}$		18		nF
C_{res}	Reverse Transfer Capacitance	$f = 1\text{MHz}$		0.6		
Q_G	Gate charge	$V_{GE} = \pm 15\text{V}, I_C = 200\text{A}$ $V_{CE} = 900\text{V}$		2.3		μC
$T_{d(on)}$	Turn-on Delay Time	Inductive Switching (25°C) $V_{GE} = \pm 15\text{V}$ $V_{Bus} = 900\text{V}$ $I_C = 200\text{A}$ $R_G = 6.8\Omega$		280		ns
T_r	Rise Time			80		
$T_{d(off)}$	Turn-off Delay Time			850		
T_f	Fall Time			120		
$T_{d(on)}$	Turn-on Delay Time	Inductive Switching (125°C) $V_{GE} = \pm 15\text{V}$ $V_{Bus} = 900\text{V}$ $I_C = 200\text{A}$ $R_G = 6.8\Omega$		300		ns
T_r	Rise Time			100		
$T_{d(off)}$	Turn-off Delay Time			1000		
T_f	Fall Time			200		
E_{on}	Turn On Energy	$V_{GE} = \pm 15\text{V}$ $V_{Bus} = 900\text{V}$	$T_j = 25^\circ\text{C}$	58		mJ
			$T_j = 125^\circ\text{C}$	78		
E_{off}	Turn Off Energy	$I_C = 200\text{A}$ $R_G = 6.8\Omega$	$T_j = 25^\circ\text{C}$	43		mJ
			$T_j = 125^\circ\text{C}$	63		
I_{sc}	Short Circuit data	$V_{GE} \leq 15\text{V}; V_{Bus} = 1000\text{V}$ $t_p \leq 10\mu\text{s}; T_j = 125^\circ\text{C}$		800		A

Reverse diode ratings and characteristics

Symbol	Characteristic	Test Conditions	Min	Typ	Max	Unit
V_{RRM}	Maximum Peak Repetitive Reverse Voltage		1700			V
I_{RRM}	Maximum Reverse Leakage Current	$V_R = 1700\text{V}$	$T_j = 25^\circ\text{C}$		750	μA
			$T_j = 125^\circ\text{C}$		1000	
I_F	DC Forward Current		$T_c = 80^\circ\text{C}$	200		A
V_F	Diode Forward Voltage	$I_F = 200\text{A}$	$T_j = 25^\circ\text{C}$	1.8	2.2	V
			$T_j = 125^\circ\text{C}$	1.9		
t_{rr}	Reverse Recovery Time	$I_F = 200\text{A}$ $V_R = 900\text{V}$ $di/dt = 3200\text{A}/\mu\text{s}$	$T_j = 25^\circ\text{C}$	385		ns
			$T_j = 125^\circ\text{C}$	490		
Q_{rr}	Reverse Recovery Charge		$T_j = 25^\circ\text{C}$	56		μC
			$T_j = 125^\circ\text{C}$	92		
E_{rr}	Reverse Recovery Energy		$T_j = 25^\circ\text{C}$	24		mJ
			$T_j = 125^\circ\text{C}$	48		

Thermal and package characteristics

Symbol	Characteristic	Min	Typ	Max	Unit	
R _{thJC}	Junction to Case Thermal Resistance	IGBT		0.10	°C/W	
		Diode		0.16		
V _{ISOL}	RMS Isolation Voltage, any terminal to case t=1 min, I _{isol} <1mA, 50/60Hz	3500			V	
T _J	Operating junction temperature range	-40		150	°C	
T _{STG}	Storage Temperature Range	-40		125		
T _C	Operating Case Temperature	-40		125		
Torque	Mounting torque	For terminals	M6	3	5	N.m
		To Heatsink	M6	3	5	
Wt	Package Weight			350	g	

D3 Package outline (dimensions in mm)

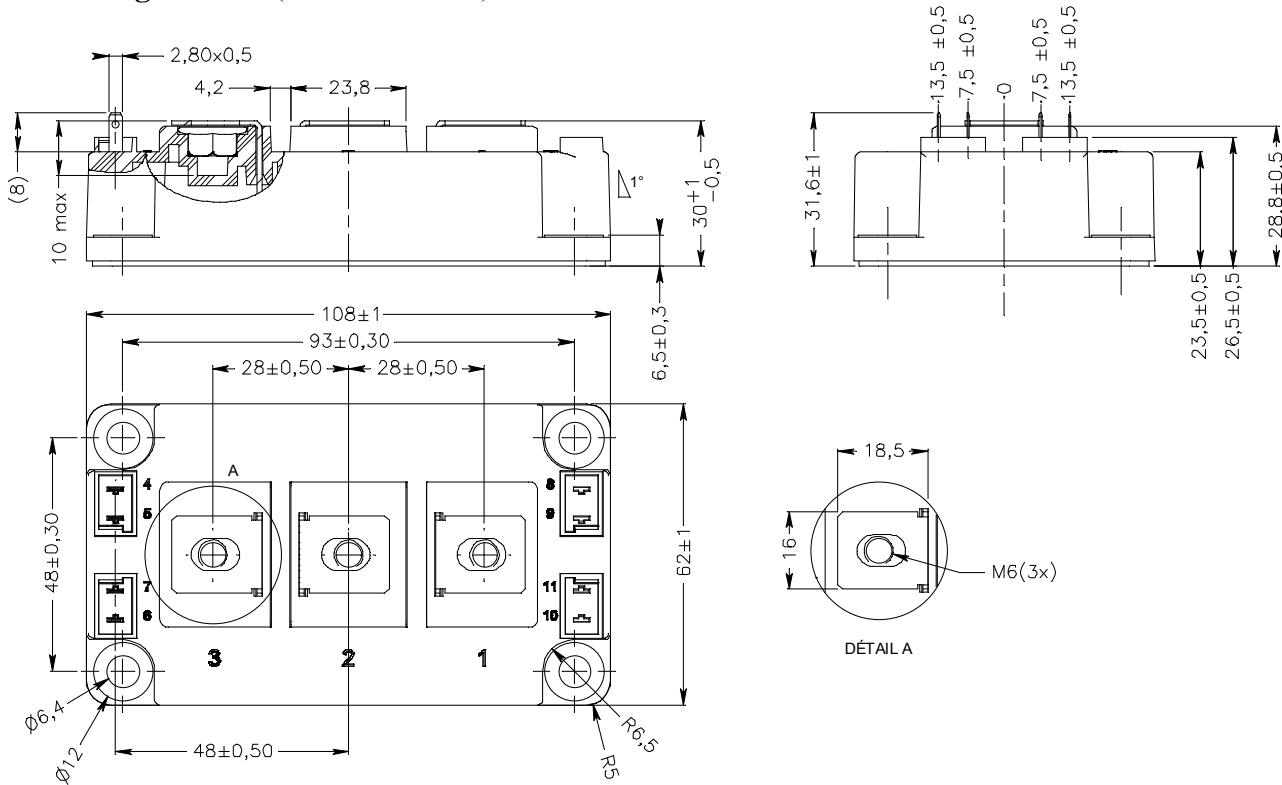

Typical Performance Curve

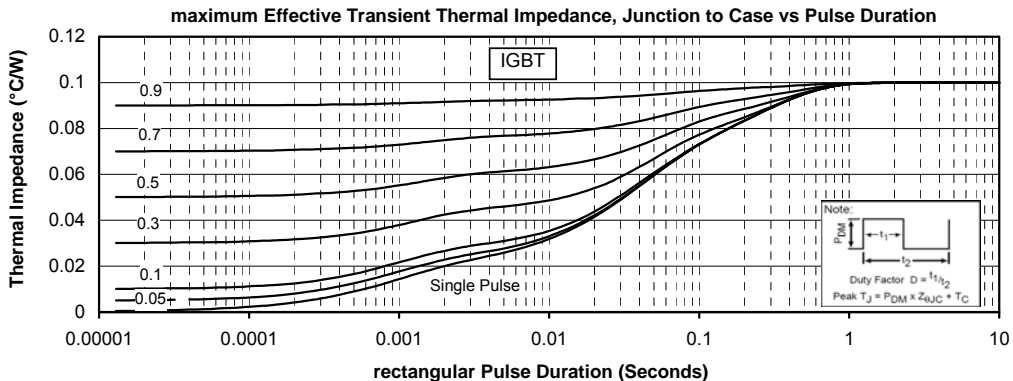
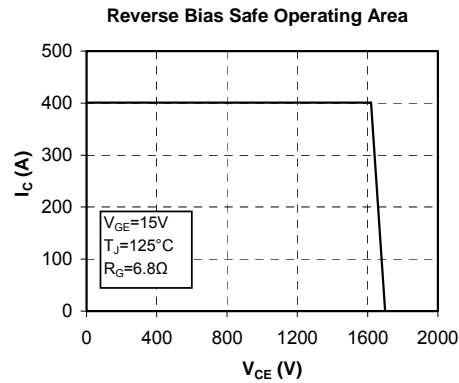
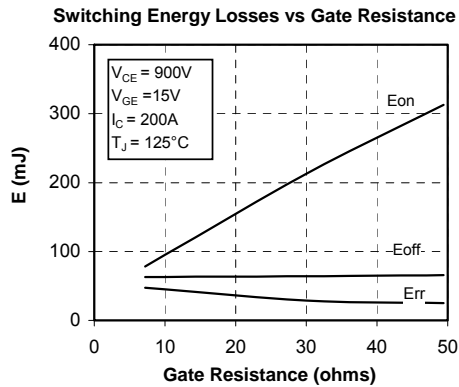
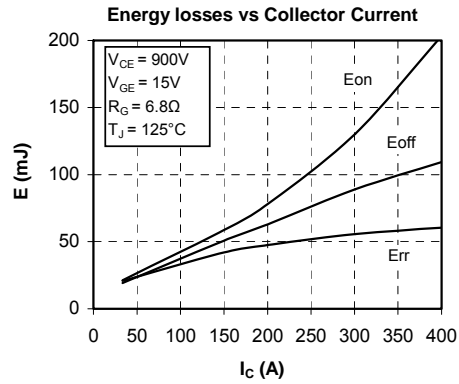
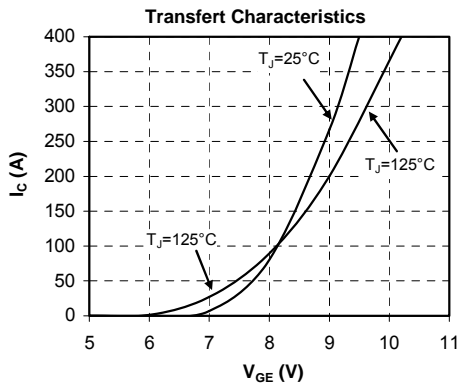
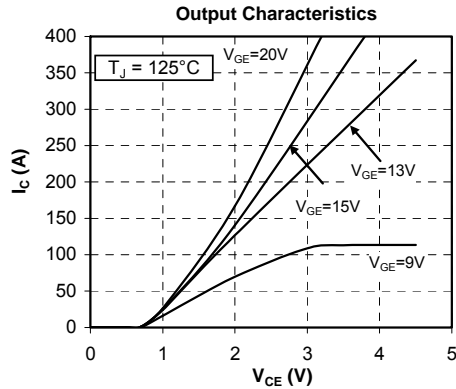
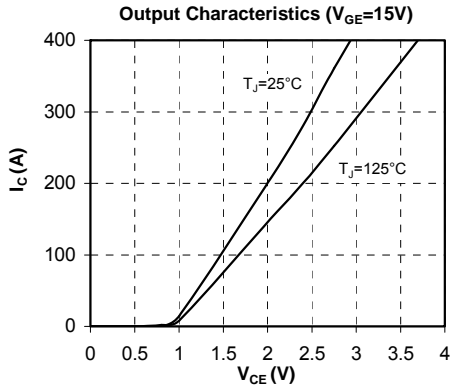

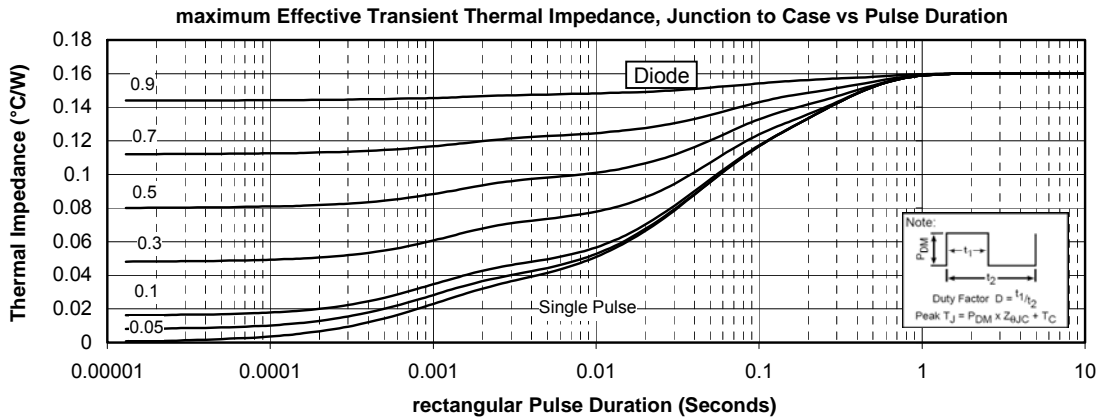
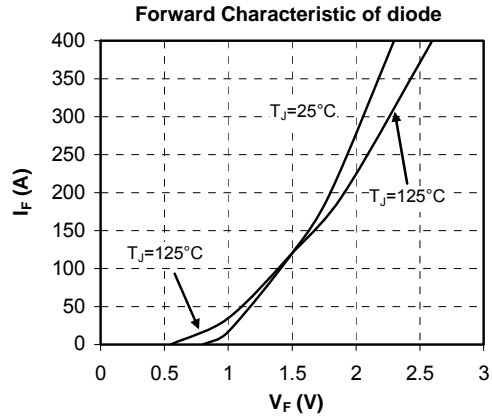
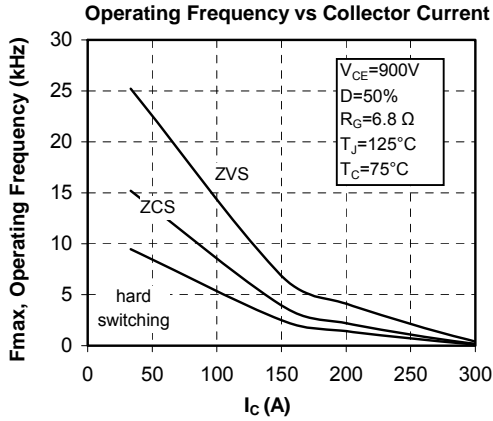

Microsemi reserves the right to change, without notice, the specifications and information contained herein

Microsemi's products are covered by one or more of U.S. patents 4,895,810 5,045,903 5,089,434 5,182,234 5,019,522 5,262,336 6,503,786 5,256,583 4,748,103 5,283,202 5,231,474 5,434,095 5,528,058 6,939,743 7,352,045 5,283,201 5,801,417 5,648,283 7,196,634 6,664,594 7,157,886 6,939,743 7,342,262 and foreign patents. U.S. and Foreign patents pending. All Rights Reserved.