

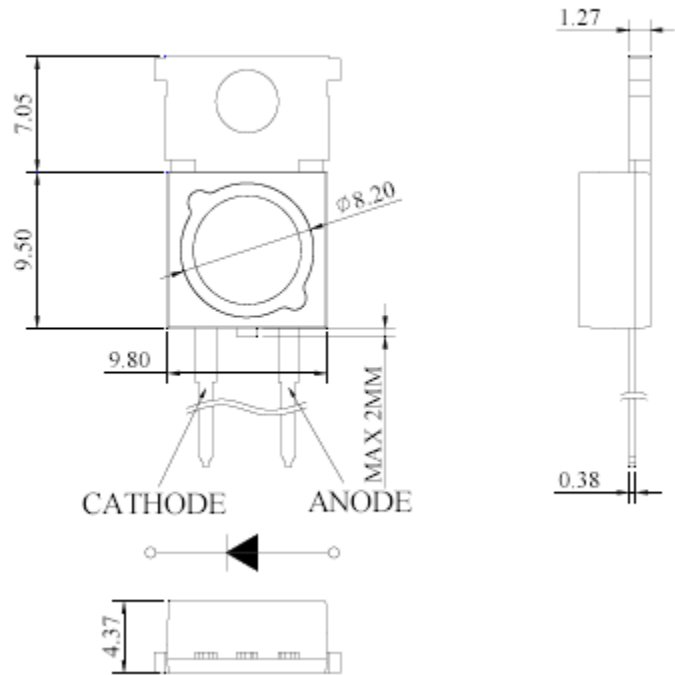

### Non Lens(120°) Dip Package Outlines



#### SELECTOR GUIDE

Part Number	Dice	Lens Color / Type	Pack Size	View Angle 2θ 1/2
MTHF1000-WN	White	No Lens	1-Watt	120 °

#### ELECTRICAL / OPTICAL CHARACTERISTICS AT T<sub>A</sub>=25°C

Parameter	Symbol	Device	Min.	Typ.	Max.	Units	Test Conditions
Forward Voltage	V <sub>F</sub>	White	-	3.475	4.25	V	350mA
Reverse Current	I <sub>R</sub>	White	-	-	50	μA	5V
Luminous Intensity	I <sub>V</sub>	White	23.5	37.55	-	lm	350mA
Correlated Color Temperature		White	-	6500	-	°K	350mA

#### ABSOLUTE MAXIMUM RATINGS AT T<sub>A</sub>=25°C

Parameter	Rating	Units
Forward Current ( I <sub>F</sub> )	350	mA
Power Dissipation ( P <sub>D</sub> )	-	mW
Reverse Voltage ( V <sub>R</sub> )	5	V
Operating Temperature ( T <sub>OPR</sub> )	-40 ~ +75	°C
Storage Temperature ( T <sub>STG</sub> )	-40 ~ +105	°C
Lead Solder Temperature ( T <sub>SOL</sub> )	260 @ for 10 sec. max	

1. All Dimensions Are In Millimeters (inches).
2. Tolerance Is +0.25(0.01") Unless Otherwise Noted.
3. Specifications Are Subject To Change Without Notice.

Typical Radiation Pattern for Non Lens(201/2 : 120±10°)

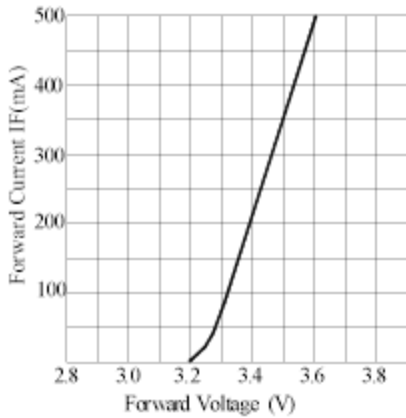
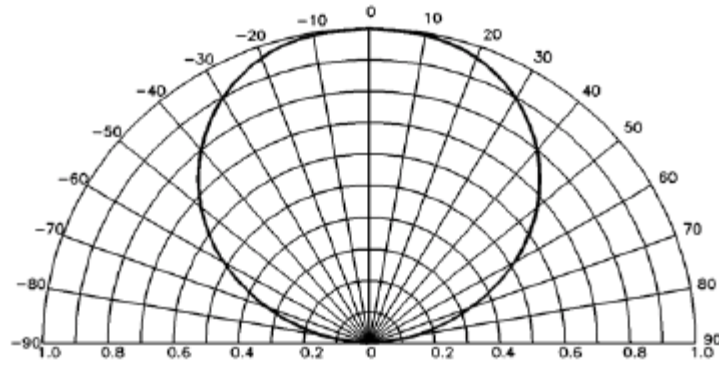

Forward Current VS. Applied Voltage

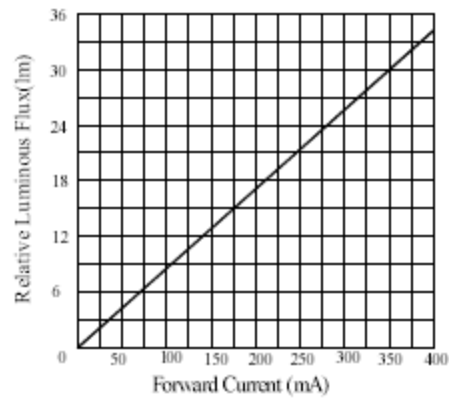

Forward Current VS. Luminous Intensity

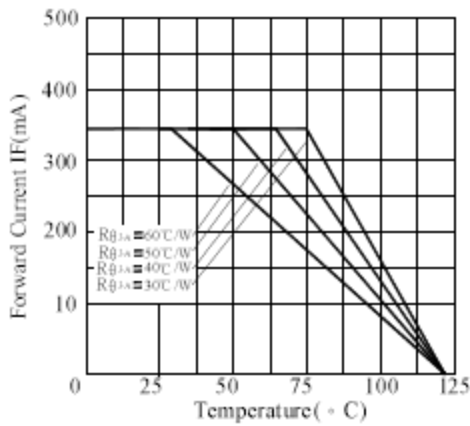

Ambient Temperature VS. Forward Current

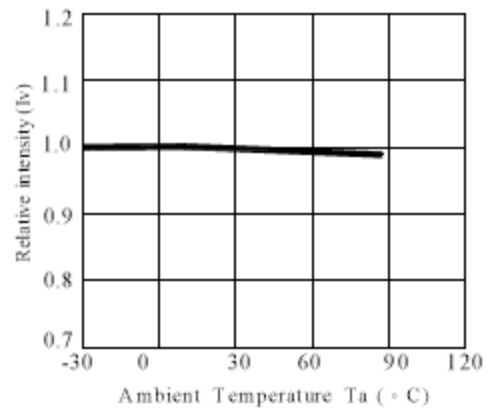

Relative intensity VS. Ambient Temperature

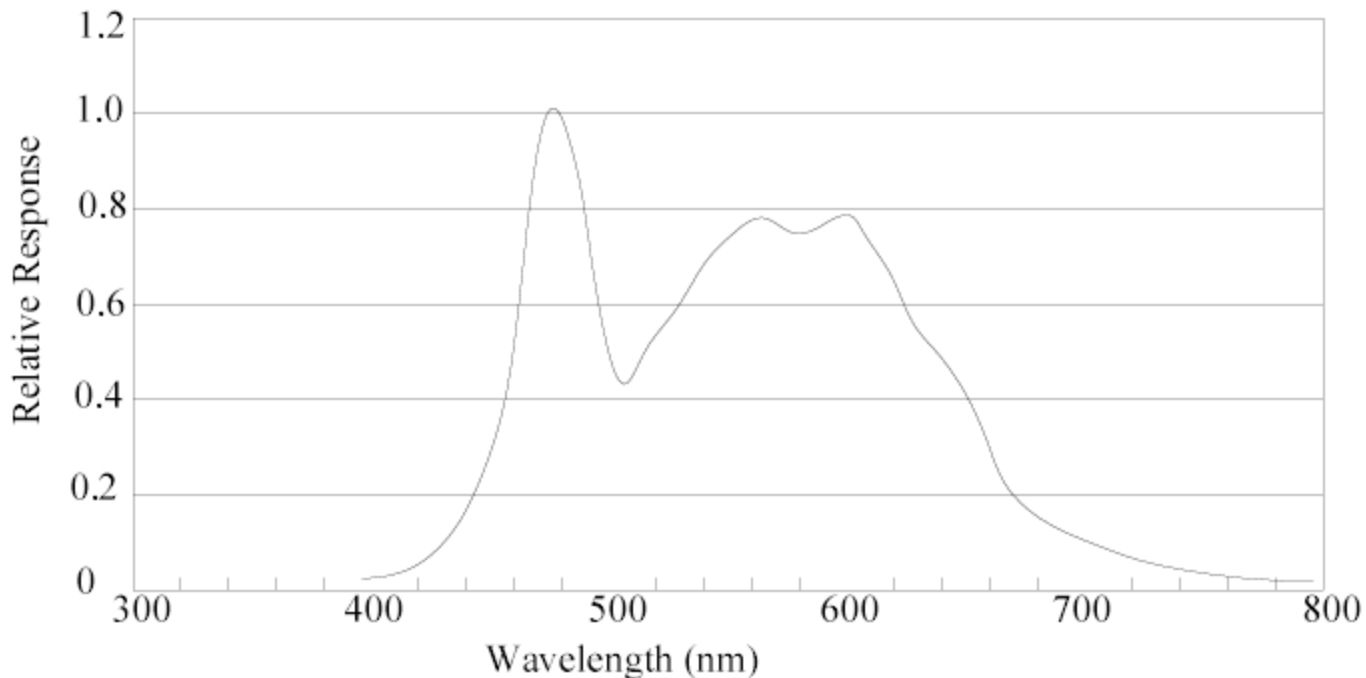

Fig.1 WHITE LED Spectrum VS. WAVELENGTH