

**PLEASE CHECK WWW.MOLEX.COM FOR LATEST PART INFORMATION**

**Part Number:** [0674911130](#)  
**Status:** **Active**  
**Overview:** Serial ATA Products  
**Description:** 1.27mm (.050") Pitch Serial ATA High Speed Header, High Temperature Thermoplastic, Through Hole, Vertical, 7 Circuits, Gold (Au) Flash Plating, with 2.05mm (.081") PC Tail Length, for 1.60mm (.093") PCB, Lead-free

**Documents:**

[3D Model](#) [Product Specification PS-67491-001 \(PDF\)](#)  
[Drawing \(PDF\)](#) [RoHS Certificate of Compliance \(PDF\)](#)

**General**

Product Family	PCB Headers
Series	<a href="#">67491</a>
Application	Board-to-Board, Wire-to-Board
Overview	<a href="#">Serial ATA Products</a>
Product Name	Serial ATA

**Physical**

Breakaway	No
Circuits (Loaded)	7
Color - Resin	Black
Durability (mating cycles max)	50
First Mate / Last Break	Yes
Glow-Wire Compliant	No
Guide to Mating Part	No
Keying to Mating Part	Yes
Lock to Mating Part	Yes
Material - Plating Mating	Gold
Material - Plating Termination	Tin
Material - Resin	High Temperature Thermoplastic
Number of Rows	1
Orientation	Vertical
PC Tail Length (in)	0.081 In
PC Tail Length (mm)	2.05 mm
PCB Locator	Yes
PCB Retention	Yes
PCB Thickness Recommended (in)	0.063 In
PCB Thickness Recommended (mm)	1.60 mm
Packaging Type	Tray
Pitch - Mating Interface (in)	0.050 In
Pitch - Mating Interface (mm)	1.27 mm
Pitch - Term. Interface (in)	0.050 In
Pitch - Term. Interface (mm)	1.27 mm
Plating min: Mating (µin)	2
Plating min: Mating (µm)	0.05
Plating min: Termination (µin)	50.8
Plating min: Termination (µm)	1.27
Polarized to Mating Part	Yes
Polarized to PCB	Yes
Shrouded	No
Stackable	No
Surface Mount Compatible (SMC)	Yes
Temperature Range - Operating	-35°C to +85°C
Termination Interface: Style	Through Hole

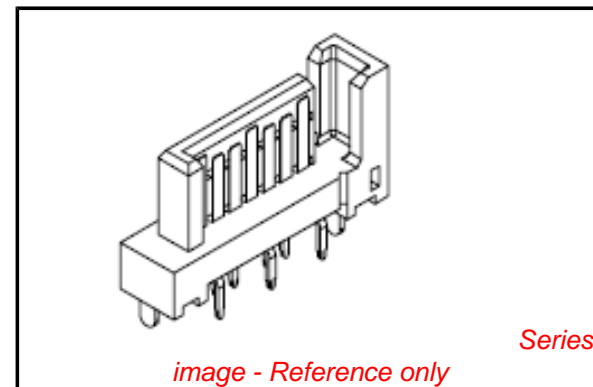

**EU RoHS**

**ELV and RoHS  
Compliant**  
**REACH SVHC  
Not Reviewed**  
**Halogen-Free  
Status**

**China RoHS**



**Need more information on product  
environmental compliance?**

Email [productcompliance@molex.com](mailto:productcompliance@molex.com)  
 For a multiple part number RoHS Certificate of Compliance, [click here](#)

Please visit the [Contact Us](#) section for any non-product compliance questions.

**Search Parts in this Series**

[67491Series](#)

**Mates With**

Serial ATA Signal Connector [67489](#) , [88755](#)

**Electrical**

Current - Maximum per Contact

1.5A

Voltage - Maximum

15V DC

**Material Info****Reference - Drawing Numbers**

Product Specification

PS-67491-001

Sales Drawing

SD-67491-002

This document was generated on 04/21/2010

**PLEASE CHECK [WWW.MOLEX.COM](http://WWW.MOLEX.COM) FOR LATEST PART INFORMATION**

	10	9	8	7	6	
	P/N	CONTACT PLATING TYPE	"A"	"B"	PCB THICKNESS	SOLDERING PLATE
F	67491-0030	GOLD FLASH	2.05	2.40	1.60	TIN-LEAD
	67491-0031	0.76 MICRON GOLD PLATED				
	67491-0032	0.38 MICRON GOLD PLATED				
E	67491-0035	GOLD FLASH	2.35	2.40	2.00	
	67491-0036	0.76 MICRON GOLD PLATED				
	67491-0037	0.38 MICRON GOLD PLATED				
D	67491-0038	GOLD FLASH	3.00	3.20	2.40	
	67491-0039	0.76 MICRON GOLD PLATED				
	67491-0040	0.38 MICRON GOLD PLATED				
C	67491-1030	GOLD FLASH	2.05	2.40	1.60	PURE TIN
	67491-1031	0.76 MICRON GOLD PLATED				
	67491-1032	0.38 MICRON GOLD PLATED				
B	67491-1035	GOLD FLASH	2.35	2.40	2.00	
	67491-1036	0.76 MICRON GOLD PLATED				
	67491-1037	0.38 MICRON GOLD PLATED				
A	67491-1038	GOLD FLASH	3.00	3.20	2.40	
	67491-1039	0.76 MICRON GOLD PLATED				
	67491-1040	0.38 MICRON GOLD PLATED				

- NOTES:
- MATERIAL :  
HOUSING: THERMAL PLASTIC, UL94V-0, COLOR: BLACK  
TERMINAL/PEG: COPPER ALLOY
  - TERMINAL PLATING :  
CONTACT AREA:  
GOLD PLATED  
SOLDER TAIL:  
1.27 MOICRON MIN. TIN-LEAD OR TIN PLATED  
UNDER PLATE:  
1.27 MOICRON MIN. NICKEL PLATED
  - PEG PLATING:  
1.27 MOICRON MIN. TIN-LEAD OR TIN PLATED  
OVERALL 1.27 MOICRON MIN. TNICKEL UNDER PLATED
  - PACKAGING SPECIFICATION REFER TO PK-67491-001
  - PRODUCT SPECIFICATION REFER TO PS-67491-001
  - MATING PART: 67489
  - RECOMMENDED PROCESS: WAVE SOLDERING

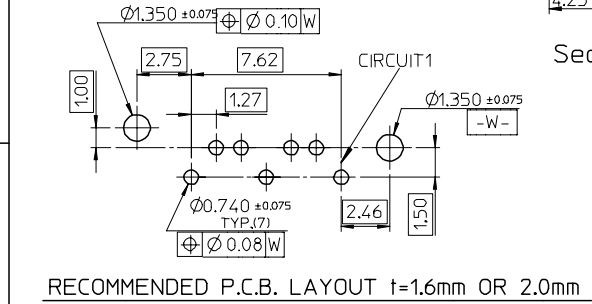
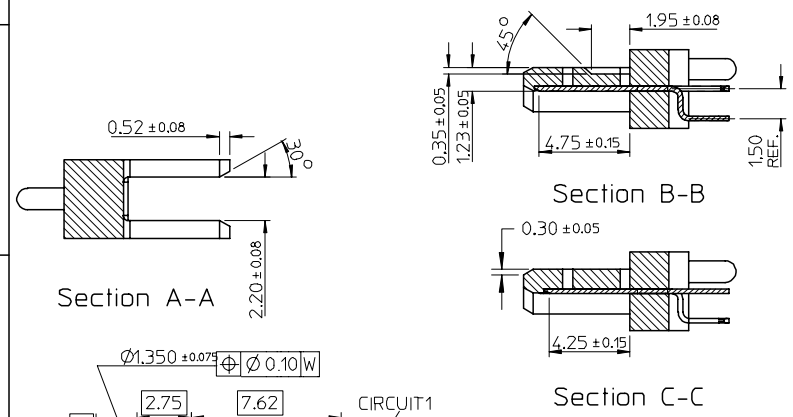
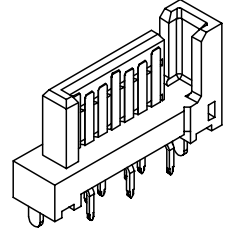
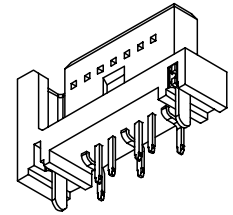
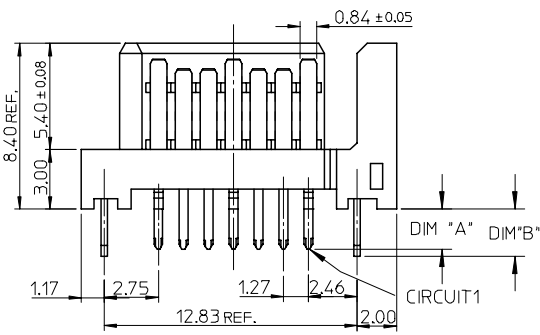
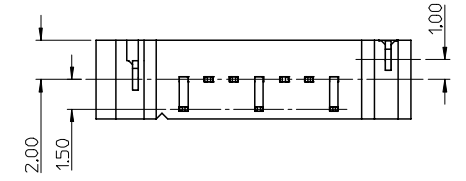
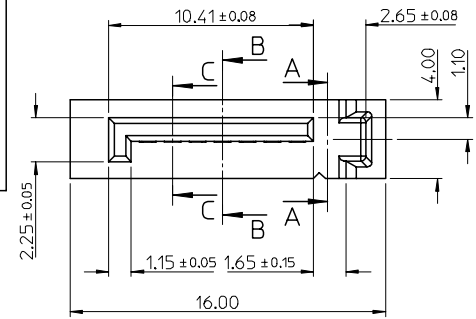
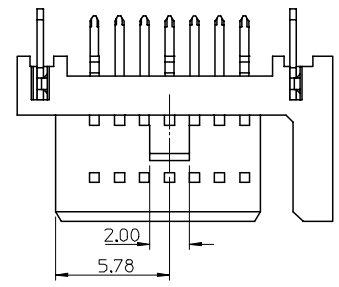

EC NO: SH2005-0049 DRWN:GRMA 2004/09/03 CHKD:GRATE M&004/09/07 APPR: YTYAP 2004/09/10	QUALITY SYMBOLS ▽ - 0 ▽ - 0	GENERAL TOLERANCES (UNLESS SPECIFIED)	SCALE 4:1	DESIGN UNITS METRIC	THIRD ANGLE PROJECTION	REVISE ON CAD ONLY																
		<table border="1"> <thead> <tr> <th></th> <th>mm</th> <th>INCH</th> </tr> </thead> <tbody> <tr> <td>4 PLACES</td> <td>± ---</td> <td>± ---</td> </tr> <tr> <td>3 PLACES</td> <td>± ---</td> <td>± ---</td> </tr> <tr> <td>2 PLACES</td> <td>± 0.15</td> <td>± ---</td> </tr> <tr> <td>1 PLACE</td> <td>± 0.25</td> <td>± ---</td> </tr> <tr> <td colspan="3">ANGULAR ± 3°</td> </tr> </tbody> </table>		mm	INCH	4 PLACES	± ---	± ---	3 PLACES	± ---	± ---	2 PLACES	± 0.15	± ---	1 PLACE	± 0.25	± ---	ANGULAR ± 3°			DIMENSION STYLE MM ONLY	TITLE
	mm	INCH																				
4 PLACES	± ---	± ---																				
3 PLACES	± ---	± ---																				
2 PLACES	± 0.15	± ---																				
1 PLACE	± 0.25	± ---																				
ANGULAR ± 3°																						
C	DESCRIPTION	DRAFT WHERE APPLICABLE	DRAWN BY RICHARD	DATE '01/06/21	MOLEX INCORPORATED																	
		MUST REMAIN WITHIN DIMENSIONS	CHECKED BY VINCENT	DATE '01/06/21	MATERIAL NO. SEE TABLE	DOCUMENT NO. SD-67491-002	SHEET NO. 1 OF 1															
		APPROVED BY ERIC		DATE '01/06/21	THIS DRAWING CONTAINS INFORMATION THAT IS PROPRIETARY TO MOLEX INCORPORATED AND SHOULD NOT BE USED WITHOUT WRITTEN PERMISSION																	

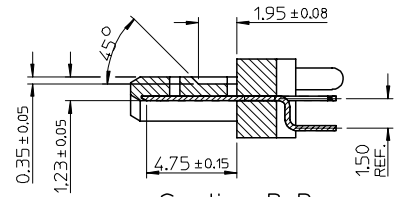

Section B-B

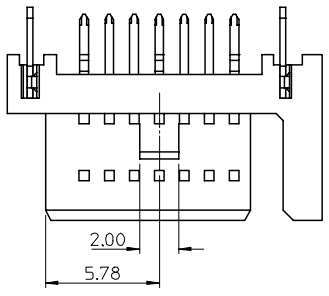

- NOTES:
- MATERIAL:
    - HOUSING: SEE TABLE, UL94V-0, COLOR: BLACK OR BULE (SEE P/N TABLE)
    - TERMINAL/PEG: COPPER ALLOY
  - TERMINAL PLATING :
    - CONTACT AREA: GOLD PLATED
    - SOLDER TAIL: 1.27 MICRON MIN. TIN PLATED
    - UNDER PLATE: 1.27 MICRON MIN. NICKEL PLATED
  - PEG PLATING:
    - 1.27 MICRON MIN. TIN PLATED
    - OVERALL 1.27 MICRON MIN. NICKEL UNDER PLATED
  - PACKAGING SPECIFICATION REFER TO PK-67491-001
  - PRODUCT SPECIFICATION REFER TO PS-67491-001
  - MATING PART: 67489
  - RECOMMENDED PROCESS: WAVE SOLDERING
  - PRODUCT COMPLIANT TO RoHS DIRECTIVE 2002/95/EC AND ELV DIRECTIVE 2000/53/EC"

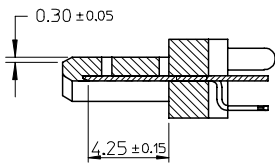

Section C-C

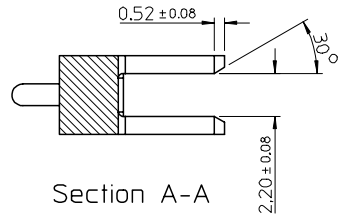
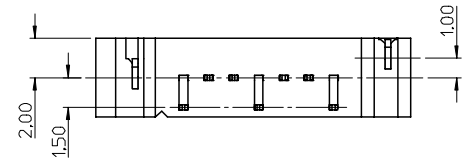
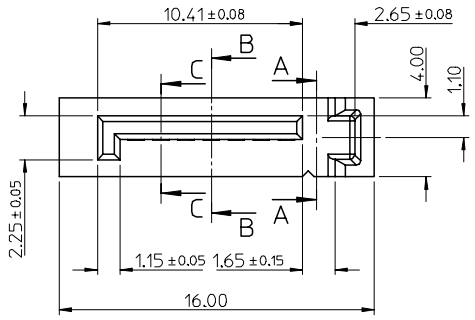



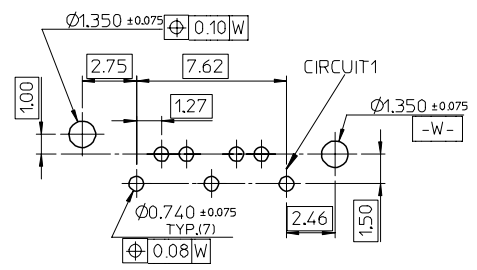
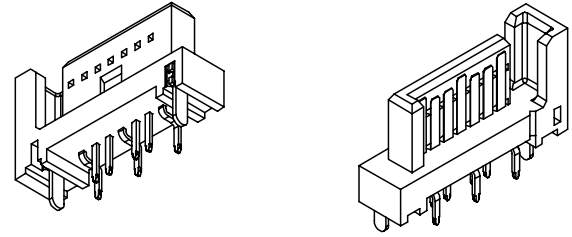
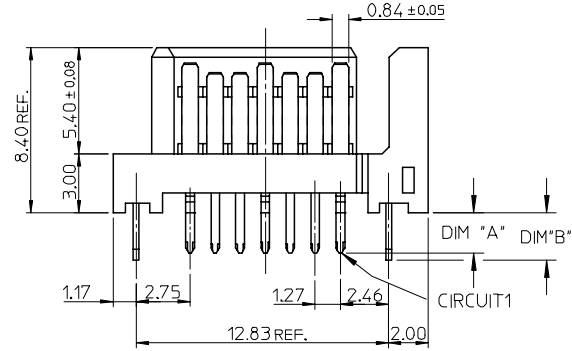

Section A-A



RECOMMENDED P.C.B. LAYOUT t=1.6mm OR 2.0mm

ADD PART NUMBER EC NO: SH2007-0134 DRWN: BCHENZ6 CHKD: JTIAN APPR: JNCHEN	QUALITY SYMBOLS ▽=0 ▽=0	GENERAL TOLERANCES (UNLESS SPECIFIED)		DIMENSION STYLE MM ONLY		SCALE 4:1	DESIGN UNITS METRIC	THIRD ANGLE PROJECTION	
				DRAWN BY DATE		TITLE			
				CHECKED BY DATE		1.27MM HIGH SPEED SERIAL PLUG VERTICAL TYPE			
				APPROVED BY DATE		MOLEX INCORPORATED			
		ANGULAR ± 3°		MATERIAL NO.		DOCUMENT NO.		SHEET NO.	
		DRAFT WHERE APPLICABLE MUST REMAIN WITHIN DIMENSIONS		SEE SHEET 2		SD-67491-002		1 OF 2	
		THIS DRAWING CONTAINS INFORMATION THAT IS PROPRIETARY TO MOLEX INCORPORATED AND SHOULD NOT BE USED WITHOUT WRITTEN PERMISSION							

	10	9	8	7	6	5	4	3	2	1			
	P/N	CONTACT PLATING TYPE	"A"	"B"	PCB THICKNESS	SOLDERING PLATE	COLOR	PLASTIC TYPE					
F	67491-1030	GOLD FLASH	2.05	2.40	1.60	PURE TIN	BLACK		<div style="text-align: center;">  </div>				
	67491-1031	0.76 MICRON GOLD PLATED											
	67491-1032	0.38 MICRON GOLD PLATED											
67491-1035	GOLD FLASH												
67491-1036	0.76 MICRON GOLD PLATED												
67491-1037	0.38 MICRON GOLD PLATED												
E	67491-1038	GOLD FLASH	3.00	3.20	2.40		PURE TIN	BLACK			THERMAL PLASTIC	<div style="text-align: center;">  </div>	
	67491-1039	0.76 MICRON GOLD PLATED											
	67491-1040	0.38 MICRON GOLD PLATED											
67491-2030	GOLD FLASH												
67491-2031	0.76 MICRON GOLD PLATED												
67491-2032	0.38 MICRON GOLD PLATED												
D	67491-2035	GOLD FLASH	2.35	2.40	2.00	PURE TIN	BLUE PENTONE NO.293C ΔE<3	THERMAL PLASTIC	<div style="text-align: center;">  </div>				
	67491-2036	0.76 MICRON GOLD PLATED											
	67491-2037	0.38 MICRON GOLD PLATED											
67491-2038	GOLD FLASH												
67491-2039	0.76 MICRON GOLD PLATED												
67491-2040	0.38 MICRON GOLD PLATED												
C	67491-1130	GOLD FLASH	2.05	2.40	1.60	PURE TIN	BLACK	HIGH TEMPERATURE THERMAL PLASTIC			<div style="text-align: center;">  </div>		
	67491-1131	0.76 MICRON GOLD PLATED											
	67491-1132	0.38 MICRON GOLD PLATED											
	67491-1135	GOLD FLASH											
	67491-1136	0.76 MICRON GOLD PLATED											
	67491-1137	0.38 MICRON GOLD PLATED											
	67491-1138	GOLD FLASH	3.00	3.20	2.40	PURE TIN	BLACK	HIGH TEMPERATURE THERMAL PLASTIC	<div style="text-align: center;">  </div>				
	67491-1139	0.76 MICRON GOLD PLATED											
	67491-1140	0.38 MICRON GOLD PLATED											

B

<b>ADD PART NUMBER</b> EC NO: SH2007-0134 DRWN: B. CHENZ CHKD: J. TIAN APPR: J. CHEN	2006/09/01 2006/09/01 2006/09/08	DESCRIPTION REV	QUALITY SYMBOLS ▽=0 ▽=0	GENERAL TOLERANCES (UNLESS SPECIFIED)	DIMENSION STYLE <b>MM ONLY</b>	SCALE <b>4:1</b>	DESIGN UNITS <b>METRIC</b>	THIRD ANGLE PROJECTION																											
				<table border="1" style="width: 100%; border-collapse: collapse;"> <thead> <tr> <th></th> <th>mm</th> <th>INCH</th> </tr> </thead> <tbody> <tr> <td>4 PLACES</td> <td>± ---</td> <td>± ---</td> </tr> <tr> <td>3 PLACES</td> <td>± ---</td> <td>± ---</td> </tr> <tr> <td>2 PLACES</td> <td>± 0.15</td> <td>± ---</td> </tr> <tr> <td>1 PLACE</td> <td>± 0.25</td> <td>± ---</td> </tr> </tbody> </table>		mm	INCH	4 PLACES	± ---	± ---	3 PLACES	± ---	± ---	2 PLACES	± 0.15	± ---	1 PLACE	± 0.25	± ---	<table border="1" style="width: 100%; border-collapse: collapse;"> <thead> <tr> <th>DRAWN BY</th> <th>DATE</th> </tr> </thead> <tbody> <tr> <td>RICHARD</td> <td>'01/06/21</td> </tr> <tr> <th>CHECKED BY</th> <th>DATE</th> </tr> <tr> <td>VINCENT</td> <td>'01/06/21</td> </tr> <tr> <th>APPROVED BY</th> <th>DATE</th> </tr> <tr> <td>ERIC</td> <td>'01/06/21</td> </tr> </tbody> </table>	DRAWN BY	DATE	RICHARD	'01/06/21	CHECKED BY	DATE	VINCENT	'01/06/21	APPROVED BY	DATE	ERIC	'01/06/21	<b>1.27MM HIGH SPEED SERIAL PLUG VERTICAL TYPE</b>		
					mm	INCH																													
				4 PLACES	± ---	± ---																													
3 PLACES	± ---	± ---																																	
2 PLACES	± 0.15	± ---																																	
1 PLACE	± 0.25	± ---																																	
DRAWN BY	DATE																																		
RICHARD	'01/06/21																																		
CHECKED BY	DATE																																		
VINCENT	'01/06/21																																		
APPROVED BY	DATE																																		
ERIC	'01/06/21																																		
ANGULAR ± 3 °				MATERIAL NO.	DOCUMENT NO.	<b>MOLEX INCORPORATED</b>																													
DRAFT WHERE APPLICABLE MUST REMAIN WITHIN DIMENSIONS				SEE TABLE	SD-67491-002	SHEET NO. <b>2 OF 2</b>																													