

PLEASE CHECK WWW.MOLEX.COM FOR LATEST PART INFORMATION

Part Number: [0885272301](#)
Status: **Active**
Description: FC-to-ST, Multimode, 62.5/125µm, Duplex, 2.00mm (.079"), Standard Fiber Optic Cable Assembly, 2.0m (6.56')

Documents:

[Drawing \(PDF\)](#) [RoHS Certificate of Compliance \(PDF\)](#)

General

Product Family	Fiber Optic Assemblies
Series	88527
Connector to Connector	FC-to-ST
Mode	Multimode
Product Name	FC, ST

Physical

Cable Length	2.0m (6.56')
Cable Size	2.00mm (.079")
Fiber (Core/Cladding)	62.5/125µm
Single Ended	No
Wire/Cable Type	Duplex

Material Info

Reference - Drawing Numbers

Sales Drawing	SD-88527-023
---------------	--------------

EU RoHS

RoHS Compliant by Exemption
REACH SVHC Not Reviewed
Halogen-Free Status Not Reviewed

China RoHS



Need more information on product environmental compliance?

Email productcompliance@molex.com
For a multiple part number RoHS Certificate of Compliance, [click here](#)

Please visit the [Contact Us](#) section for any non-product compliance questions.

Search Parts in this Series
[88527Series](#)

7 6 5 4 3 2 1

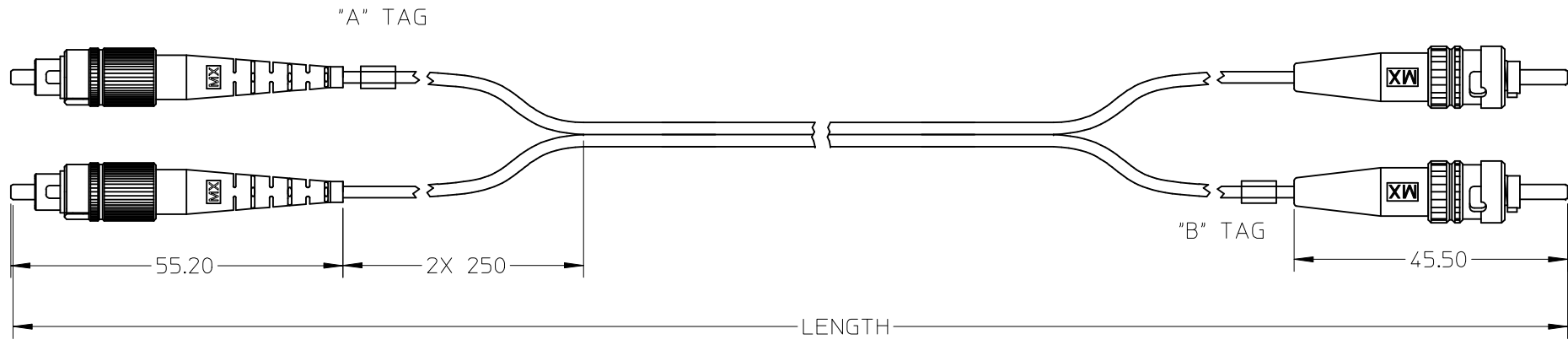

885272304	FC-ST DUP MM 62.5/125 2MM 10M	10000(+200/-0)
885272303	FC-ST DUP MM 62.5/125 2MM 5M	5000(+200/-0)
885272302	FC-ST DUP MM 62.5/125 2MM 3M	3000(+200/-0)
885272301	FC-ST DUP MM 62.5/125 2MM 2M	2000(+200/-0)
885272300	FC-ST DUP MM 62.5/125 2MM 1M	1000(+100/-0)
MX P/N	DESCRIPTION	LENGTH

NOTES:
 1. DUST CAPS ARE NOT SHOWN
 2. PER CHANNEL @ 850nm
 IL <= 0.50dB

ENTER DESCRIPTION EC NO: DG2009-0079 DRWN: XPCHEN CHKD: APPR: JOWANG	2008/11/10 2008/11/10 2008/11/12	QUALITY SYMBOLS ▽=0 ◻=0	GENERAL TOLERANCES (UNLESS SPECIFIED)		DIMENSION STYLE MM ONLY		SCALE ---	DESIGN UNITS METRIC	THIRD ANGLE PROJECTION			
				mm	INCH	DRAWN BY XP	DATE 2008/10/10	TITLE FC-ST DUP MM 62.5 2MM				
			4 PLACES	±---	±---	CHECKED BY LISA	DATE 2008/10/10	MOLEX INCORPORATED DOCUMENT NO. SD-88527-023 SHEET NO. 1 OF 00				
			3 PLACES	±---	±---	APPROVED BY JOHNNY	DATE 2008/10/10					
			2 PLACES	±---	±---	ANGULAR ±---°		MATERIAL NO. ENTER PART				
1 PLACE	±---	±---	DRAFT WHERE APPLICABLE MUST REMAIN WITHIN DIMENSIONS		SIZE A4 THIS DRAWING CONTAINS INFORMATION THAT IS PROPRIETARY TO MOLEX INCORPORATED AND SHOULD NOT BE USED WITHOUT WRITTEN PERMISSION							

6 5 4 3 2 1