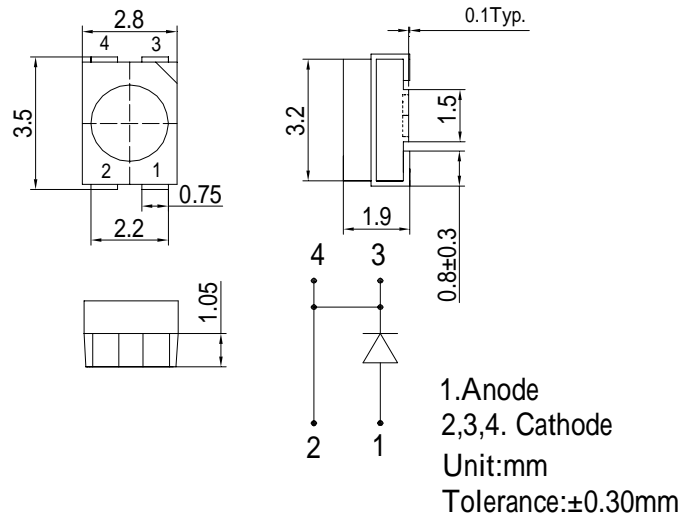

■Features

- Highest Luminous PLCC4 Power Top SMD LEDs
- Super energy efficiency
- Superior Weather-resistance
- Superior ESD protection
- No UV

■Applications

- Read lights (car, bus, aircraft)
- Portable (flashlight, bicycle)
- Bollards / Security / Garden
- Traffic signaling / Beacons
- In door / Out door Commercial lights
- Automotive Ext

■Outline Dimension

■Absolute Maximum Rating

(Ta=25)

Item	Symbol	Value	Unit
DC Forward Current	I_F	120	mA
Pulse Forward Current*	I_{FP}	200	mA
Reverse Voltage	V_R	5	V
Power Dissipation	P_D	480	mW
Operating Temperature	T_{opr}	-30 ~ +85	
Storage Temperature	T_{stg}	-40~ +100	
Lead Soldering Temperature	T_{sol}	260 /5sec	-

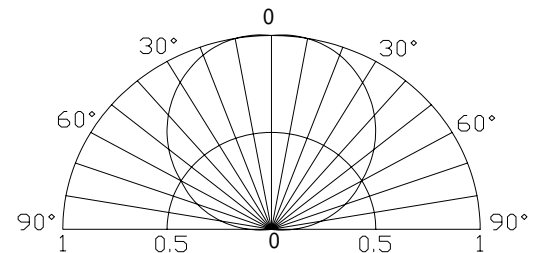
*Pulse width Max.10ms Duty ratio max 1/10

■Directivity

Electrical -Optical Characteristics

(Ta=25)

Item	Symbol	Condition	Min.	Typ.	Max.	Unit
DC Forward Voltage	V_F	$I_F=70mA$	2.0	2.5	3.0	V
DC Reverse Current	I_R	$V_R=5V$	-	-	10	μA
Domi Wavelength*	λ_D	$I_F=70mA$	585	590	595	nm
Luminous Intensity*	I_v	$I_F=70mA$	-	4500	-	mcd
50% Power Angle	$2\theta_{1/2}$	$I_F=70mA$	-	120	-	deg

 *1 Tolerance of dominant wavelength is $\pm 1nm$

 *2 Tolerance of luminous intensity is $\pm 15\%$