

Synchronous Step-Down DC/DC Converter with Built-In LDO Regulator In Parallel Plus Voltage Detector

■ GENERAL DESCRIPTION

The XC9511 series consists of a step-down DC/DC converter and a high-speed LDO regulator connected in parallel with the DC/DC converter's output. A voltage detector is also built-in. Since the input for the LDO voltage regulator block comes from the input power supply, it is suited for use with various applications.

The DC/DC converter block incorporates a P-channel driver transistor and a synchronous N-channel switching transistor. With an external coil, diode and two capacitors, the XC9511 can deliver output currents up to 800mA at efficiencies over 90%. The XC9511 is designed for use with small ceramic capacitors.

A choice of three switching frequencies are available, 300 kHz, 600 kHz, and 1.2 MHz. Output voltage settings for the DC/DC and VR are set-up internally in 100mV steps within the range of 0.9V to 4.0V ($\pm 2.0\%$). For the VD, the range is of 0.9V to 5.0V ($\pm 2.0\%$). The soft start time of the series is internally set to 5ms. With the built-in U.V.L.O. (Under Voltage Lock Out) function, the internal P-channel driver transistor is forced OFF when input voltage becomes 1.4 V or lower.

■ APPLICATIONS

- CD-R / RW, DVD
- HDD
- PDAs, portable communication modem
- Palmtop computers
- Cellular phones
- Cameras, video recorders

■ FEATURES

DC/DC Converter with Built-in LDO and VD Function

- Input Voltage Range** : 2.4V ~ 6.0V
- Low ESR Capacitor** : Ceramic capacitor compatible
- VD Function** : Three VD sensing Options for either VDD, DCOUT, or VROUT
- Package** : SOP-8

<DC/DC Converter Block>

- Output Voltage Range** : 0.9V ~ 4.0V (Accuracy $\pm 2\%$)
- Output Current** : 800mA
- Control Method** : PWM or PWM/PFM Selectable
- Oscillation Frequency** : 300kHz, 600kHz, 1.2MHz

<Regulator Block>

- Regulator Input** : Parallel Input to DC/DC converter
- Output Voltage Range** : 0.9V ~ 4.0V (Accuracy $\pm 2\%$)
- Current Limit** : 600mA
- Dropout Voltage** : 160mV@I_{OUT}=200mA (V_{OUT}=2.8V)
- High Ripple Rejection** : 60dB @1kHz (V_{OUT}=2.8V)

■ TYPICAL APPLICATION CIRCUIT

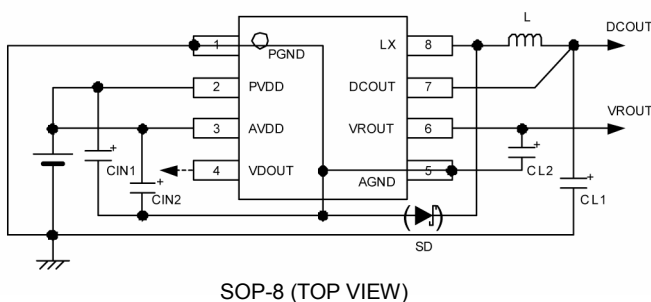

* Please refer to the typical application circuit when external components are selected.

■ TYPICAL PERFORMANCE CHARACTERISTICS

XC9511Axxx
 $V_{IN}=5.0V$, $T_{opr}=25^{\circ}C$, L : $4.7 \mu H$ (CDRH4D28C)
 CIN: $4.7 \mu F$ (ceramic), CL1: $10 \mu F$ (ceramic), CL2: $4.7 \mu F$ (ceramic)

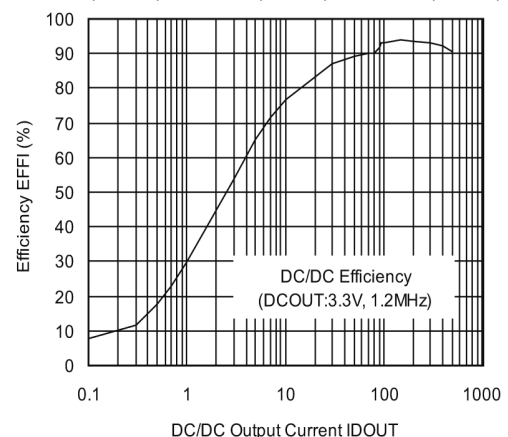

PIN CONFIGURATION

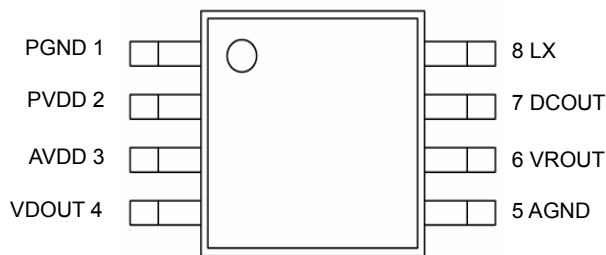

SOP-8 (TOP VIEW)

PIN ASSIGNMENT

PIN NUMBER	PIN NAME	FUNCTION
1	PGND	Power Ground
2	PVDD	Power Supply 1
3	AVDD	Power Supply 2
4	VDOUT	VD Output
5	AGND	Analog Ground
6	VROUT	VR Output
7	DCOUT	DC/DC Output
8	LX	Switch

PRODUCT CLASSIFICATION

Ordering Information

XC9511①②③④⑤⑥ The input for the voltage regulator block comes from VDD

DESIGNATOR	DESCRIPTION	SYMBOL	DESCRIPTION
①	Control Methods and the VD Sense Pin	As chart below	: -
② ③	Setting Voltage & Specifications	Internal standard	: Setting voltage and specifications of each DC/DC, VR, and VD (Based on the internal standard)
④	DC/DC Oscillation Frequency	3	: 300kHz
		6	: 600kHz
		C	: 1.2MHz
⑤	Package	S	: SOP-8
⑥	Device Orientation	R	: Embossed tape, standard feed
		L	: Embossed tape, reverse feed

Control Methods and VD SENSE Pin

SERIES	①	DC/DC CONTROL METHODS	VD SENSE
XC9511	A	PWM control	VDD
	B		DCOUT
	C		VROUT
	D	PFM/PWM Automatic Switch	VDD
	E		DCOUT
	F		VROUT

■ BLOCK DIAGRAM

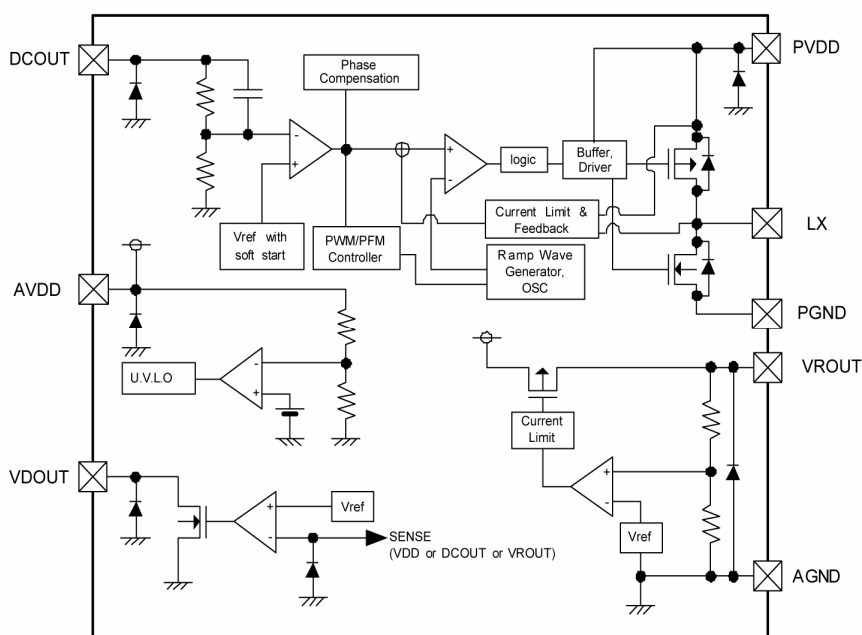

* Diodes shown in the above circuit are protective diodes

■ ABSOLUTE MAXIMUM RATINGS

Ta = 25°C

PARAMETER	SYMBOL	RATINGS	UNIT
AVDD Pin Voltage	AVDD	- 0.3 ~ 6.5	V
PVDD Pin Voltage	PVDD	AVDD - 0.3 ~ AVDD + 0.3	V
DCOUT Pin Voltage	DCOUT	- 0.3 ~ AVDD + 0.3	V
VROUT Pin Voltage	VROUT	- 0.3 ~ AVDD + 0.3	V
VROUT Pin Current	IROUT	800	mA
VDOUT Pin Voltage	VDOUT	- 0.3 ~ VDD + 0.3	V
VDOUT Pin Current	IVD	50	mA
Lx Pin Voltage	Lx	- 0.3 ~ VDD + 0.3	V
Lx Pin Current	ILx	±1300	mA
Power Dissipation	SOP-8 Pd	650	mW
Operating Temperature Range	Topr	- 40 ~ + 85	°C
Storage Temperature Range	Tstg	- 55 ~ + 125	°C

(*) When implemented on a glass epoxy PCB.

ELECTRICAL CHARACTERISTICS

XC9511xxxCSx

Common Characteristics

Topr=25°C

PARAMETER	SYMBOL	CONDITIONS	MIN.	TYP.	MAX.	UNITS	CIRCUIT
Supply Current 1	IDD1	VIN=CE=DCOUT=5.0V	-	250	310	μA	1
Supply Current 2	IDD2	VIN=CE=5.0V, DCOUT=0V	-	300	360	μA	1
Input Voltage Range	VIN		2.4	-	6.0	V	-

DC/DC Converter (1.5V product)

Topr=25°C

PARAMETER	SYMBOL	CONDITIONS	MIN.	TYP.	MAX.	UNITS	CIRCUIT
Output Voltage	DCOUT(E)	Connected to the external components IDOUT=30mA	1.470	1.500	1.530	V	3
Oscillation Frequency	Fosc	Connected to the external components IDOUT=10mA	1.02	1.20	1.38	MHz	3
Maximum Duty Ratio	MAXDUTY	DCOUT=0V	100	-	-	%	4
Minimum Duty Ratio	MINDUTY	DCOUT=VIN	-	-	0	%	4
PFM Duty Ratio * XC9511D/E/F	PFMDUTY	Connected to the external components No load	21	30	38	%	3
U.V.L.O. Voltage (*1)	VUVLO	Connected to the external components	1.00	1.40	1.78	V	3
LX SW 'High' ON Resistance (*2)	RLXH	DCOUT=0V, LX=VIN-0.05V	-	0.5	0.9	Ω	5
LX SW 'Low' ON Resistance	RLXL	Connected to the external components, VIN=5.0V	-	0.5	0.9	Ω	3
LX SW 'High' Leak Current (*11)	IleakH	VIN=LX=6.0V, CE=0V	-	0.05	1.00	μA	11
LX SW 'Low' Leak Current (*11)	IleakL	VIN=6.0V, LX=CE=0V	-	0.05	1.00	μA	11
Maximum Output Current	I _{max1}	Connected to the external components	800	-	-	mA	3
Current Limit (*8)	I _{lim1}		1.0	1.1	-	A	6
Efficiency (*3)	EFFI	Connected to the external components IDOUT=100mA	-	90	-	%	3
Output Voltage Temperature Characteristics	$\frac{\Delta DCOUT}{\Delta Topr \cdot DCOUT}$	IDOUT=30mA -40°C ≤ Topr ≤ 85°C	-	±100	-	ppm/ °C	3
Soft-Start Time	TSS	Connected to the external components, CE=0V → VIN, IDOUT=1mA	2	5	10	ms	3
Latch Time (*4, 9)	Tlat	Connected to the external components, VIN=CE=5.0V, Short DCOUT by 1Ω resistor	-	8	25	ms	10

■ ELECTRICAL CHARACTERISTICS (Continued)

XC9511xxxCSx (Continued)

● Regulator (3.3V product)

Topr=25°C

PARAMETER	SYMBOL	CONDITIONS	MIN.	TYP.	MAX.	UNITS	CIRCUIT
Output Voltage	V _{ROUT(E)}	I _{ROUT} =30mA	3.234	3.300	3.366	V	2
Maximum Output Current	I _{max2}		400	-	-	mA	2
Load Regulation	Δ V _{ROUT}	1mA ≤ I _{ROUT} ≤ 100mA	-	15	50	mV	2
Dropout Voltage 1 (*5)	V _{dif 1}	I _{ROUT} =100mA	-	50	110	mV	2
Dropout Voltage 2	V _{dif 2}	I _{ROUT} =200mA	-	100	200	mV	2
Line Regulation	$\frac{\Delta V_{ROUT}}{\Delta V_{IN} \cdot V_{ROUT}}$	I _{ROUT} =30mA V _{ROUT(T)} +1V ≤ V _{IN} ≤ 6V	-	0.05	0.25	%/V	2
Current Limit	I _{lim2}	V _{ROUT} =V _{ROUT(E)} x 0.9	480	600	-	mA	7
Short-Circuit Current	I _{short}	V _{ROUT} =V _{SS}	-	30	-	mA	7
Ripple Rejection Rate	PSRR	V _{IN} ={V _{OUT(T)} +1.0} V _{DC} +0.5Vp-pAC, I _{ROUT} =30mA, f=1kHz	-	60	-	dB	12
Output Voltage Temperature Characteristics	$\frac{\Delta V_{ROUT}}{\Delta T_{opr} \cdot V_{ROUT}}$	I _{ROUT} =30mA -40°C ≤ Topr ≤ 85°C	-	±100	-	ppm/ °C	2

● Detector (2.7V product)

Topr=25°C

PARAMETER	SYMBOL	CONDITIONS	MIN.	TYP.	MAX.	UNITS	CIRCUIT
Detect Voltage	V _{DF(E)}	CE=0V	2.646	2.700	2.754	V	8
Hysteresis Range	V _{HYS}	V _{HYS} =[V _{DR(E)} ⁽¹⁰⁾ - V _{DF(E)}] / V _{DF(E)} x 100	2	5	8	%	8
VD Output Current	I _{VD}	V _{DO} UT=0.5V, CE=0V	1	-	-	mA	9
Output Voltage Temperature Characteristics	$\frac{\Delta V_{DF}}{\Delta T_{opr} \cdot V_{DF}}$	-40°C ≤ Topr ≤ 85°C	-	±100	-	ppm/ °C	8

Test conditions: Unless otherwise stated:

DC/DC : V_{IN}=3.6V [DC_{OUT}:1.5V]

VR: V_{IN} = 4.3V (V_{IN}=V_{ROUT(T)} + 1.0V)

VD: V_{IN}=5.0V

Common conditions for all test items: CE=V_{IN}, MODE=0V

* V_{ROUT(T)} : Setting output voltage

NOTE:

*1: Including hysteresis operating voltage range.

*2: ON resistance (Ω)= 0.05 (V) / I_{LX} (A).

*3: EFF1 = { (Output Voltage x Output Current) / (Input Voltage x Input Current) } x 100

*4: Time until it short-circuits DC_{OUT} with GND through 1Ω of resistance from a state of operation and is set to DC_{OUT}=0V from current limit pulse generating.

*5: V_{dif} = (V_{IN1}⁽⁶⁾ - V_{ROUT1}⁽⁷⁾)

*6: V_{IN 1} = The input voltage when V_{ROUT1} appears as input voltage is gradually decreased.

*7: V_{ROUT1} = A voltage equal to 98% of the output voltage whenever an amply stabilized I_{OUT} {V_{ROUT(T)} + 1.0V} is input.

*8: Current limit = When V_{IN} is low, limit current may not be reached because of voltage falls caused by ON resistance or serial resistance of coils.

*9: Integral latch circuit=latch time may become longer and latch operation may not work when V_{IN} is 3.0V or more.

*10: V_{DR(E)} = VD release voltage

*11: When temperature is high, a current of approximately 5.0 μA (maximum) may leak.

*12: When using the IC with a regulator output at almost no load, a capacitor should be placed as close as possible between AVDD and AGND (C_{IN2}), connected with low impedance. Please also see the recommended pattern layout on page 13 for your reference. Should it not be possible to place the input capacitor nearby, the regulated output level may increase up to the V_{DD} level while the load of the DC/DC converter increases and the regulator output is at almost no load.

TEST CIRCUITS

Circuit 1 Supply Current

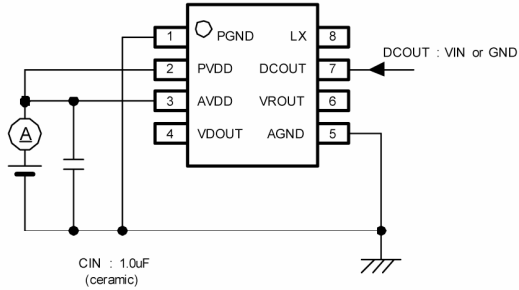

Circuit 2 Output Voltage (VR), Load Regulation, Dropout Voltage, Maximum Output Current

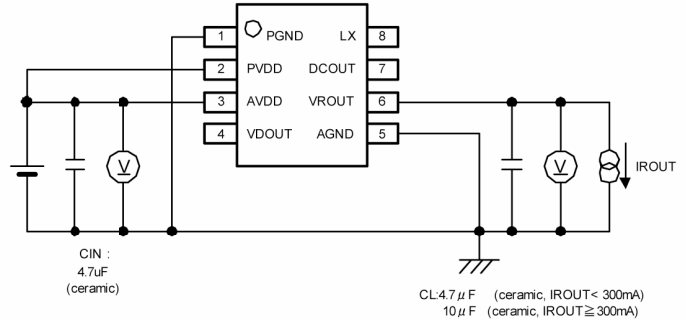

Circuit 3 Output Voltage (DC/DC) Oscillation Frequency, U.V.L.O. Voltage, Soft start Time, Maximum Output Current, Efficiency, (PFM Duty Cycle),

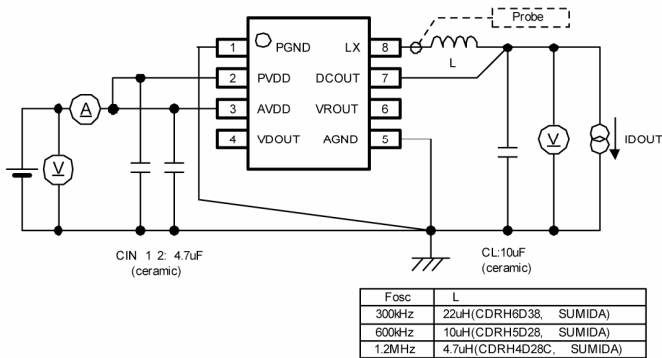

Circuit 4 Minimum Duty Cycle, Maximum Duty Cycle

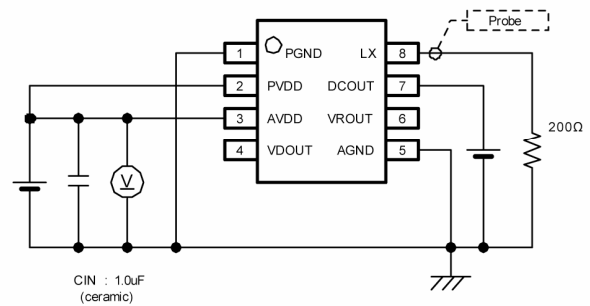

Circuit 5 Lx ON Resistance

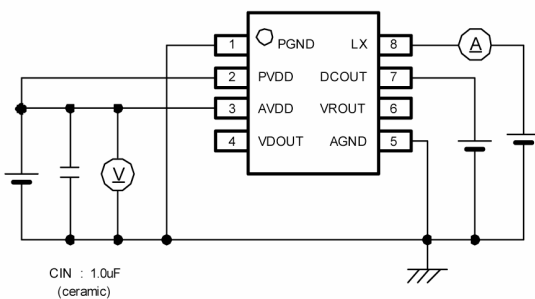

Circuit 6 Current Limit 1 (DC/DC)

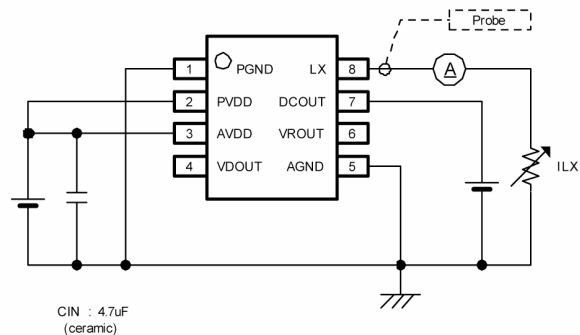

TEST CIRCUITS (Continued)

Circuit 7 Current Limit 2 (VR), Short Current (VR)

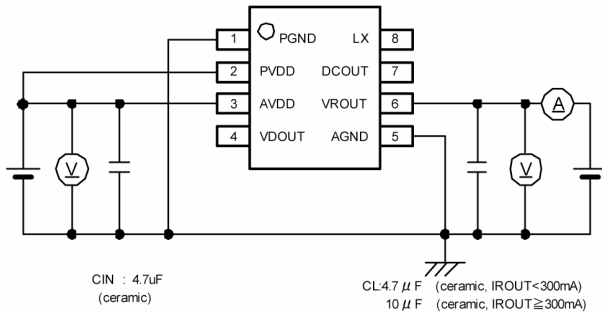

Circuit 8 Detect Voltage, Release Voltage (Hysteresis Range)

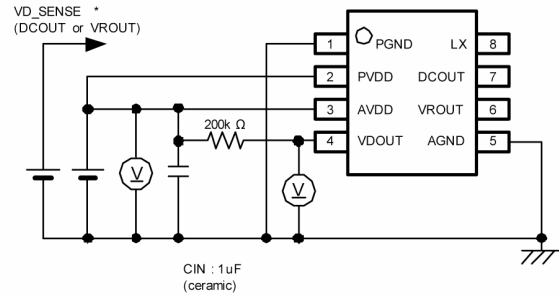

* For the measurement of the VDD_Sense products, the input voltage was controlled.

Circuit 9 VD Output Current

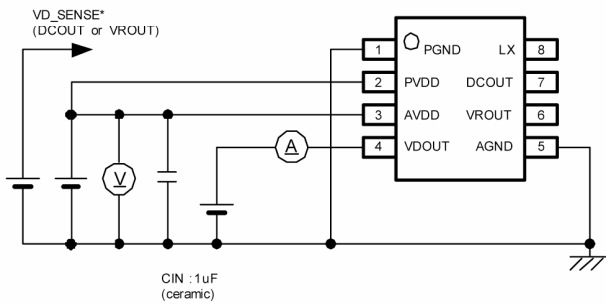

* For the measurement of the VDD_Sense products, the input voltage was controlled.

Circuit 10 Latch Time

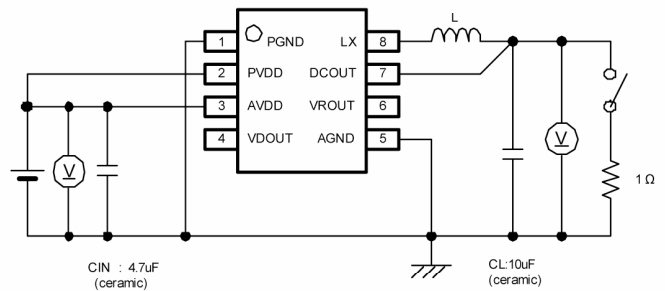

Fosc	L
300kHz	22µH(CDRH6D38, SUMIDA)
600kHz	10µH(CDRH5D28, SUMIDA)
1.2MHz	4.7µH(CDRH4D28C, SUMIDA)

Circuit 11 Off-Leak

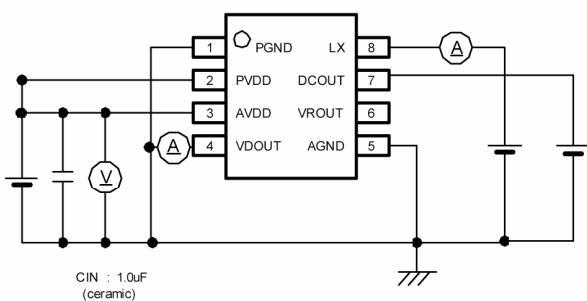

Circuit 12 Ripple Rejection Rate

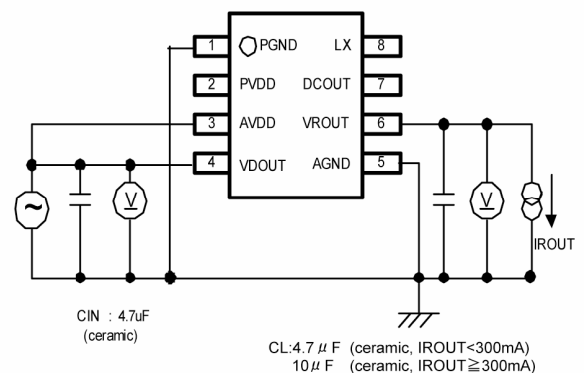

TYPICAL APPLICATION CIRCUIT

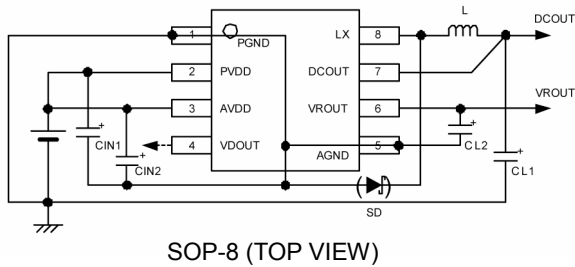

FOSC	L
1.2MHz	4.7 μ H (CDRH4D28C, SUMIDA)
600KHz	10 μ H (CDRH5D28, SUMIDA)
300kHz	22 μ H (CDRH6D28, SUMIDA)

CIN	CL1	CL2 *2	
4.7 μ F (ceramic, TAIYO YUDEN)	10 μ F (ceramic, TAIYO YUDEN)	IROUT < 300mA	4.7 μ F (ceramic, TAIYO YUDEN)
		IROUT \geq 300mA	10 μ F (ceramic, TAIYO YUDEN)

SD *1: XB0ASB03A1BR (TOREX)

*1 The DC/DC converter of the XC9511 series automatically switches between synchronous / non-synchronous. The Schottky diode is not normally needed. However, in cases where high efficiency is required when using the DC/DC converter during light load while in non-synchronous operation, please connect a Schottky diode externally.

*2 Please pay much attention when external components are selected as recommended value of CL2 will be changed by the load current.

OPERATIONAL EXPLANATION

The XC9511 series consists of a synchronous step-down DC/DC converter, a high speed LDO voltage regulator, and a voltage detector.

DC/DC Converter

The series consists of a reference voltage source, ramp wave circuit, error amplifier, PWM comparator, phase compensation circuit, output voltage adjustment resistors, driver transistor, synchronous switch, current limiter circuit, U.V.L.O. circuit and others. The series ICs compare, using the error amplifier, the voltage of the internal voltage reference source with the feedback voltage from the Vout pin through split resistors. Phase compensation is performed on the resulting error amplifier output, to input a signal to the PWM comparator to determine the turn-on time during PWM operation. The PWM comparator compares, in terms of voltage level, the signal from the error amplifier with the ramp wave from the ramp wave circuit, and delivers the resulting output to the buffer driver circuit to cause the Lx pin to output a switching duty cycle. This process is continuously performed to ensure stable output voltage. The current feedback circuit monitors the P-channel MOS driver transistor current for each switching operation, and modulates the error amplifier output signal to provide multiple feedback signals. This enables a stable feedback loop even when a low ESR capacitor, such as a ceramic capacitor, is used, ensuring stable output voltage.

<Reference Voltage Source>

The reference voltage source provides the reference voltage to ensure stable output voltage of the DC/DC converter.

<Ramp Wave Circuit>

The ramp wave circuit determines switching frequency. The frequency is fixed internally and can be selected from 300kHz, 600 kHz and 1.2 MHz. Clock pulses generated in this circuit are used to produce ramp waveforms needed for PWM operation, and to synchronize all the internal circuits.

<PWM/PFM>

The XC9511A to C series are PWM control, while the XC9511D to F series can be automatically switched to PWM/PFM control. The PWM mode of the XC9511A to C series are controlled on a specified frequency from light loads through to heavy loads. Since the frequency is specified, the composition of a noise filter etc. becomes easy. However, the efficiency at the time of the light load may become low. The XC9511D to F series can switch to PWM/PFM automatic switching control. With the automatic PWM/PFM switching control function, the series ICs are automatically switched from PWM control to PFM control mode under light load conditions. The series cannot control only PFM mode. If during light load conditions the coil current becomes discontinuous and on-time rate falls lower than 30%, the PFM circuit operates to output a pulse with 30% of a fixed on-time rate from the Lx pin. During PFM operation with this fixed on-time rate, pulses are generated at different frequencies according to conditions of the moment. This causes a reduction in the number of switching operations per unit of time, resulting in efficiency improvement under light load conditions. However, since pulse output frequency is not constant, consideration should be given if a noise filter or the like is needed. Necessary conditions for switching to PFM operation depend on input voltage, load current, coil value and other factors.

■ OPERATIONAL EXPLANATION (Continued)

<Synchronous / Non-synchronous>

The XC9511 series automatically switches between synchronous / non-synchronous according to the state of the DC/DC converter. Highly efficient operations are achievable using the synchronous mode while the coil current is in a continuous state. The series enters non-synchronous operation when the built-in N-ch switching transistor for synchronous operation is shutdown, which happens when the load current becomes low and the operation changes to a discontinuous state. The IC can operate without an external schottky diode because the parasitic diode in the N-ch switching transistor provides the circuit's step-down operation. However, since VF of the parasitic diode is a high 0.6V, the efficiency level during non-synchronous operation shows a slight decrease. Please use an external Schottky diode if high efficiency is required during light load current.

● Continuous Mode: Synchronous

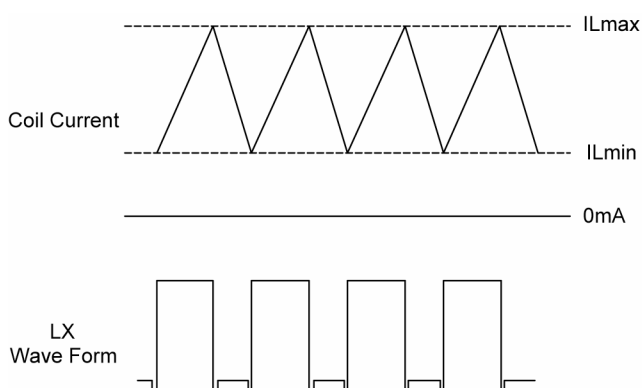

● Discontinuous Mode: Non-Synchronous

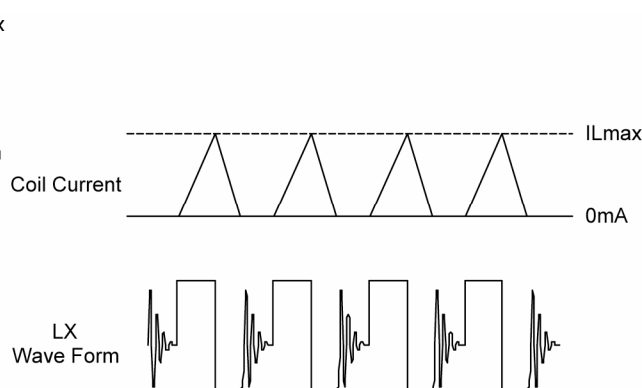

<Current Limit>

The current limiter circuit of the XC9511 series monitors the current flowing through the P-channel MOS driver transistor connected to the Lx pin and features a combination of the constant-current type current limit mode and the operation suspension mode.

- ① When the driver current is greater than a specific level, the constant-current type current limit function operates to turn off the pulses from the Lx pin at any given timing.
- ② When the driver transistor is turned off, the limiter circuit is then released from the current limit detection state.
- ③ At the next pulse, the driver transistor is turned on. However, the transistor is immediately turned off in the case of an over current state.
- ④ When the over current state is eliminated, the IC resumes its normal operation.

The IC waits for the over current state to end by repeating the steps ① through ③. If an over current state continues for 8msec* and the above three steps are repeatedly performed, the IC performs the function of latching the OFF state of the driver transistor, and goes into operation suspension mode. Once the IC is in suspension mode, operations can be resumed by either turning the IC off via the CE pin, or by restoring power to the VIN pin. The suspension mode does not mean a complete shutdown, but a state in which pulse output is suspended; therefore, the internal circuitry remains in operation. The constant-current type current limit of the XC9511 series can be set at 1.1A.

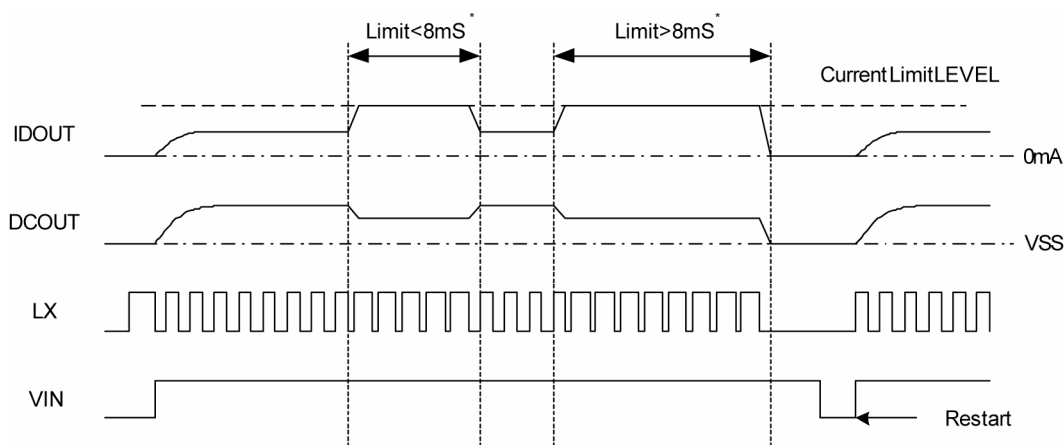

*1.2MHz Typical

■ OPERATIONAL EXPLANATION (Continued)

<U.V.L.O. Circuit>

When the V_{IN} pin voltage becomes 1.4 V or lower, the P-channel output driver transistor is forced OFF to prevent false pulse output caused by unstable operation of the internal circuitry. When the V_{IN} pin voltage becomes 1.8 V or higher, switching operation takes place. By releasing the U.V.L.O. function, the IC performs the soft start function to initiate output startup operation. The soft start function operates even when the V_{IN} pin voltage falls momentarily below the U.V.L.O. operating voltage. The U.V.L.O. circuit does not cause a complete shutdown of the IC, but causes pulse output to be suspended; therefore, the internal circuitry remains in operation.

● High Speed LDO Voltage Regulator

The voltage regulator block of the XC9511 series consists of a reference voltage source, error amplifier, and current limiter circuit. The voltage divided by split resistors is compared with the internal reference voltage by the error amplifier. The P-channel MOSFET, which is connected to the V_{ROUT} pin, is then driven by the subsequent output signal. The output voltage at the V_{ROUT} pin is controlled and stabilized by a system of negative feedback. A stable output voltage is achievable even if used with low ESR capacitors as a phase compensation circuit is built-in.

<Reference Voltage Source>

The reference voltage source provides the reference voltage to ensure stable output voltage of the regulator.

<Error Amplifier>

The error amplifier compares the reference voltage with the signal from V_{OUT} , and the amplifier controls the output of the Pch driver transistor.

<Current Limit Circuit>

The voltage regulator block includes a combination of a constant current limiter circuit and a foldback circuit. The voltage regulator senses output current of the built-in P channel output driver transistor inside. When the load current reaches the current limit level, the current limiter circuit operates and the output voltage of the voltage regulator block drops. As a result of this drop in output voltage, the foldback circuit operates, output voltage drops further and the load current decreases. When the V_{ROUT} and GND pin are shorted, the load current of about 30mA flows.

● Voltage Detector

The detector block of the XC9511 series detects output voltage from the V_{DOUT} pin while sensing either V_{DD} , D_{COUT} , or V_{ROUT} internally. (N channel Open Drain Type)

■ NOTES ON USE

● Application Information

1. The XC9511 series is designed for use with a ceramic output capacitor. If, however, the potential difference between dropout voltage or output current is too large, a ceramic capacitor may fail to absorb the resulting high switching energy and oscillation could occur on the output. If the input-output potential difference is large, connect an electrolytic capacitor in parallel to compensate for insufficient capacitance.
2. Spike noise and ripple voltage arise in a switching regulator as with a DC/DC converter. These are greatly influenced by external component selection, such as the coil inductance, capacitance values, and board layout of external components. Once the design has been completed, verification with actual components should be done.
3. When the difference between V_{IN} and V_{OUT} is large in PWM control, very narrow pulses will be outputted, and there is the possibility that some cycles may be skipped completely.
4. When the difference between V_{IN} and V_{OUT} is small, and the load current is heavy, very wide pulses will be outputted and there is the possibility that some cycles may be skipped completely: in this case, the Lx pin may not go low at all.

● DC/DC Waveform (3.3V, 1.2MHz)

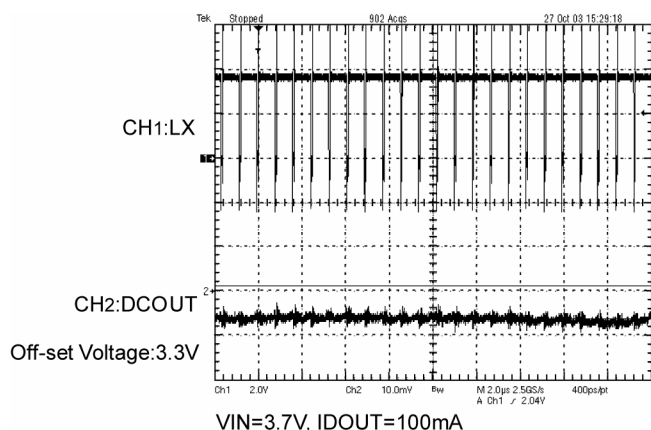

< External Components >
 L:4.7 μ H(CDRH4D28C,SUMIDA)
 CIN:4.7 μ F(ceramic)
 CL:10 μ F(ceramic)

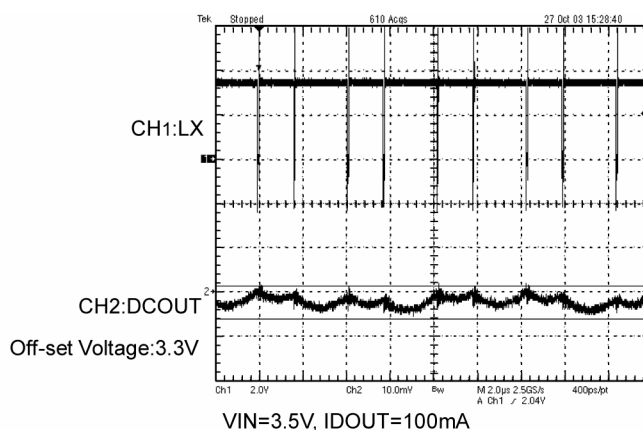

< External Components >
 L:4.7 μ H(CDRH4D28C,SUMIDA)
 CIN:4.7 μ F(ceramic)
 CL:10 μ F(ceramic)

5. The IC's DC/DC converter operates in synchronous mode when the coil current is in a continuous state and non-synchronous mode when the coil current is in a discontinuous state. In order to maintain the load current value when synchronous switches to non-synchronous and vice versa, a ripple voltage may increase because of the repetition of switching between synchronous and non-synchronous. When this state continues, the increase in the ripple voltage stops. To reduce the ripple voltage, please increase the load capacitance value or use a schottky diode externally. When the current used becomes close to the value of the load current when synchronous switches to non-synchronous and vice versa, the switching current value can be changed by changing the coil inductance value. In case changes to coil inductance are to values other than the recommended coil inductance values, verification with actual components should be done.

$$I_{cs} = \frac{(V_{IN} - D_{cOUT}) \times OnDuty}{L \times F_{osc}}$$

I_{cs} : Switching current from synchronous rectification to non-synchronous rectification
 $OnDuty$: $OnDuty$ ratio of P-ch driver transistor (=step down ratio : D_{cOUT} / V_{IN})
 L : Coil inductance value
 F_{osc} : Oscillation Frequency
 $IDOUT$: The DC/DC load current

NOTES ON USE (Continued)

Application Information (Continued)

6. When the XC9511D to F series operate in PWM/PFM automatic switching control mode, the reverse current may become quite high around the load current value when synchronous switches to non-synchronous and vice versa (also refer to no. 5). Under this condition, switching synchronous rectification and non-synchronous rectification may be repeated because of the reverse current, and the ripple voltage may be increased to 100mV or more. The reverse current is the current that flows in the PGND direction through the N-ch driver transistor from the coil. The conditions which cause this operation are as follows.

$PFM\ Duty < Step\ down\ ratio = DCOUT / VIN \times 100\ (\%)$
 PFM Duty: 30% (TYP.)

Please use XC9511A to C types (PWM control) in cases where the load current value of the DC/DC converter is close to synchronous.

DC/DC Waveform (1.8V, 600kHz) @ VIN=6.0V

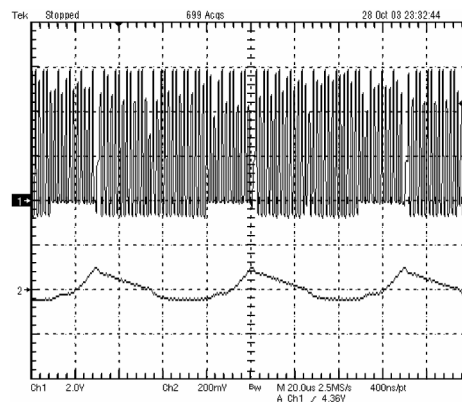

VIN=6.0V, IDOUT=50mA

< External Components >

L:10 μ H(CDRH5D28,SUMIDA)

CIN:4.7 μ F(ceramic)

CL:10 μ F(ceramic)

Step-down ratio: 1.8V / 6.0V = 30% <PFM Duty 31%>

7. With the DC/DC converter of the IC, the peak current of the coil is controlled by the current limit circuit. Since the peak current increases when dropout voltage or load current is high, current limit starts operating, and this can lead to instability. When peak current becomes high, please adjust the coil inductance value and fully check the circuit operation. In addition, please calculate the peak current according to the following formula:

$$Peak\ current : I_{pk} = (V_{IN} - DCOUT) \times OnDuty / (2 \times L \times F_{osc}) + IDOUT$$

8. When the peak current, which exceeds limit current flows within the specified time, the built-in driver transistor is turned off (the integral latch circuit). During the time until it detects limit current and before the built-in transistor can be turned off, the current for limit current flows; therefore, care must be taken when selecting the rating for the coil or the Schottky diode.
9. When VIN is low, limit current may not be reached because of voltage falls caused by ON resistance or serial resistance of the coil.
10. In the integral latch circuit, latch time may become longer and latch operation may not work when VIN is 3.0V or more.
11. Use of the IC at voltages below the recommended voltage range may lead to instability.
12. This IC and the external components should be used within the stated absolute maximum ratings in order to prevent damage to the device.
13. When using IC with a regulator output at almost no load, a capacitor should be placed as close as possible between AVDD and AGND (CIN2), connected with low impedance. Please also see the recommended pattern layout for your reference. Should it not be possible to place the input capacitor nearby, the regulated output level may increase up to the VDD level while the load of the DC/DC converter increases and the regulator output is at almost no load.

■ NOTES ON USE (Continued)

● Application Information (Continued)

14. Should the bi-directional load current of the synchronous DC/DC converter and the regulator become large, please be careful of the power dissipation when in use. Please calculate power dissipation by using the following formula.

$$Pd = Pd_{DC/DC} + Pd_{VR}$$

DC/DC power dissipation (when in synchronous operation): $Pd_{DC/DC} = I_{DOUT}^2 \times R_{ON}$

VR power dissipation: $Pd_{VR} = (V_{IN} - V_{ROUT}) \times I_{ROUT}$

R_{ON} : ON resistance of the built-in driver transistor to the DC/DC (= 0.5Ω <TYP.>)

$$R_{ON} = R_{pon} \times PchOnDuty / 100 + R_{non} \times (1 - PchOnDuty / 100)$$

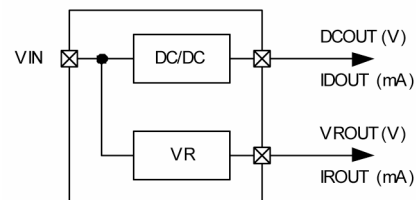

15. The voltage detector circuit built-in the XC9511 series internally monitor the V_{DD} pin voltage, the DC/DC output pin voltage and VR output pin voltage. For the XC9511B/C/E/F series, which voltage detector circuit monitors the DC/DC output pin voltage and the VR output pin voltage, please determine the detect voltage value (V_{DF}) by the following equation.

$$V_{DF} \leq (\text{Setting voltage on both the } DCOUT \text{ voltage and the } VROUT \text{ voltage}) \times 85\%^*$$

* An assumed value of tolerance among the DCOUT voltage, the VROUT voltage, and the VD release voltage (The VD detect voltage and hysteresis range).

● Instructions on Pattern Layout

- In order to stabilize V_{IN} 's voltage level, we recommend that a by-pass capacitor (C_{IN}) be connected as close as possible to the AV_{DD} & $AGND$ pins. Should it not be possible to place the input capacitors nearby, the regulated output level may increase because of the switching noise of the DC/DC converter.
- Please mount each external component as close to the IC as possible.
- Wire external components as close to the IC as possible and use thick, short connecting traces to reduce the circuit impedance.
- Make sure that the PCB GND traces are as thick as possible, as variations in ground potential caused by high ground currents at the time of switching may result in instability of the DC/DC converter and have adverse influence on the regulator output.
- If using a Schottky diode, please connect the anode side to the $AGND$ pin through C_{IN} . Characteristic degradation caused by the noise may occur depending on the arrangement of the Schottky diode.
- Please use the AV_{DD} and PV_{DD} pins with the same electric potential.

<SOP-8 Reference pattern layout>

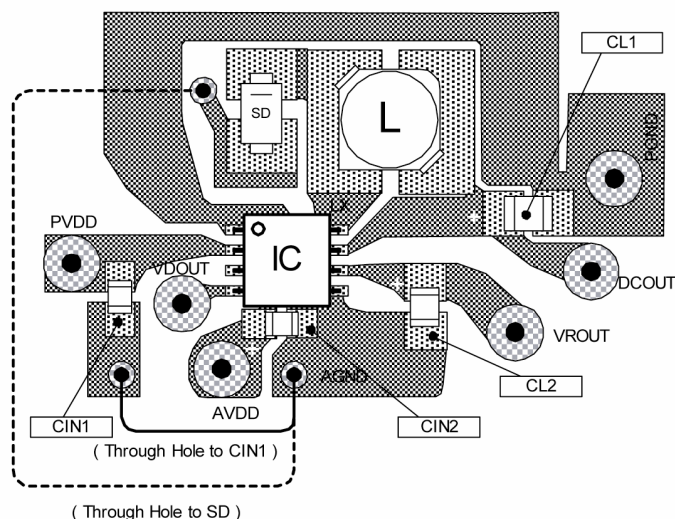

TYPICAL PERFORMANCE CHARACTERISTICS

(A) DC/DC CONVERTER

(1) Efficiency vs. Output Current

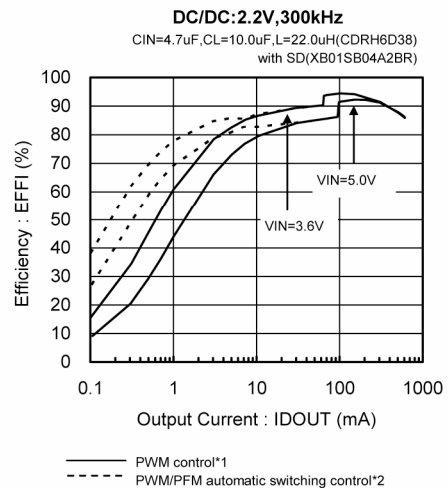
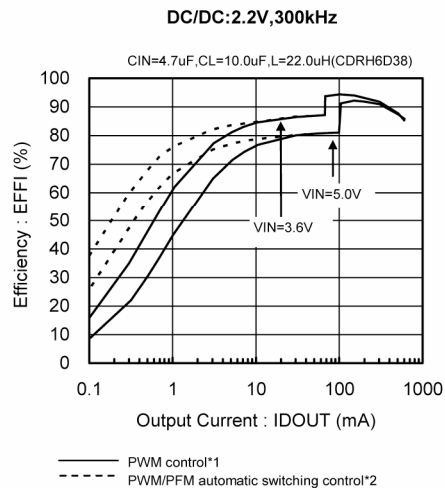
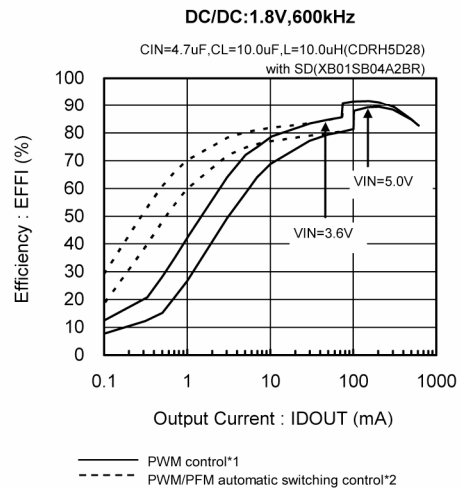
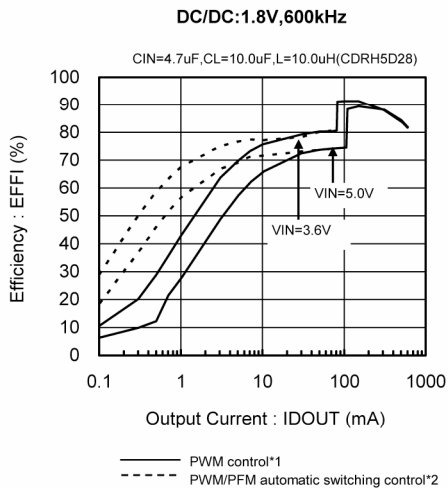
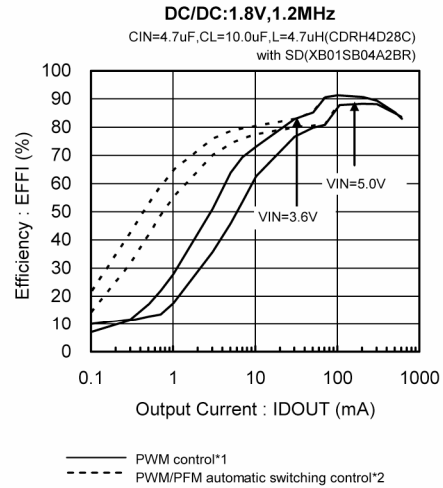
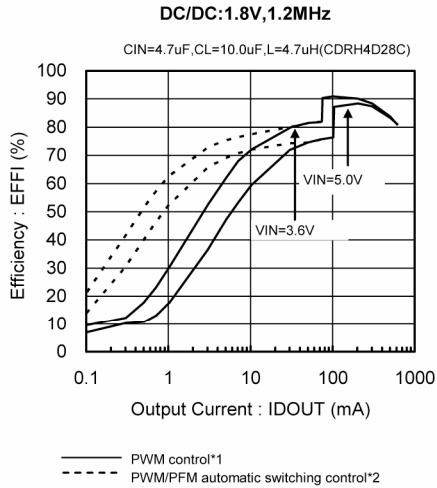

*1 XC9511A/B/C series , *2 XC9511D/E/F series

■ TYPICAL PERFORMANCE CHARACTERISTICS (Continued)

(A) DC/DC CONVERTER (Continued)

(2) Output Voltage vs. Output Current

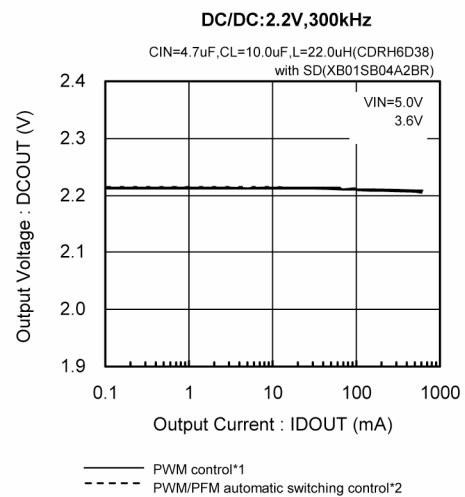
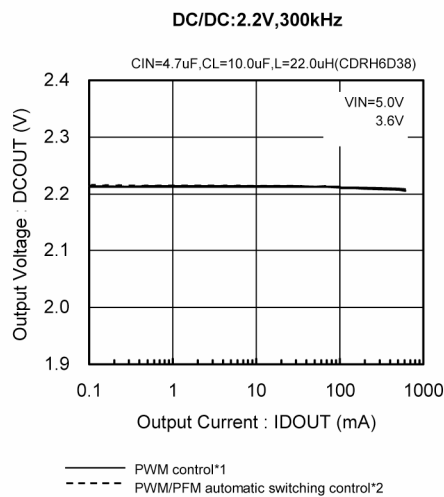
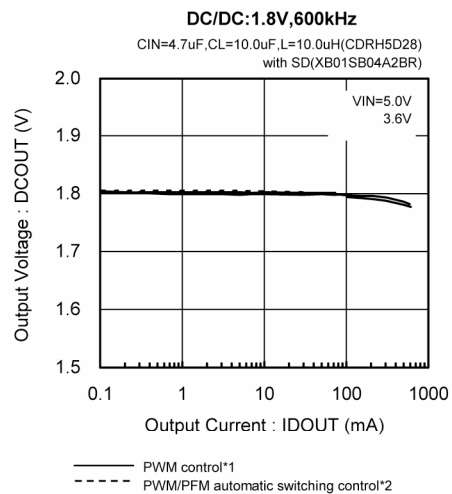
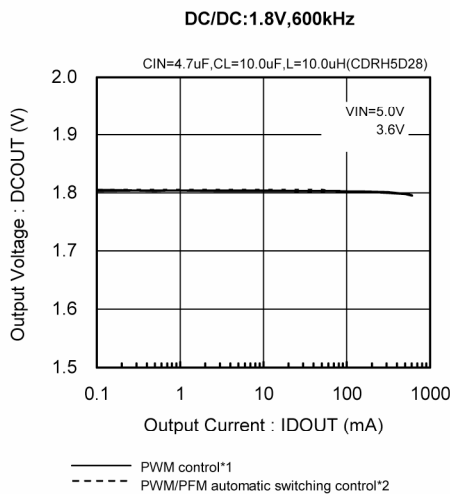
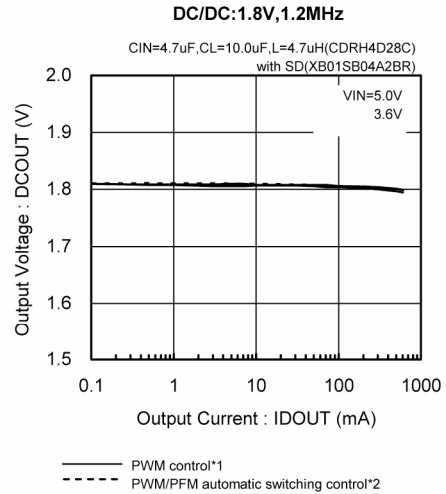
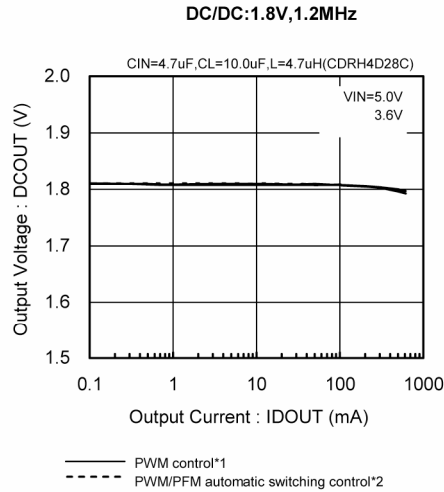

*1 XC9511A/B/C series , *2 XC9511D/E/F series

TYPICAL PERFORMANCE CHARACTERISTICS (Continued)

(A) DC/DC CONVERTER (Continued)

(3) Output Voltage vs. Ripple Voltage

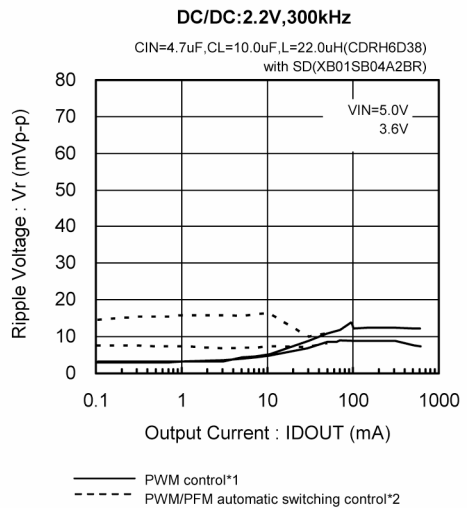
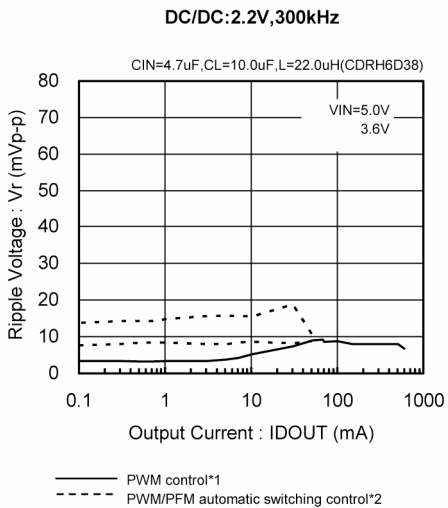
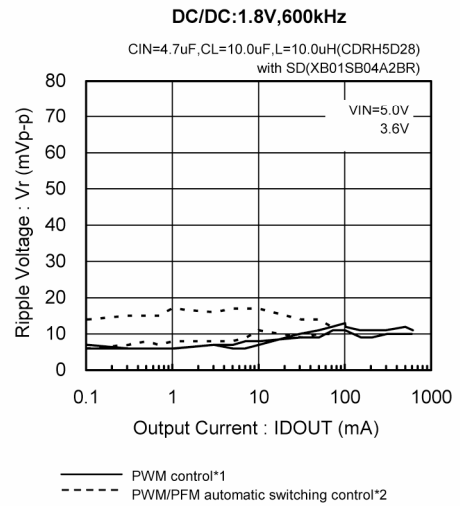
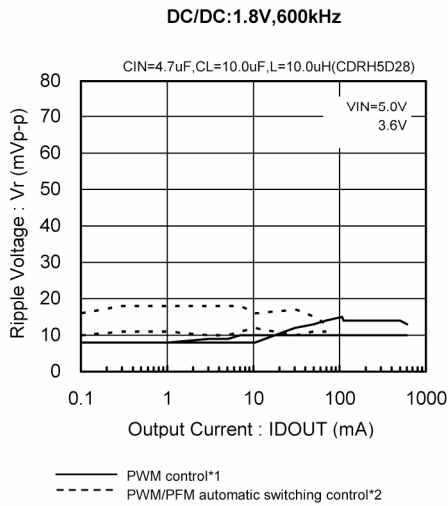
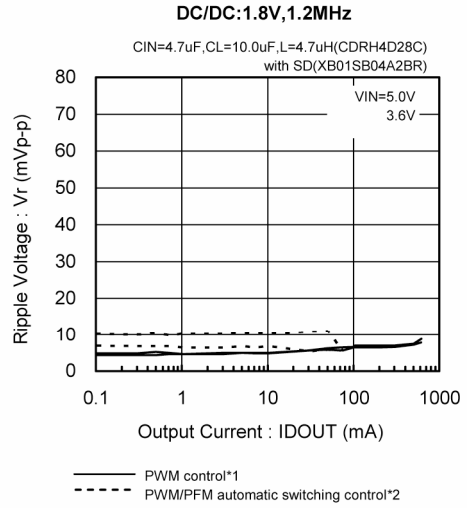
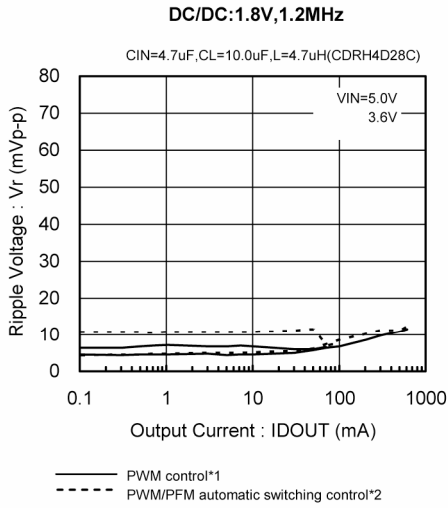

*1 XC9511A/B/C series , *2 XC9511D/E/F series

■ TYPICAL PERFORMANCE CHARACTERISTICS (Continued)

(A) DC/DC CONVERTER (Continued)

(4) Output Voltage vs. Ambient Temperature

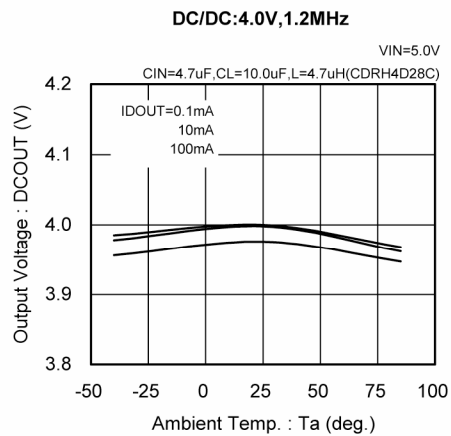
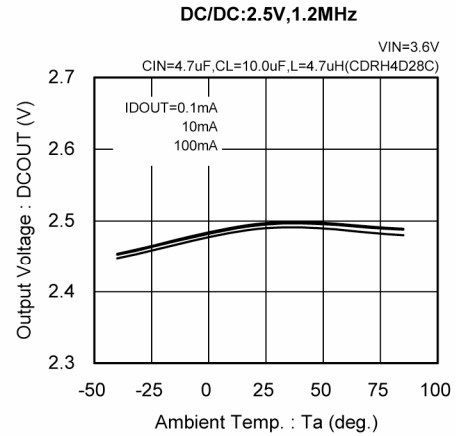
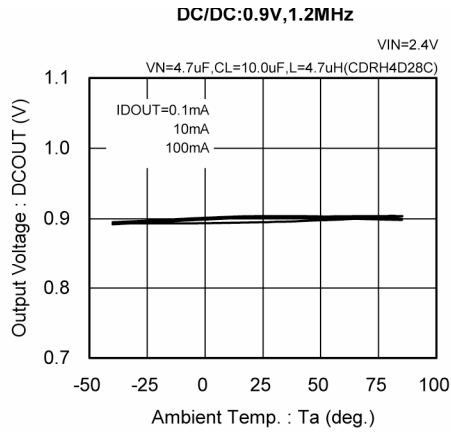

(5) Soft-Start Time vs. Ambient Temperature

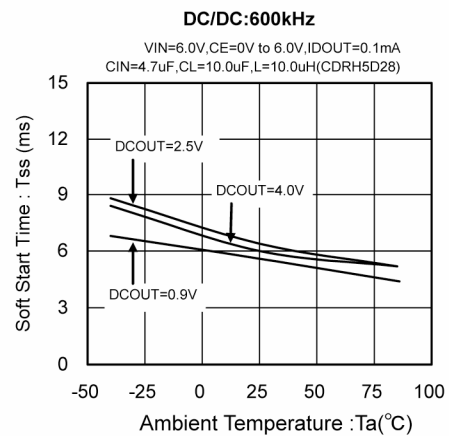
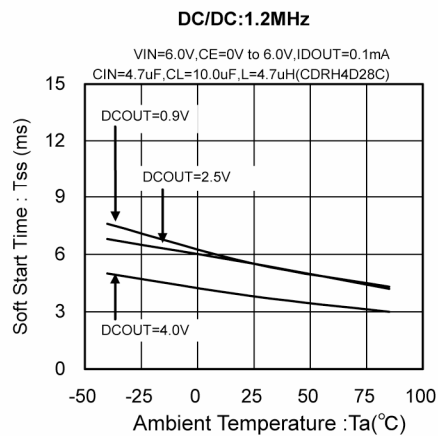

TYPICAL PERFORMANCE CHARACTERISTICS (Continued)

(A) DC/DC CONVERTER (Continued)

(6) LX Pch/Nch On Resistance vs. Input Voltage

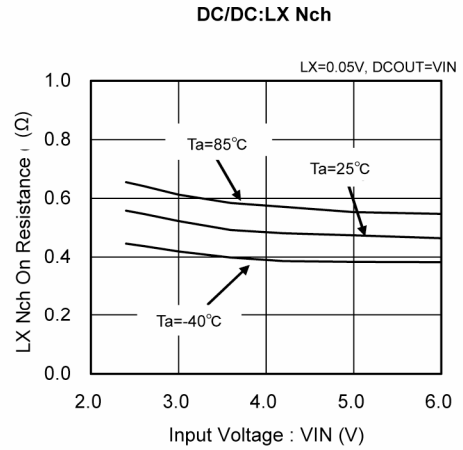
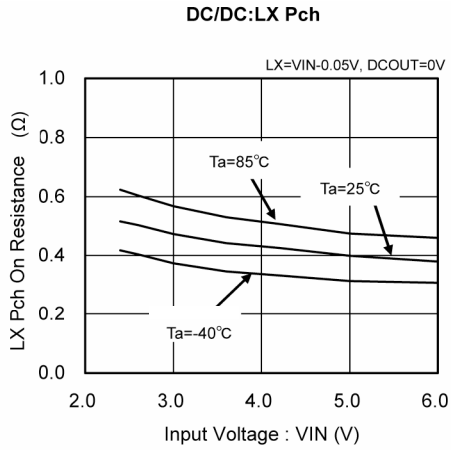

(7) Oscillation Frequency vs. Ambient Temperature

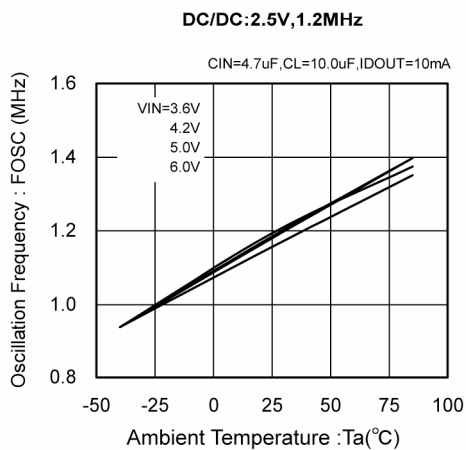

(8) U.V.L.O. Voltage vs. Ambient Temperature

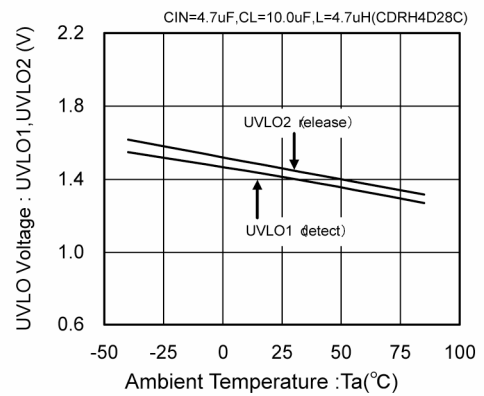

TYPICAL PERFORMANCE CHARACTERISTICS (Continued)

(A) DC/DC CONVERTER (Continued)

(9-1) DC/DC Load Transient Response (DcOUT: 1.5V, FOSC: 1.2MHz)

(a) PWM Control* (*XC9511A/B/C series)

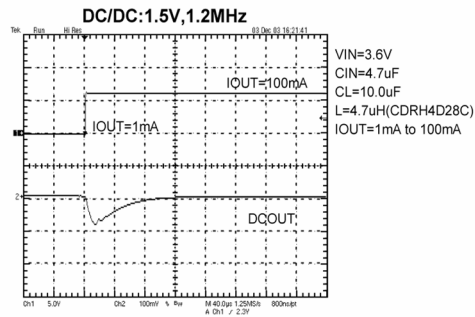

DCOUT: 100mV/div Time: 40usec/div

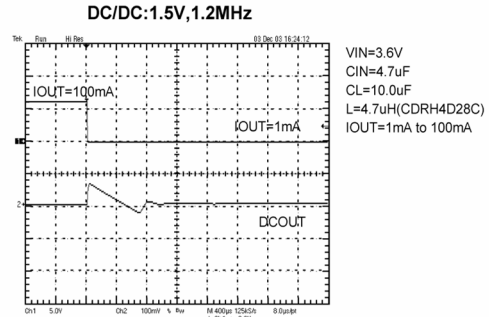

DCOUT: 100mV/div Time: 400usec/div

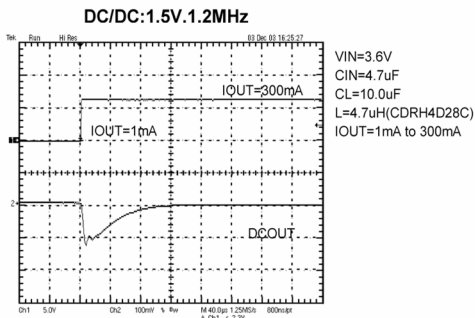

DCOUT: 100mV/div Time: 40usec/div

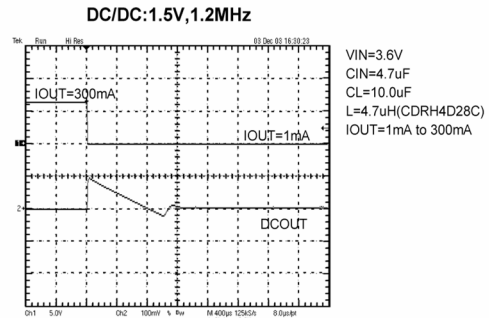

DCOUT: 100mV/div Time: 400usec/div

(b) PWM/PFM Automatic Switching Control* (*XC9511D/E/F series)

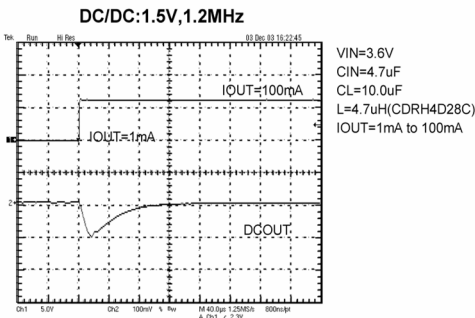

DCOUT: 100mV/div Time: 40usec/div

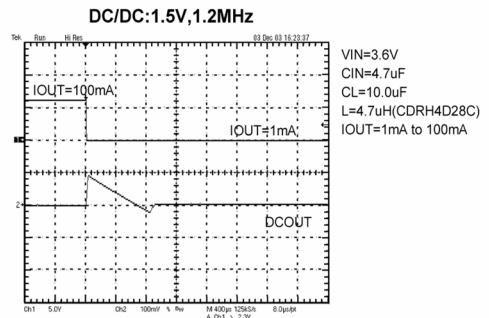

DCOUT: 100mV/div Time: 400usec/div

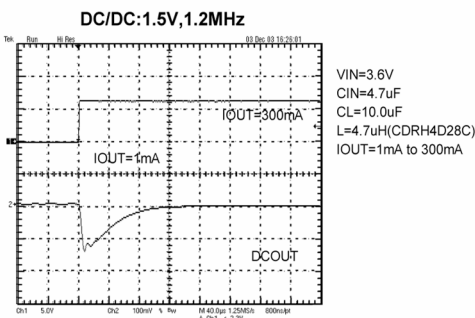

DCOUT: 100mV/div Time: 40usec/div

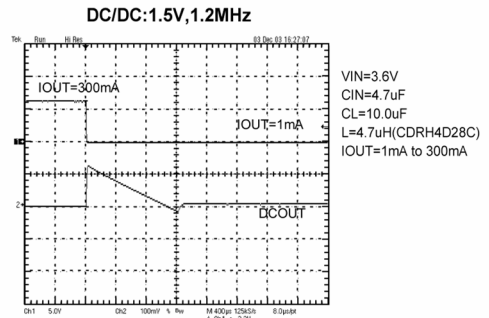

DCOUT: 100mV/div Time: 400usec/div

TYPICAL PERFORMANCE CHARACTERISTICS (Continued)

(A) DC/DC CONVERTER (Continued)

(9-2) DC/DC Load Transient Response (DcOUT: 1.8V, FOSC: 1.2MHz)

(a) PWM Control* (*XC9511A/B/C series)

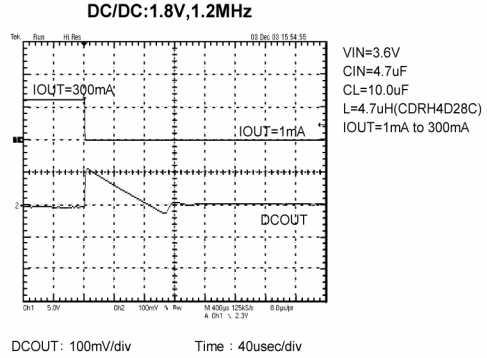
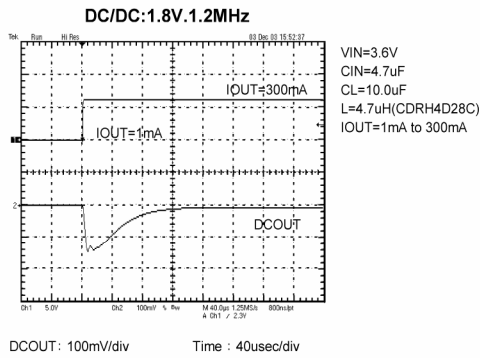
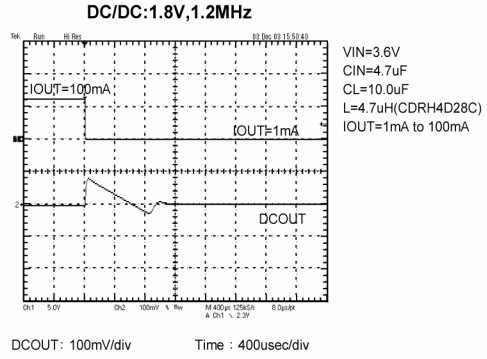
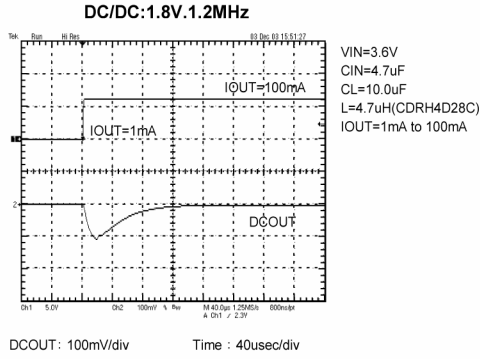

(b) PWM/PFM Automatic Switching Control* (*XC9511D/E/F series)

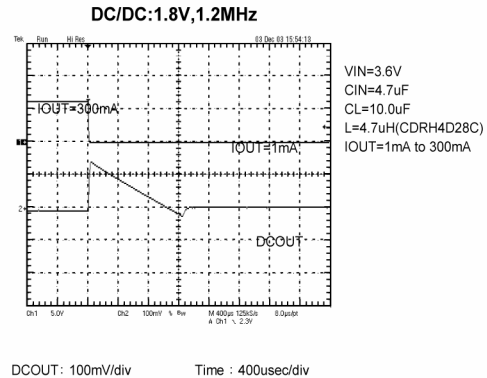
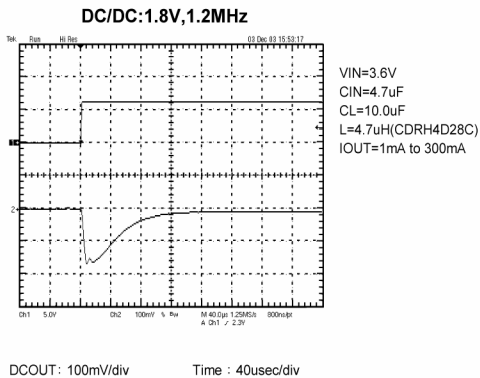
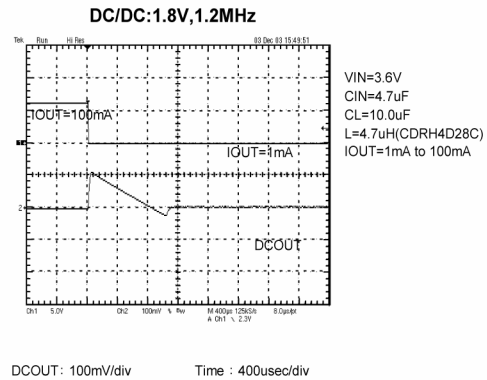
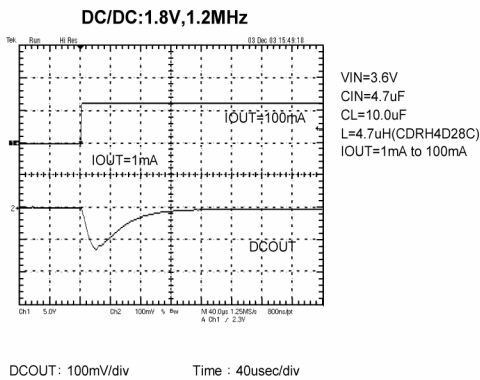

TYPICAL PERFORMANCE CHARACTERISTICS (Continued)

(A) DC/DC CONVERTER (Continued)

(9-3) DC/DC Load Transient Response (DCOUT: 3.3V, FOSC: 600kHz)

(a) PWM Control* (*XC9511A/B/C series)

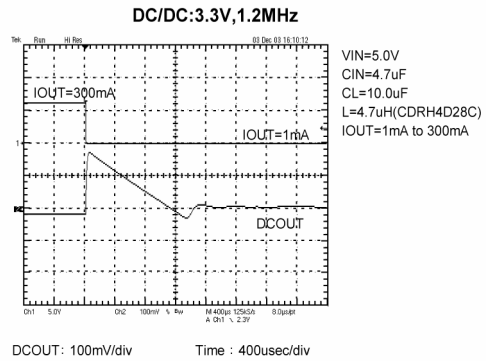
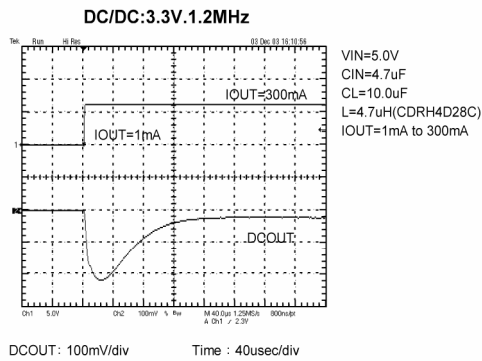
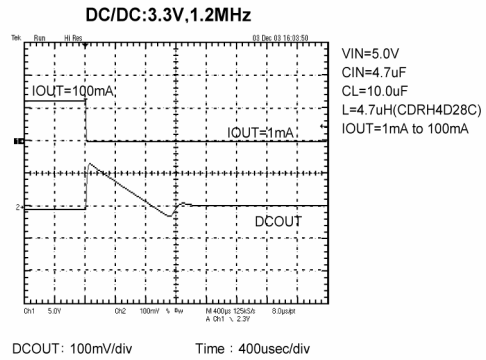
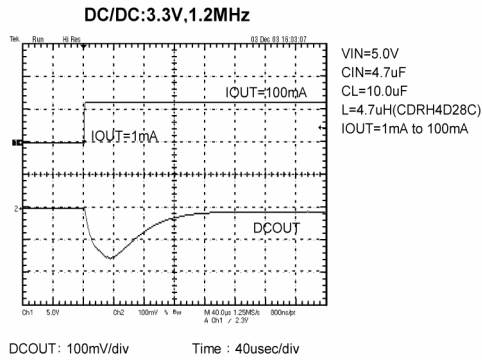

(b) PWM/PFM Automatic Switching Control* (*XC9511D/E/F series)

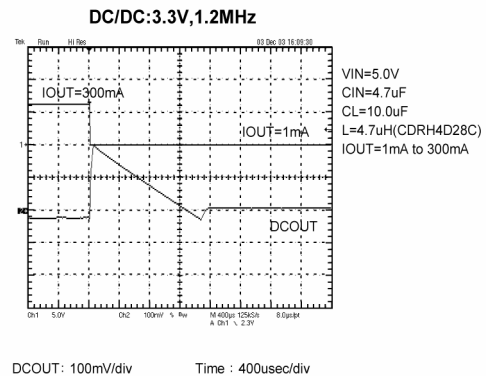
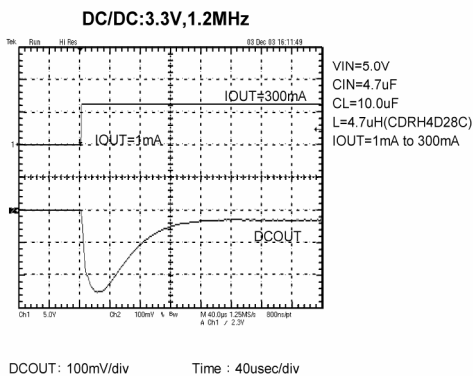
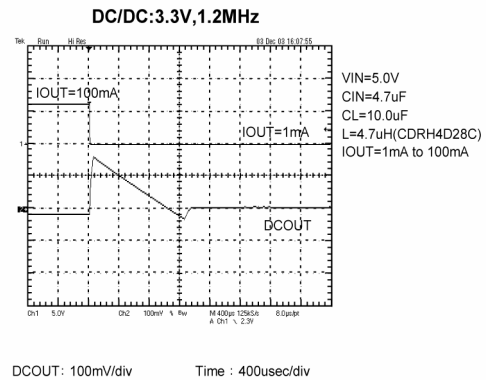
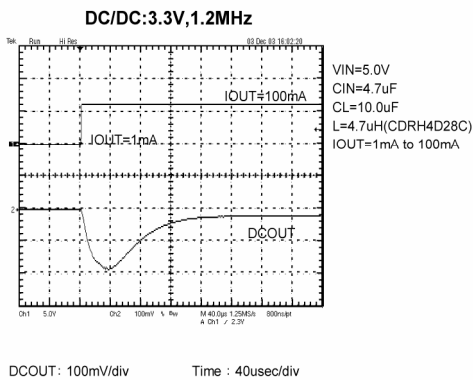

TYPICAL PERFORMANCE CHARACTERISTICS (Continued)

(A) DC/DC CONVERTER (Continued)

(9-4) DC/DC Load Transient Response (DcOUT: 1.5V, FOSC: 600kHz)

(a) PWM Control* (*XC9511A/B/C series)

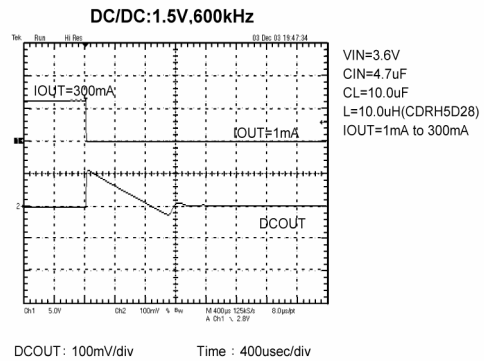
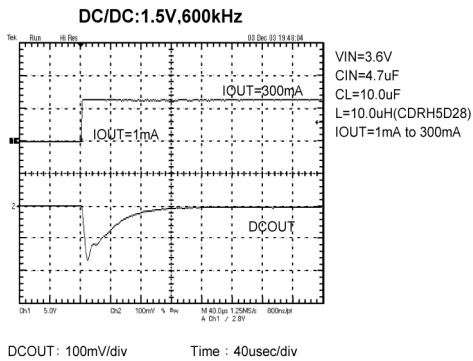
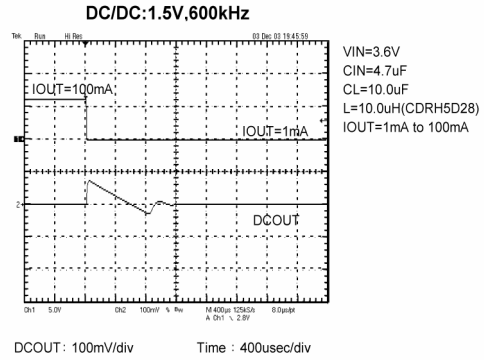
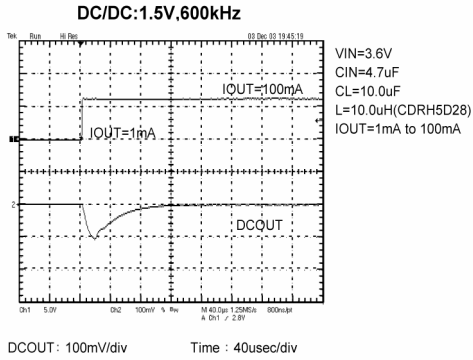

(b) PWM/PFM Automatic Switching Control* (*XC9511D/E/F series)

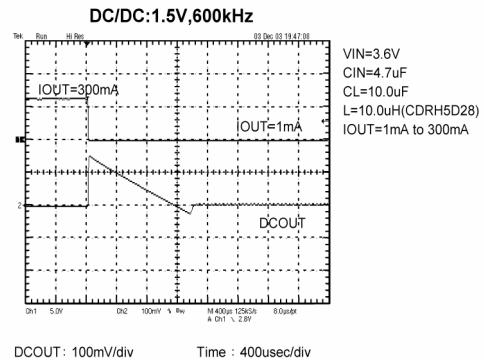
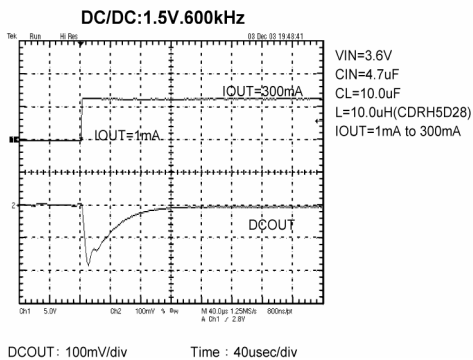
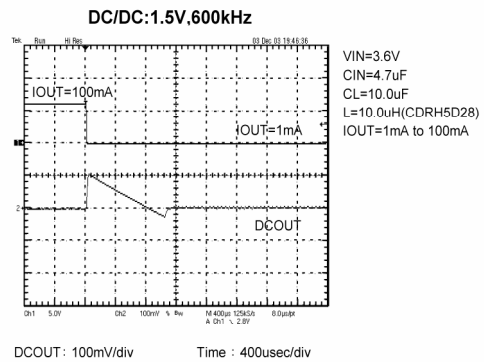
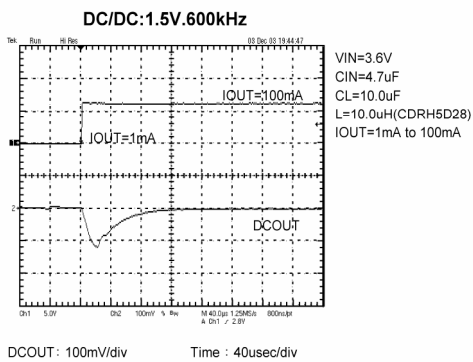

TYPICAL PERFORMANCE CHARACTERISTICS (Continued)

(A) DC/DC CONVERTER (Continued)

(9-5) DC/DC Load Transient Response (DcOUT: 1.8V, FOSC: 600kHz)

(a) PWM Control* (*XC9511A/B/C series)

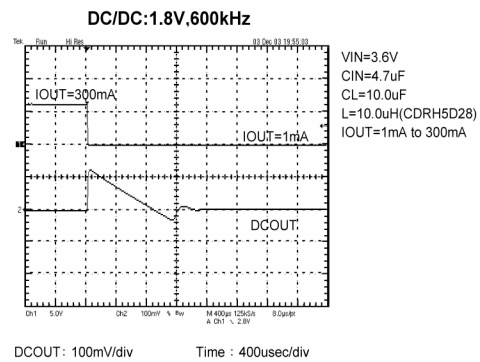
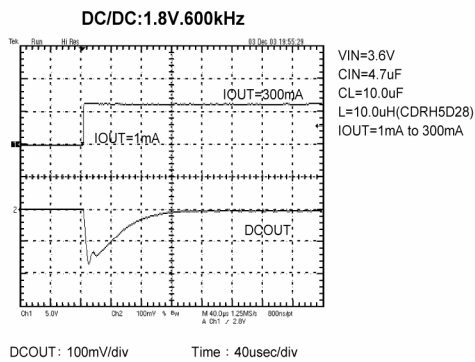
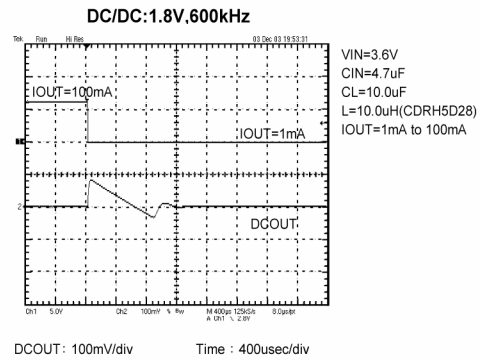
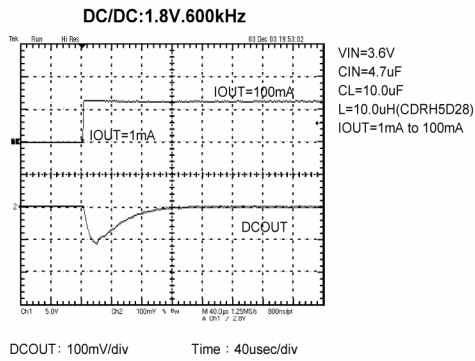

(b) PWM/PFM Automatic Switching Control* (*XC9511D/E/F series)

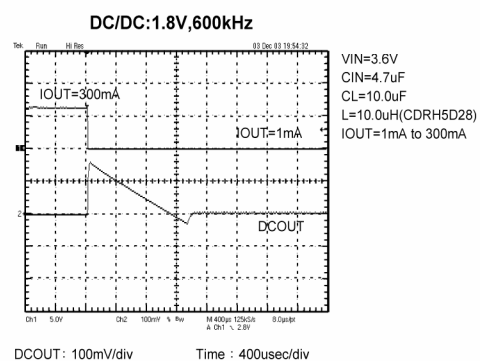
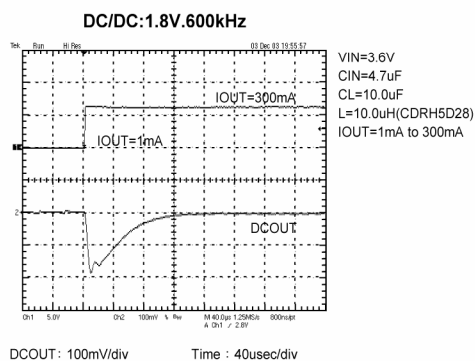
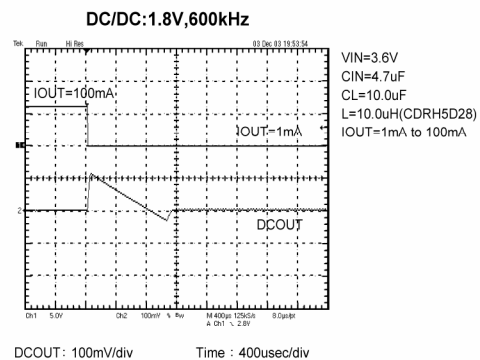
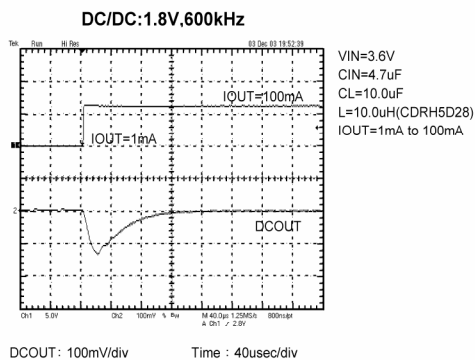

TYPICAL PERFORMANCE CHARACTERISTICS (Continued)

(A) DC/DC CONVERTER (Continued)

(9-6) DC/DC Load Transient Response (DCOUT: 3.3V, FOSC: 600kHz)

(a) PWM Control* (*XC9511A/B/C series)

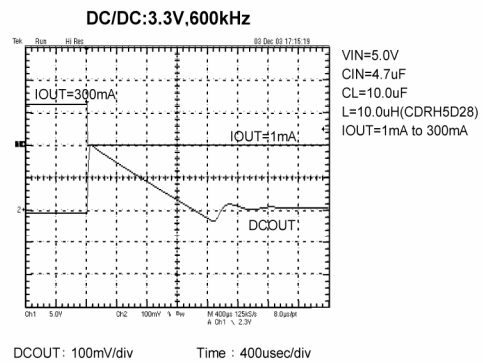
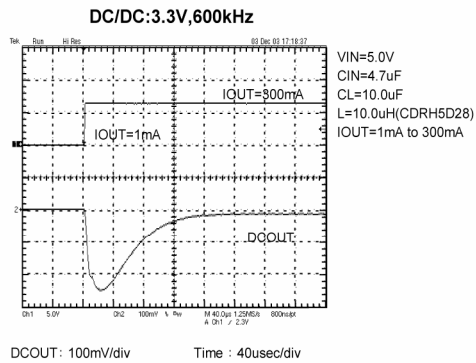
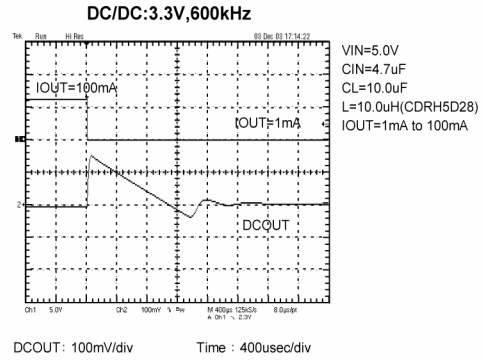
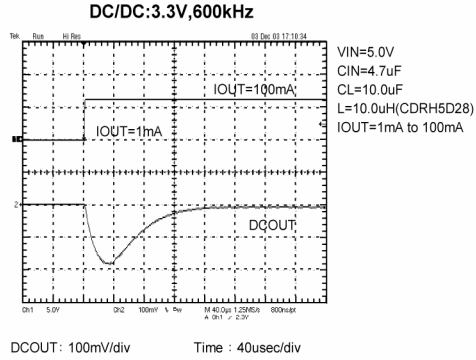

(b) PWM/PFM Automatic Switching Control* (*XC9511D/E/F series)

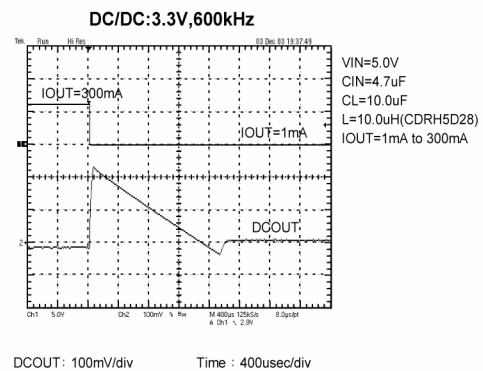
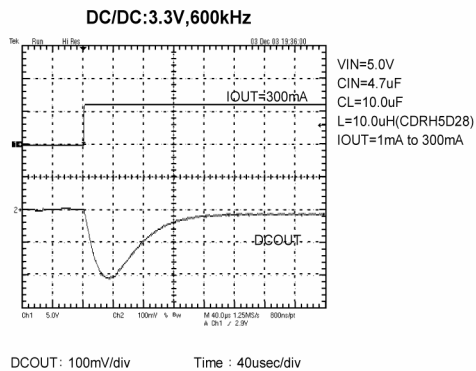
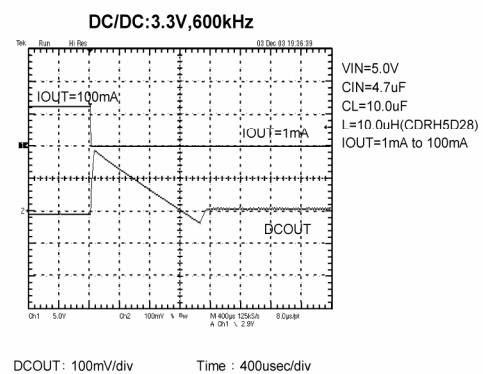
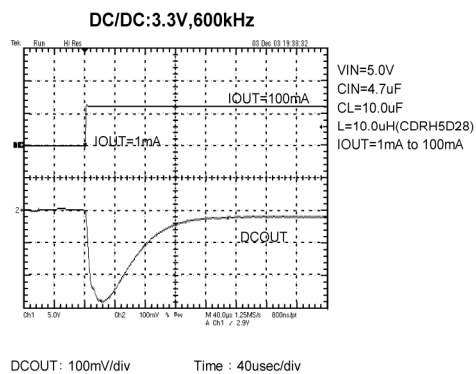

■ TYPICAL PERFORMANCE CHARACTERISTICS (Continued)

(B) VOLTAGE REGULATOR

(1) Output Voltage vs. Input Voltage

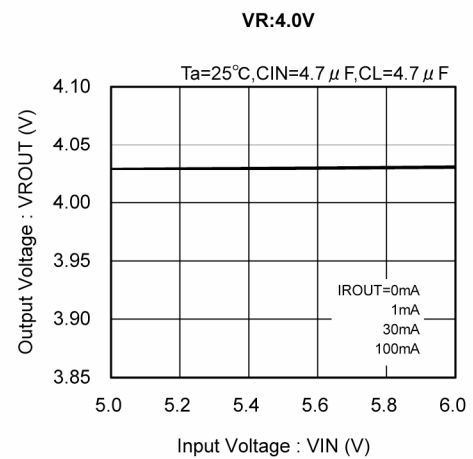
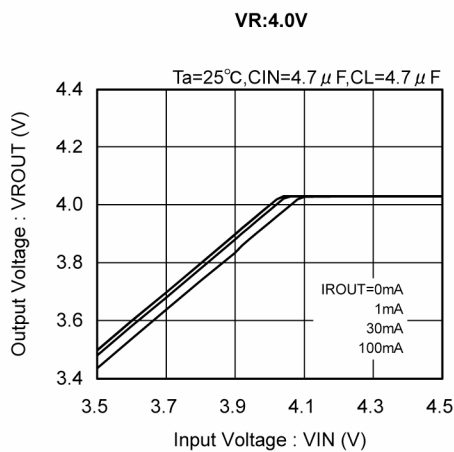
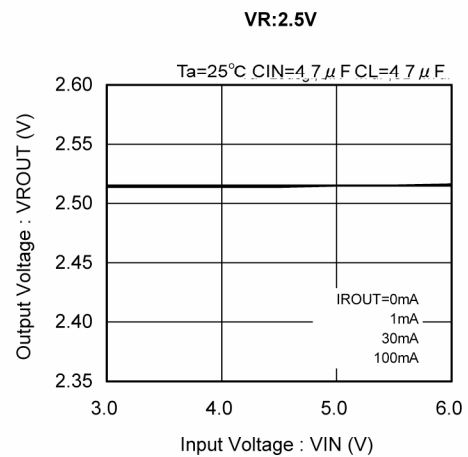
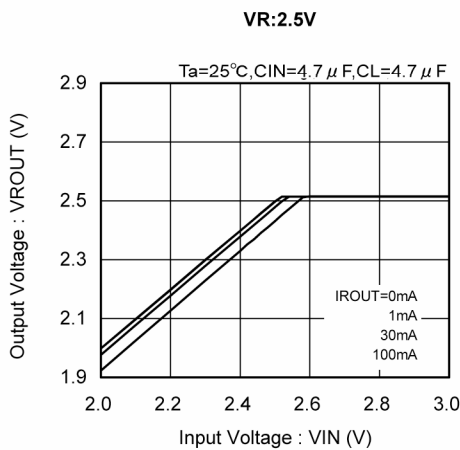
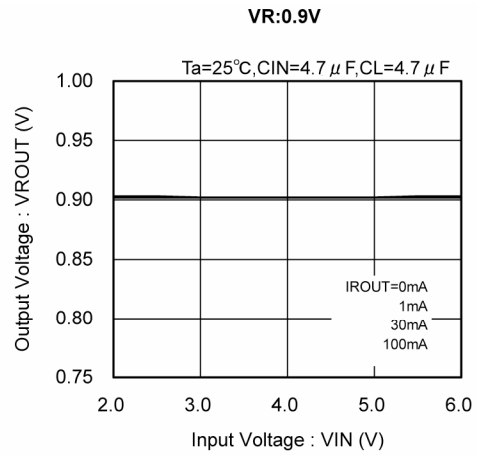
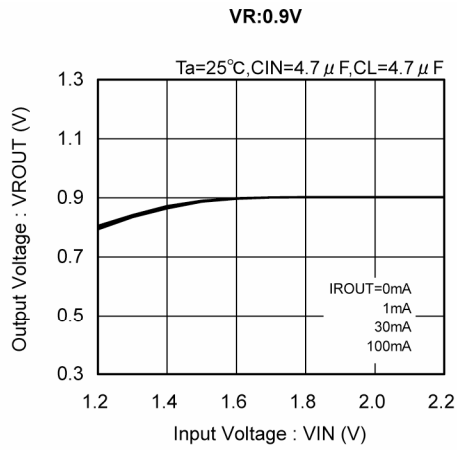

TYPICAL PERFORMANCE CHARACTERISTICS (Continued)

(B) VOLTAGE REGULATOR (Continued)

(2) Output Voltage vs. Output Current (Current Limit)

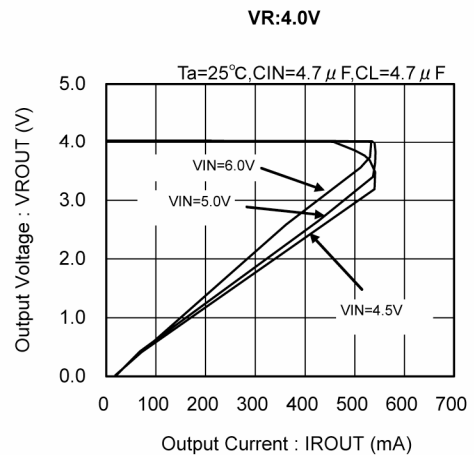
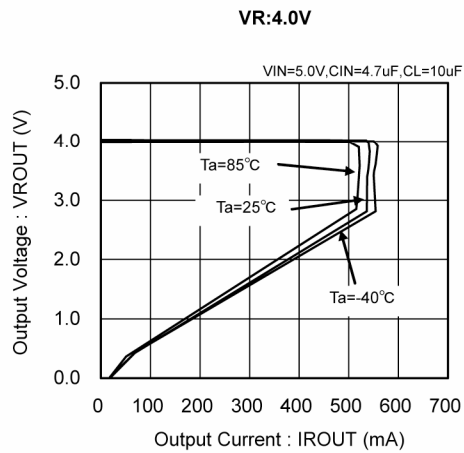
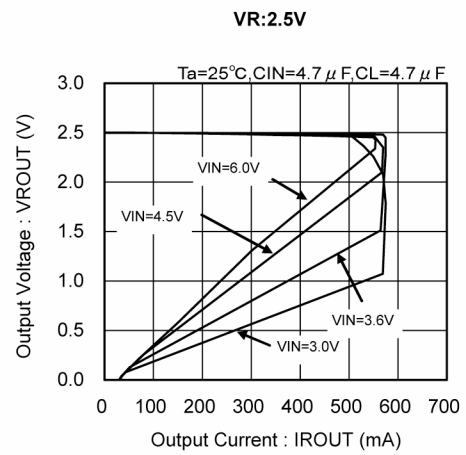
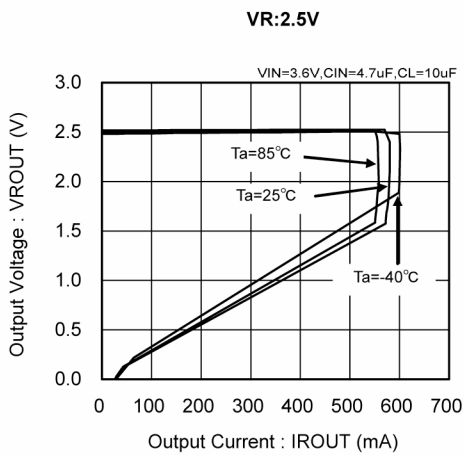
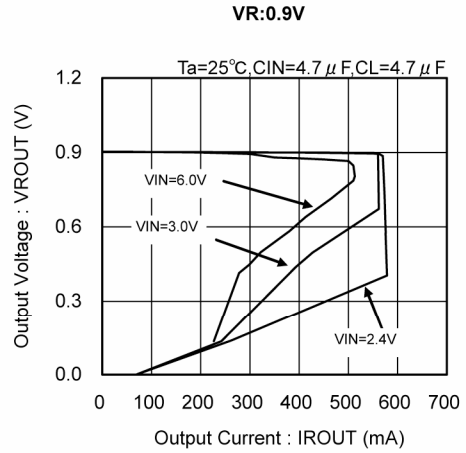
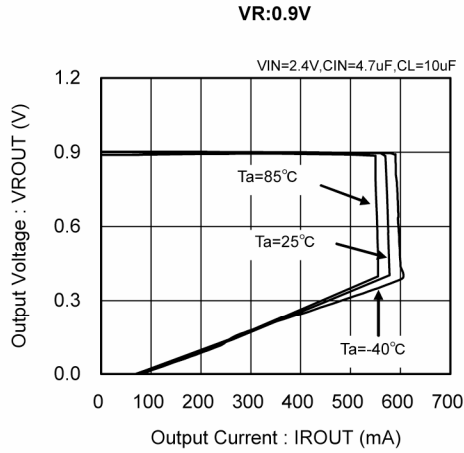

TYPICAL PERFORMANCE CHARACTERISTICS (Continued)
(B) VOLTAGE REGULATOR (Continued)

(3) Dropout Voltage vs. Output Current

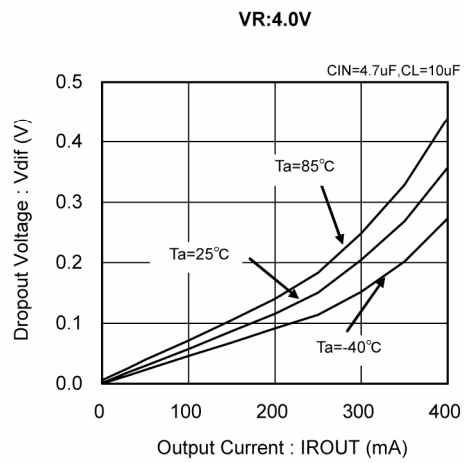
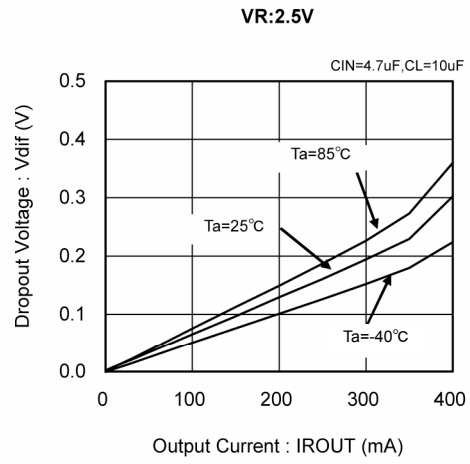
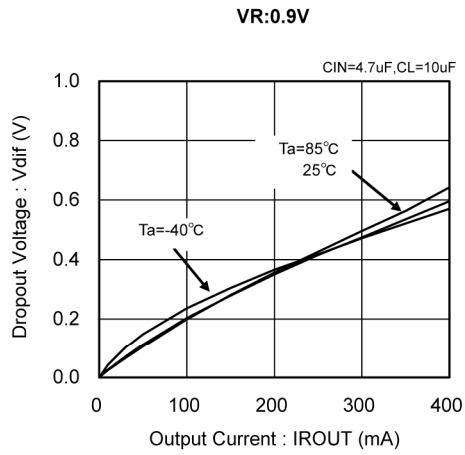

TYPICAL PERFORMANCE CHARACTERISTICS (Continued)

(B) VOLTAGE REGULATOR (Continued)

(4) Output Voltage vs. Output Current

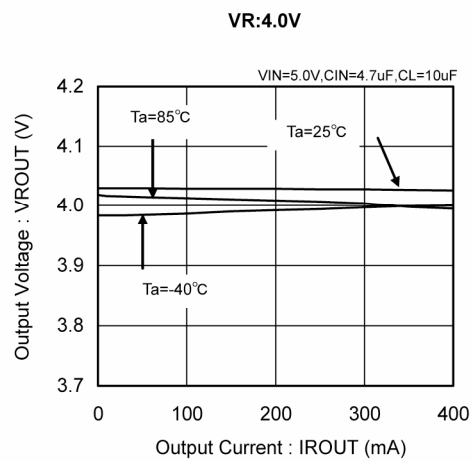
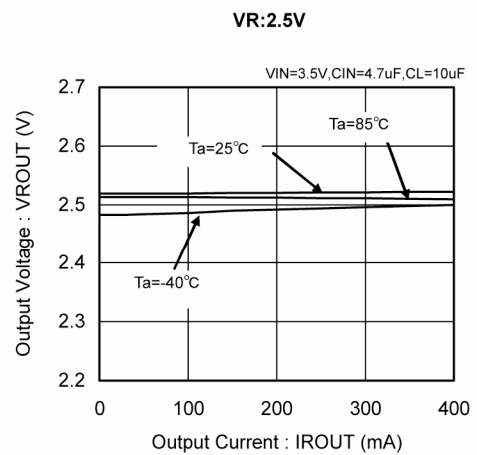
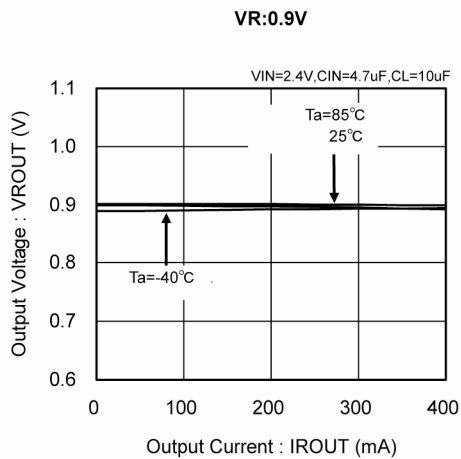

■ TYPICAL PERFORMANCE CHARACTERISTICS (Continued)

(B) VOLTAGE REGULATOR (Continued)

(5) Ripple Rejection Ratio vs. Ripple Frequency

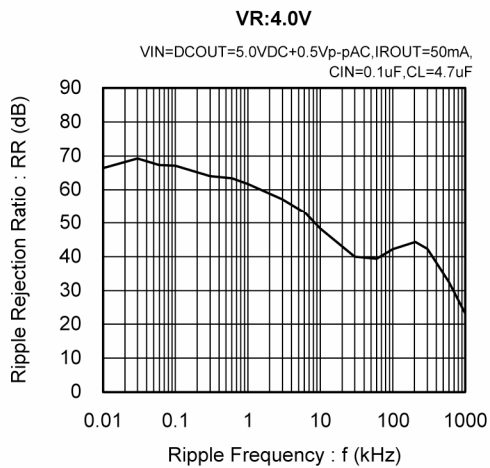
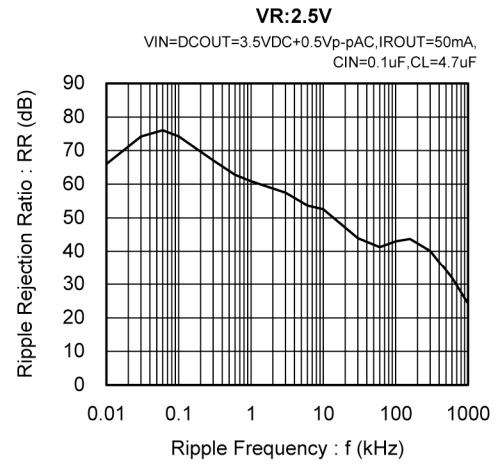
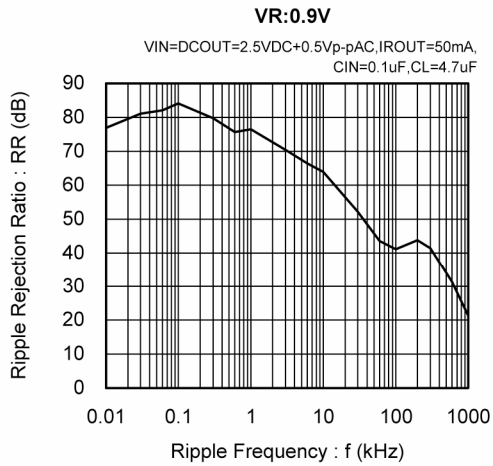

TYPICAL PERFORMANCE CHARACTERISTICS (Continued)

(B) VOLTAGE REGULATOR (Continued)

(6) VR Load Transient Response

VR:0.9V

IROUT=10mA to 50mA

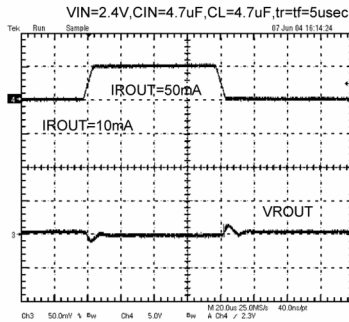

VR:2.5V

IROUT=10mA to 50mA

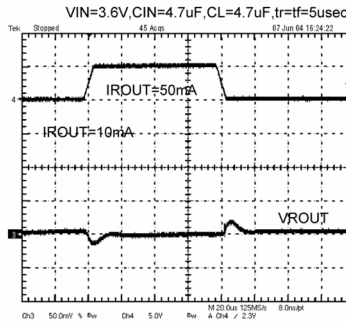

VR:4.0V

IROUT=10mA to 50mA

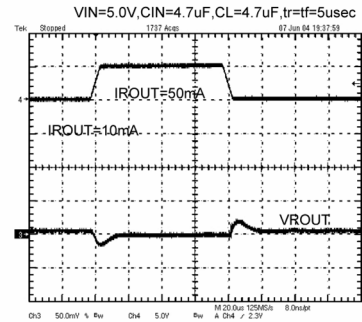

VR:0.9V

IROUT=50mA to 100mA

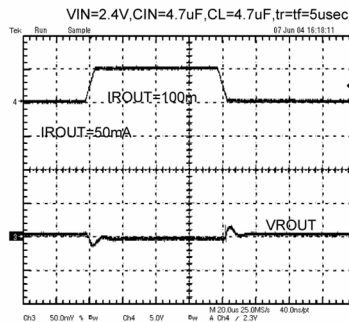

VR:2.5V

IROUT=50mA to 100mA

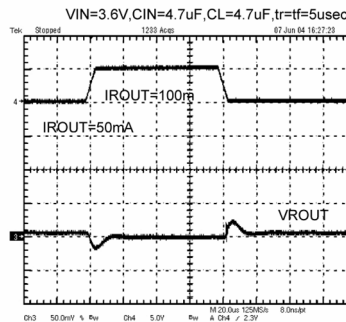

VR:4.0V

IROUT=50mA to 100mA

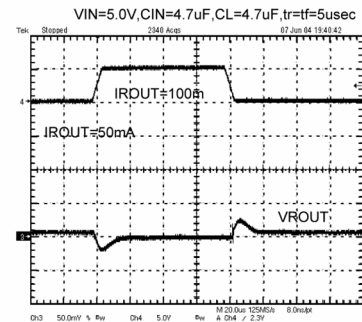

VR:0.9V

IROUT=10mA to 100mA

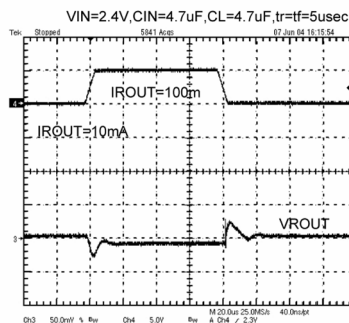

VR:2.5V

IROUT=10mA to 100mA

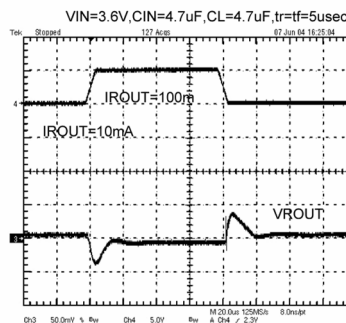

VR:4.0V

IROUT=10mA to 100mA

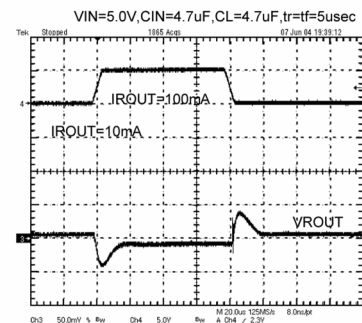

■ TYPICAL PERFORMANCE CHARACTERISTICS (Continued)

(C) VOLTAGE DETECTOR

(1) Output Current vs. Input Voltage

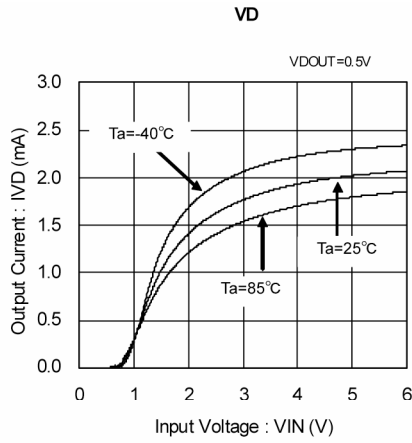

(2) Detect Voltage vs. Input Voltage

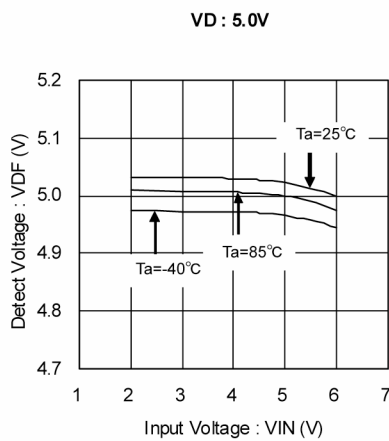
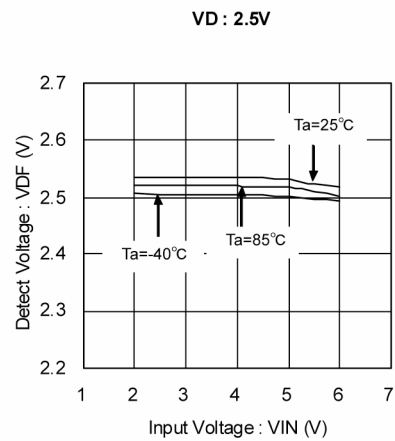
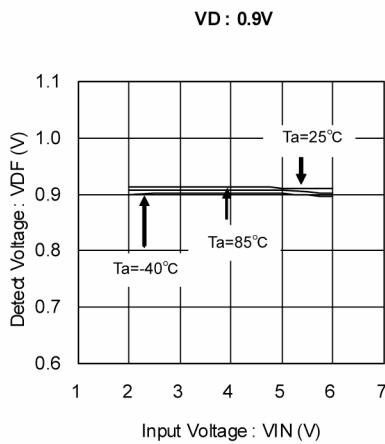

TYPICAL PERFORMANCE CHARACTERISTICS (Continued)

(C) VOLTAGE DETECTOR (Continued)

(3) Detect Voltage, Release Voltage vs. Ambient Temperature

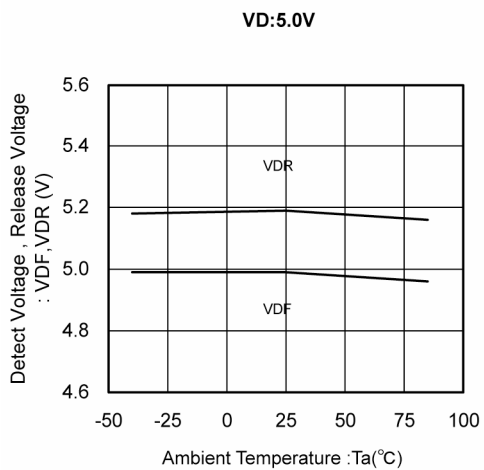
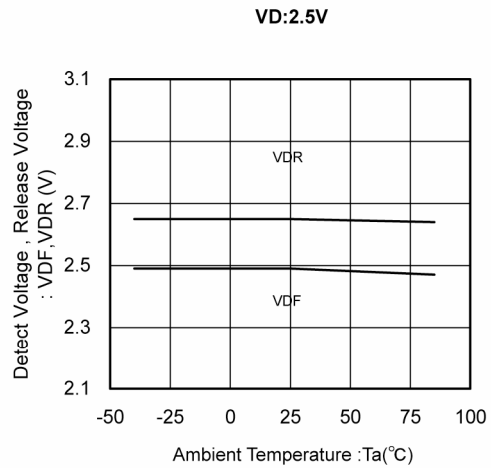
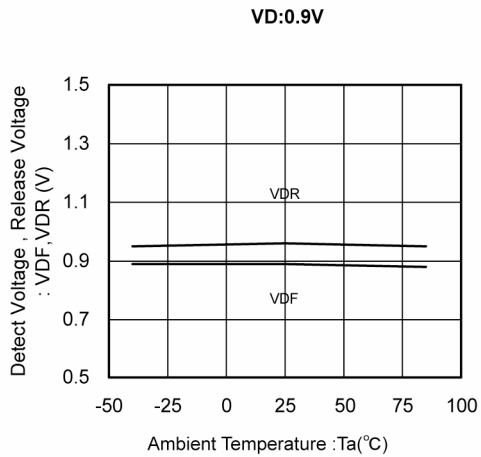

■ TYPICAL PERFORMANCE CHARACTERISTICS (Continued)

(D) COMMON

(1) Supply Current vs. Ambient Temperature (DC/DC & VR & VD)

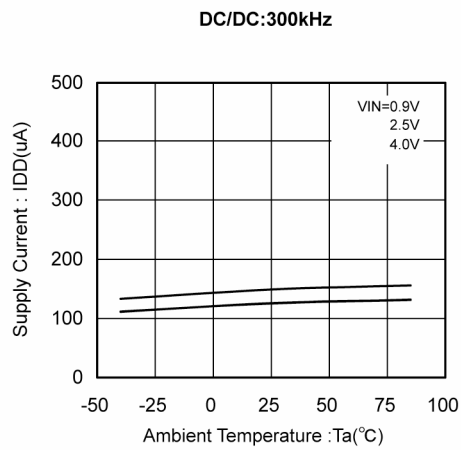
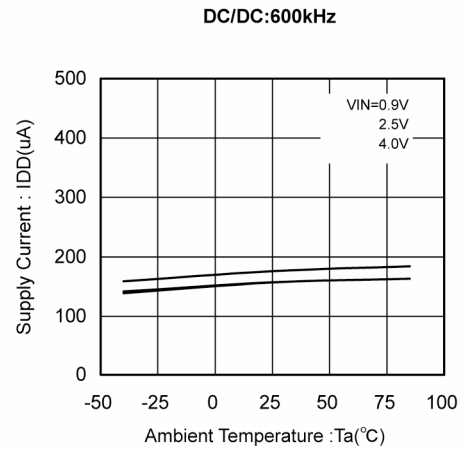
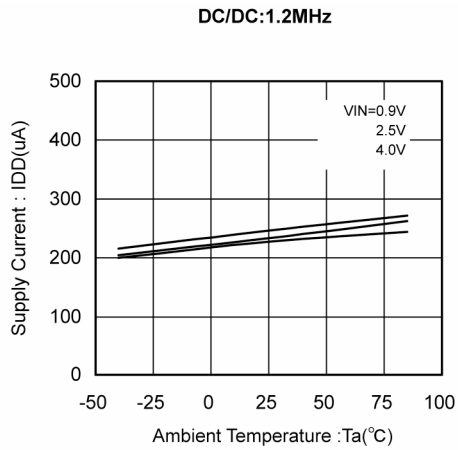

PACKAGING INFORMATION

●SOP-8

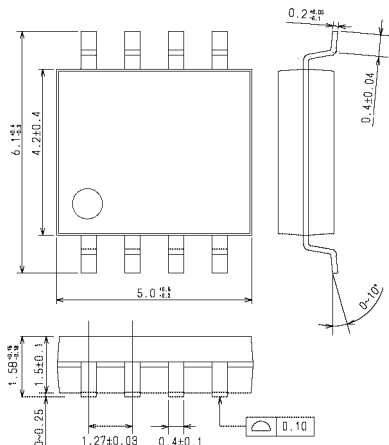

MARKING RULE

●SOP-8

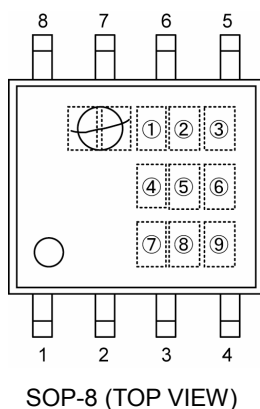

SOP-8 (TOP VIEW)

①②Represents product series

MARK		PRODUCT SERIES
①	②	
1	1	XC9511xxxxSx

③Represents DC/DC control methods, MODE pin and VD sense pin

MARK	DC/DC CONTROL	VD SENSE	PRODUCT SERIES
A	PWM Control	VDD	XC9511AxxxSx
B		DcOUT	XC9511BxxxSx
C		VROUT	XC9511CxxxSx
D	PWM, PFM/PWM Manual Switch	VDD	XC9511DxxxSx
E		DcOUT	XC9511ExxxSx
F		VROUT	XC9511FxxxSx

④⑤Represents detect voltage DC/DC, VR and VD (ex.)

MARK		DC/DC	VR	VD	PRODUCT SERIES
④	⑤				
1	4	1.8V	3.3V	4.0V	XC9511*14*S*

⑥Represents oscillation frequency

MARK	OSCILLATION FREQUENCY	PRODUCT SERIES
3	300kHz	XC9511xxx3Ax
6	600kHz	XC9511xxx6Ax
C	1.2MHz	XC9511xxxCAx

⑦Represents single digit of production year (ex.)

MARK	PRODUCTION YEAR
3	2003
4	2004

⑧⑨Represents the production lot number

0 to 9, A to Z reverse character 0 to 9, A to Z repeated

(G, I, J, O, Q, W excepted)

Note: No character inversion used.

1. The products and product specifications contained herein are subject to change without notice to improve performance characteristics. Consult us, or our representatives before use, to confirm that the information in this catalog is up to date.
2. We assume no responsibility for any infringement of patents, patent rights, or other rights arising from the use of any information and circuitry in this catalog.
3. Please ensure suitable shipping controls (including fail-safe designs and aging protection) are in force for equipment employing products listed in this catalog.
4. The products in this catalog are not developed, designed, or approved for use with such equipment whose failure of malfunction can be reasonably expected to directly endanger the life of, or cause significant injury to, the user.
(e.g. Atomic energy; aerospace; transport; combustion and associated safety equipment thereof.)
5. Please use the products listed in this catalog within the specified ranges.
Should you wish to use the products under conditions exceeding the specifications, please consult us or our representatives.
6. We assume no responsibility for damage or loss due to abnormal use.
7. All rights reserved. No part of this catalog may be copied or reproduced without the prior permission of Torex Semiconductor Ltd.

TOREX SEMICONDUCTOR LTD.