

**PLEASE CHECK WWW.MOLEX.COM FOR LATEST PART INFORMATION**

**Part Number:** [0430200400](#)  
**Status:** **Active**  
**Overview:** Micro-Fit, 3.0™  
**Description:** 3.00mm (.118") Pitch Micro-Fit 3.0™ Plug Housing, Dual Row, with Panel Mount Ears, 4 Circuits

**Documents:**

[3D Model](#) [Product Specification PS-43045 \(PDF\)](#)  
[Drawing \(PDF\)](#) [RoHS Certificate of Compliance \(PDF\)](#)

**Agency Certification**

CSA	LR19980
TUV	R72081037
UL	E29179

**General**

Product Family	Crimp Housings
Series	<a href="#">43020</a>
Comments	Glow Wire Equivalent Part Number <a href="#">430200408</a>
Overview	<u>Micro-Fit, 3.0™</u>
Product Literature Order No	USA-106
Product Name	Micro-Fit 3.0™

**Physical**

Circuits (maximum)	4
Circuits Detail	4
Color - Resin	Black
Flammability	94V-0
Gender	Male
Glow-Wire Compliant	No
Lock to Mating Part	Yes
Material - Resin	Polyester
Number of Rows	2
Packaging Type	Bag
Panel Mount	Yes
Pitch - Mating Interface (in)	0.118 In
Pitch - Mating Interface (mm)	3.00 mm
Pitch - Term. Interface (in)	0.118 In
Pitch - Term. Interface (mm)	3.00 mm
Polarized to Mating Part	Yes
Stackable	No
Temperature Range - Operating	-40°C to +105°C

**Electrical**

Current - Maximum per Contact	5A
-------------------------------	----

**Material Info**

**Reference - Drawing Numbers**

Product Specification	PS-43045, RPS-43045-001, RPS-43045-003, RPS-43045-004
Sales Drawing	SDA-43020-****

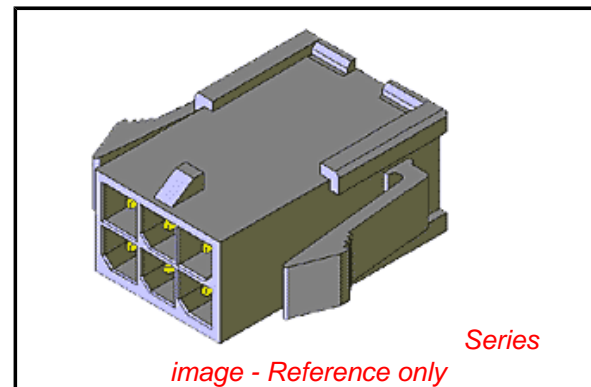

**EU RoHS**

**ELV and RoHS Compliant**

**REACH SVHC**

Not Reviewed

**Halogen-Free**

**Status**

**Not Halogen-Free**

**Need more information on product environmental compliance?**

Email [productcompliance@molex.com](mailto:productcompliance@molex.com)  
 For a multiple part number RoHS Certificate of Compliance, [click here](#)

Please visit the [Contact Us](#) section for any non-product compliance questions.

**China RoHS**



**Search Parts in this Series**

[43020Series](#)

**Mates With**

[43025 Micro-Fit 3.0™ Receptacle Housing](#)

**Use With**

[Micro-Fit 3.0™ Crimp Terminal, Male](#)

ASSEMBLY ITEM NUMBER	PART CHARACTERISTICS	
	NUMBER OF POSITION	PANEL MOUNT OPTION
43020-0200	02	YES
43020-0201	02	NO
43020-0400	04	YES
43020-0401	04	NO
43020-0600	06	YES
43020-0601	06	NO
43020-0800	08	YES
43020-0801	08	NO
43020-1000	10	YES
43020-1001	10	NO
43020-1200	12	YES
43020-1201	12	NO
43020-1400	14	YES
43020-1401	14	NO
43020-1600	16	YES
43020-1601	16	NO
43020-1800	18	YES
43020-1801	18	NO
43020-2000	20	YES
43020-2001	20	NO
43020-2200	22	YES
43020-2201	22	NO
43020-2400	24	YES
43020-2401	24	NO

CKT. NO.	DIM. 'A'	DIM. 'B'	DIM. 'C'	DIM. 'D'
2	.152/(3.86)	N/A	.166/(4.21)	.311/(7.90)
4	.270/(6.85)	.118/(3.00)	.284/(7.21)	.429/(10.90)
6	.388/(9.85)	.236/(6.00)	.402/(10.21)	.547/(13.89)
8	.506/(12.85)	.354/(9.00)	.520/(13.21)	.665/(16.89)
10	.624/(15.85)	.472/(12.00)	.638/(16.21)	.783/(19.89)
12	.742/(18.85)	.591/(15.00)	.756/(19.21)	.901/(22.89)
14	.860/(21.85)	.709/(18.00)	.874/(22.20)	1.019/(25.88)
16	.978/(24.85)	.827/(21.00)	.992/(25.20)	1.137/(28.88)
18	1.096/(27.85)	.945/(24.00)	1.110/(28.20)	1.255/(31.88)
20	1.215/(30.85)	1.063/(27.00)	1.229/(31.22)	1.373/(34.87)
22	1.333/(33.85)	1.181/(30.00)	1.347/(34.22)	1.491/(37.87)
24	1.451/(36.85)	1.299/(33.00)	1.465/(37.22)	1.609/(40.87)

- NOTES:
- HOUSING MATERIAL: UNFILLED POLYESTER (PBT), UL 94V-0  
COLOR - BLACK
  - FINISH: N/A
  - PRODUCT SPECIFICATION: PS-43045
  - PACKAGING SPECIFICATION: N/A
  - THIS HOUSING MATES WITH MICRO-FIT RECEPTACLE #43025-\*\*\*\*
  - THIS HOUSING TO BE USED WITH MOLEX MALE TERMINAL #43031-\*\*\*\*
  - DESIGNED FOR .055(1.4) MINIMUM TO A .100(2.54) MAXIMUM THICK PANEL OR PRINTED CIRCUIT BOARD.
  - SEE SECTION 'D'-'D' FOR TERMINAL ORIENTATION IN HOUSING.
  - PANEL MOUNT FEATURES MUST LOCK ON SIDE OPPOSITE PUNCH SIDE FOR OPTIMUM RETENTION.
  - PART CONFORMS TO CLASS 'B' REQUIREMENTS OF COSMETIC SPECIFICATION PS-45499-002. SOME HOUSINGS MAY HAVE A SMALL GATE BLEMISH NEAR THE GATE LOCATION THAT DOES NOT AFFECT FUNCTIONALITY.

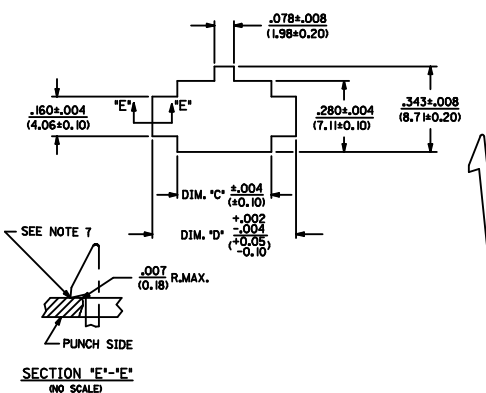
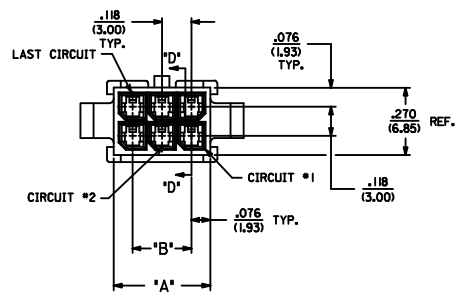

RECOMMENDED PANEL CUT-OUT

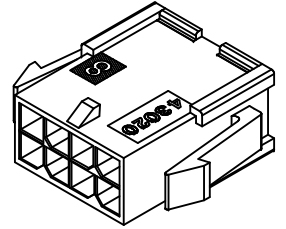
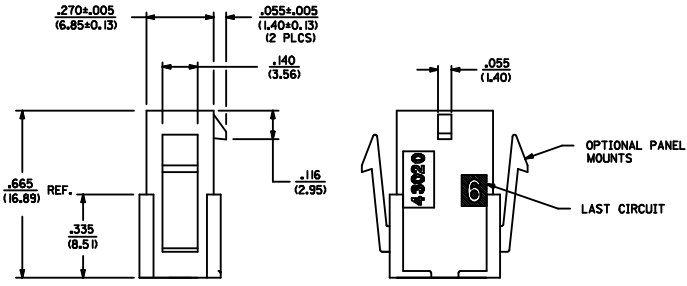

PLUG WITH OPTIONAL PANEL MOUNTS  
ISO VIEW  
(8 CIRCUIT SHOWN)

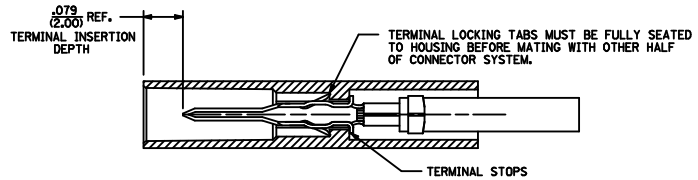

SECTION 'B'-'B'

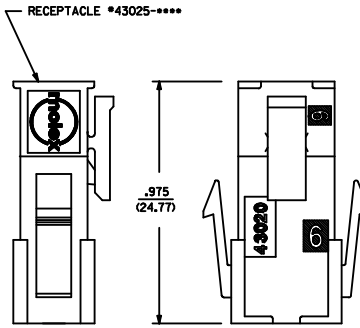

MATED MICRO-FIT CONNECTOR

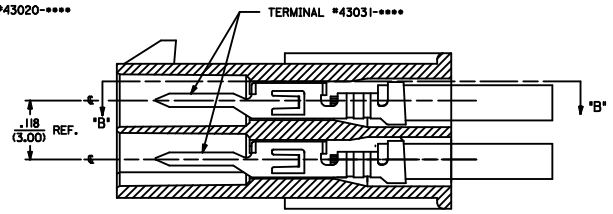

SECTION 'D'-'D'  
WITH TERMINAL  
SCALE 8X

COSMETIC SPEC ELEC. NO. UCP2009-2841 DRWN:SSOUSEK 2009/05/26 CHKD:KMPFER 2009/05/28 APPR:FSMTH 2009/05/28 REV DESCRIPTION	QUALITY SYMBOLS ▽=0 ▽=0		GENERAL TOLERANCES (UNLESS SPECIFIED) mm INCH 4 PLACES ±.010 ±.010 3 PLACES ±.025 ±.014 2 PLACES ±.035 ±.014 1 PLACE ±.035 ±.014 ANGULAR ±1/2°		DIMENSION STYLE IN/MM DRAWN BY DATE AFG 1993/01/07 CHECKED BY DATE BAP 1993/01/07 APPROVED BY DATE RAS 1993/01/07		SCALE 4:1 DESIGN UNITS METRIC THIRD ANGLE PROJECTION	
	DRAFT WHERE APPLICABLE MUST REMAIN WITHIN DIMENSIONS		MATERIAL NO. SEE CHART DOCUMENT NO. SDA-43020-****		TITLE MICRO-FIT(3.0) 2 THRU 24 CIRCUIT PLUG WITH OPTIONAL PANEL MOUNTS		MOLEX INCORPORATED SHEET NO. 1 OF 1	
	THIS DRAWING CONTAINS INFORMATION THAT IS PROPRIETARY TO MOLEX INCORPORATED AND SHOULD NOT BE USED WITHOUT WRITTEN PERMISSION							
	SIZE D							