

Part Numbers

Package & Chip Type	Line Voltage ¹	Switch Type ²	Output Current	Feature ³
S	24	R	12	-22
		D	25	
		A	40	
S	48	R	25	-22
		D	50	
		A	75	
			95	
			125	
S	60	D	50	
			75	
			95	
			125	

Part Number Example: **S48A25-22**

NOTES

- 1) Line Voltage (nominal): 24 = 240 Vac; 48 = 480 Vac; 60 = 600 Vac
- 2) Switch Type: R = Random turn-on; D = Zero-cross turn-on;
A = AC control, Zero-cross turn-on
- 3) Feature: -22 = 24 Vac control. Available on A type 240 Vac, 25 and 40A models and A type 480 Vac, 25, 50, 125A models

MECHANICAL SPECIFICATION

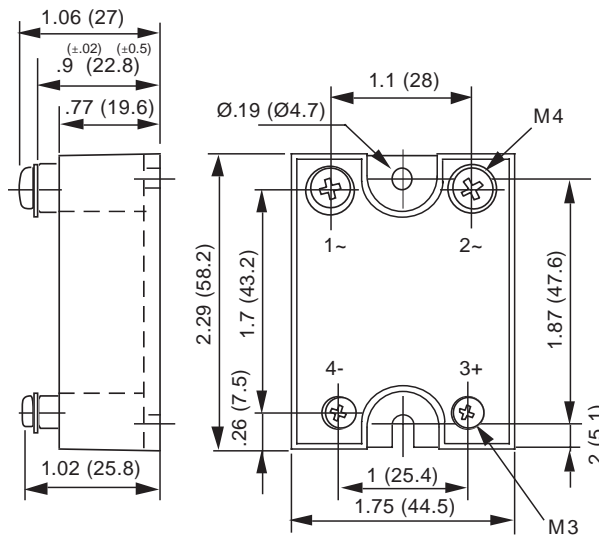

TOLERANCES: ±.01 (0.3) WEIGHT: 3.18 oz. (90g)

Figure 1 — S relays, 12–95 A;
dimensions in inches (mm)
125A model uses larger M5 output screw terminals



FEATURES/BENEFITS

- Industry standard package
- Internal snubber (except S60 models)
- Designed for all types of loads
- AC or DC control available
- Excellent thermal performance
- Tight zero-cross window for low EMI
- High immunity to surges

DESCRIPTION

The Series S single-phase relays are designed for all types of loads. The design incorporates an SCR or triac output. The relays utilize optical isolation to protect the control from load transients. All contain an internal snubber for output protection. High-current models are excellent for motor and phase angle control.

APPLICATIONS

- Heating control
- Motor control
- Uninterruptible power supplies
- Light dimmers
- Industrial and process control
- On/Off controls of AC equipment

APPROVALS

S24 and S48 models are UL recognized.
UL File Number: E128555.

TYPICAL APPLICATION

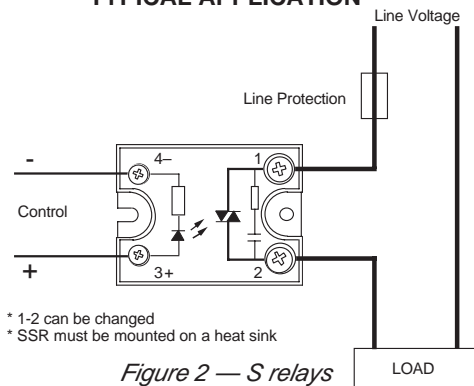

Figure 2 — S relays

INPUT (CONTROL) SPECIFICATION

	Input Type	Min	Max	Units
Control Range				
S24	R	3	30	Vdc
	D	4	30	Vdc
S48	R	4	30	Vdc
	D	5	30	Vdc
S60	D	7	30	Vdc
SxxA	A	90	240	Vac/Vdc
Sxxxx-22	A	17	80	Vac/Vdc

Input Current Range

S	R/D	3	30	mA
S	A	3	8	mA
Sxxxx-22	A	5.6	26	mA

Must Turn-Off Voltage

S	R/D	1	Vdc
S24	A	15	Vac
S48	A	1	Vac
Sxxxx-22		3	Vac

Input Resistance (Typical)

S	R/D	1000	Ohms
S	A	30,000	Ohms
Sxxxx-22		3000	Ohms

Reverse Voltage Protection

S	R/D	30	V
S	A	NA	

CONTROL CHARACTERISTICS

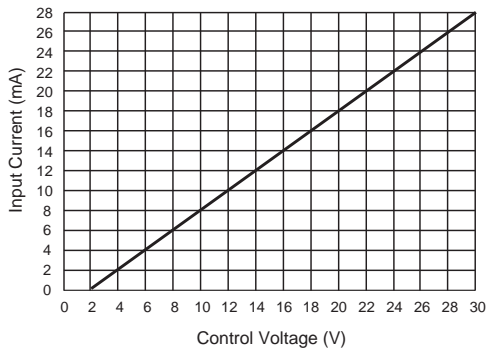

Figure 3a — S48R, S48D and S60D relays

CONTROL CHARACTERISTICS

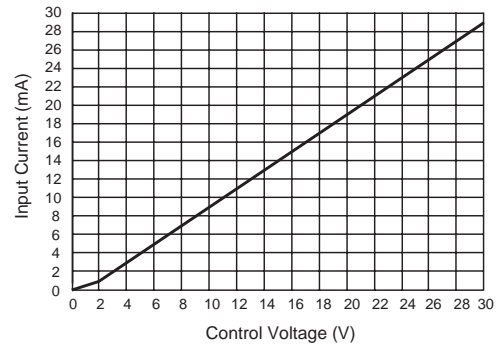

Figure 3b — S24D/R relays

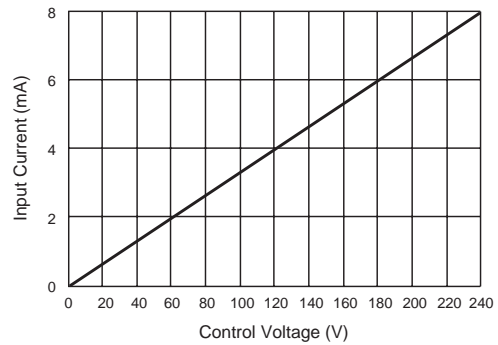

Figure 3c — S24A and S48A relays

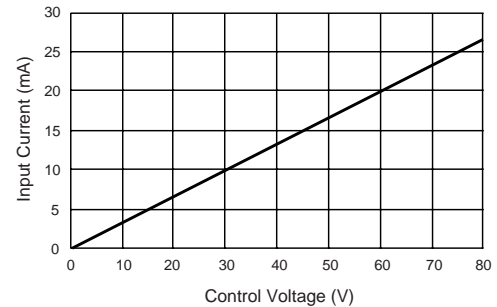

Figure 3d — Sxxxx-22 relays

OUTPUT (LOAD) SPECIFICATION

Input Type	Min	Max	Units
Operating Range			
S24	12	280	Vrms
S48	24	520	Vrms
S60	24	660	Vrms
Peak Voltage			
S24		600	Vpeak
S48		1200	Vpeak
S60		1600	Vpeak
Load Current Range (Resistive)			
12A output current	.005	12	Arms
25A output current	.005	25	Arms
40A output current	.005	40	Arms
50A output current	.005	50	Arms
75A output current	.005	75	Arms
95A output current	.005	95	Arms
125A output current	.005	125	Arms
Inductive Load Current			
12A output current		2.5	Arms
25A output current		5	Arms
40A output current		9	Arms
50A output current		12	Arms
75A output current		16	Arms
95A output current		20	Arms
125A output current		30	Arms
Capacitive Load Current			
S60D50		13	Arms
S60D75		24	Arms
S60D90		36	Arms
S60D125		48	Arms
Maximum Surge Current Rating (Non-Repetitive)			
12A output current		120	A
S24, 25A output current		240	A
S24R25		250	A
S48, 25A output current		230	A
40A output current		350	A
50A output current		550	A
75A output current		1000	A
95A output current		1500	A

OUTPUT (LOAD) SPECIFICATION (Continued)

Input Type	Min	Max	Units
Maximum Surge Current Rating (Non-Repetitive) (Continued)			
125A output current		2000	A
On-State Voltage Drop			
12A output current		1.3	V
25A output current		1.2	V
40A output current		1.4	V
50A output current		1.4	V
75A output current		1.35	V
S60D75		1.3	V
95A output current		1.3	V
S60D90		1.15	V
125A output current		1.3	V
S60D125		1.1	V
Zero-Cross Window (Typical)			
S	R	NA	
S	D/A	±12	Vac
Off-State Leakage Current (60Hz)			
S24		3	mA
S48	D/A	3	mA
S48	R	2.5	mA
S60	A	1	mA
Turn-On Time (60 Hz)			
S	R	0.1	ms
S	D	8.3	ms
S	A	24.9	ms
Turn-Off Time (60 Hz)			
S	R/D	8.3	ms
S	A	24.9	ms
Off-State dv/dt			
All relays		500	V/μs
Maximum di/dt (Non-Repetitive)			
All relays		50	A/μs

OUTPUT (LOAD) SPECIFICATION (Continued)

Input Type	Min	Max	Units
Operating Frequency			
All relays	0.1	440	Hz
I²t for match fusing (<8.3ms)			
12A output current		72	A ² S
S24R25		312	A ² S
S24D/S24A 25A output current		288	A ² S
S48 25A output current		265	A ² S
40A output current		612	A ² S
50A output current		1500	A ² S
75A output current		5000	A ² S
95A output current		11000	A ² S
125A output current		20000	A ² S

ENVIRONMENTAL SPECIFICATION

	Min	Max	Units
Operating Temperature	-40	100	°C
Storage Temperature	-40	100	°C
Input-Output Isolation		4000	Vrms
Output-Case Isolation			
12A output current	2500		Vrms
25A output current	2500		Vrms
40A output current, R	2500		Vrms
40A output current, D	3300		Vrms
40A output current, A	3300		Vrms
50A output current	3300		Vrms
75A output current	3300		Vrms
95A output current	3300		Vrms
125A output current	3300		Vrms

SURGE CURRENT (continued)

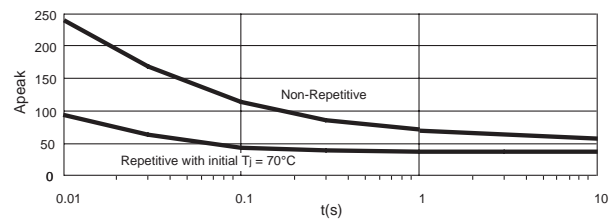

Figure 4b — 25A output current

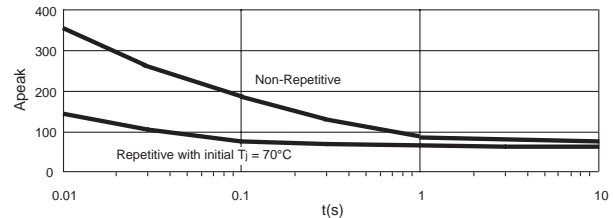

Figure 4c — 40A output current

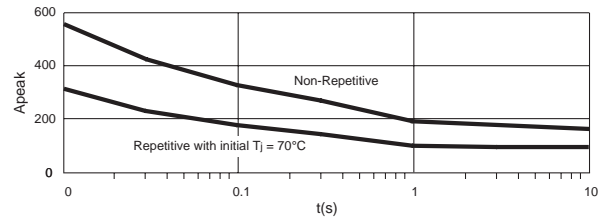

Figure 4d — 50A output current

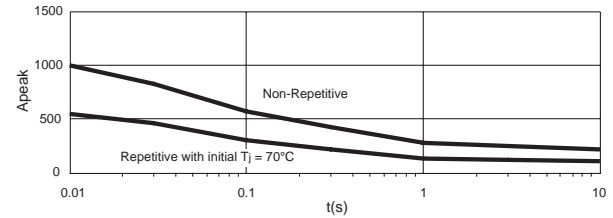

Figure 4e — 75A output current

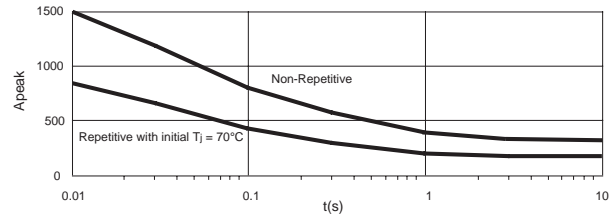

Figure 4f — 95A output current

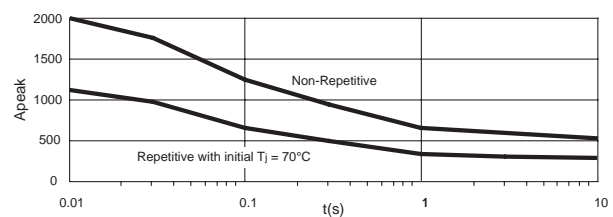

Figure 4g — 125A output current

SURGE CURRENT

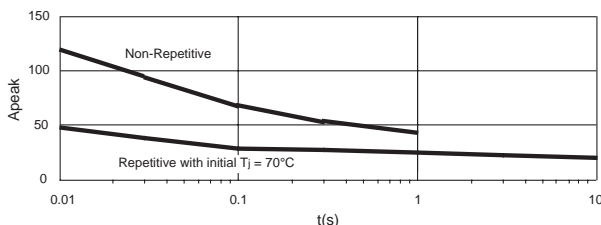

Figure 4a — 12A output current

THERMAL CHARACTERISTICS

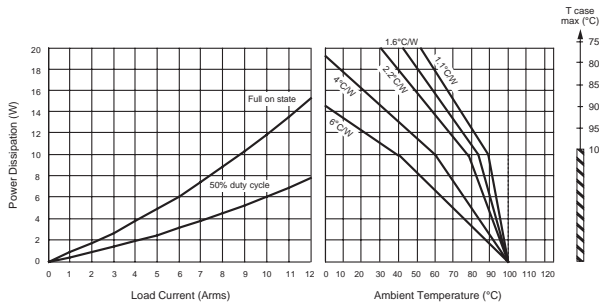

Figure 5a — 12A output current

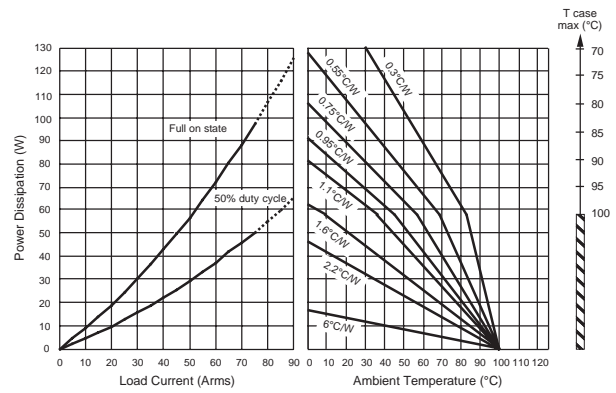

Figure 5e — 75A output current

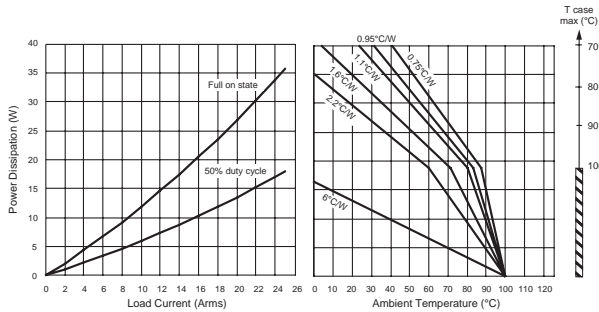

Figure 5b — 25A output current

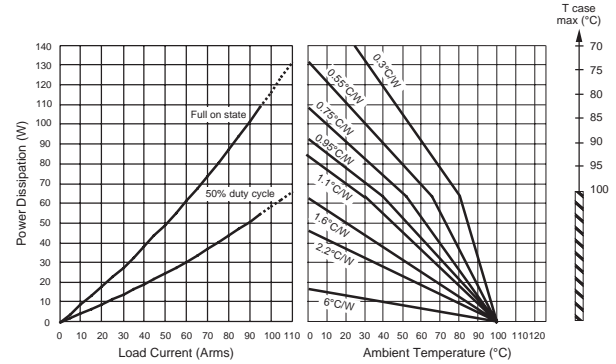

Figure 5f — 95A output current

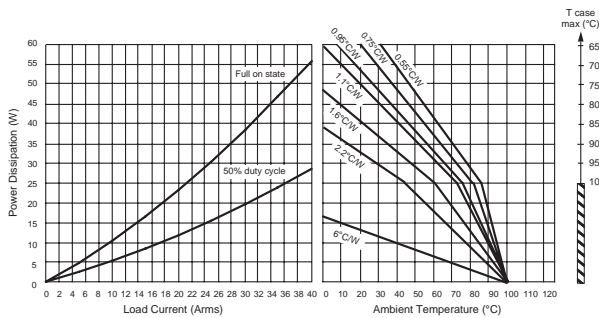

Figure 5c — 40A output current

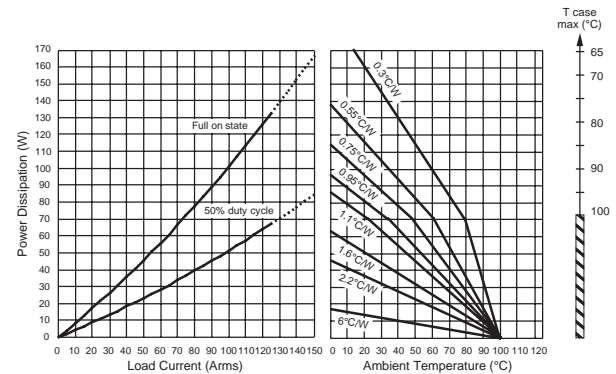

Figure 5g — 125A output current

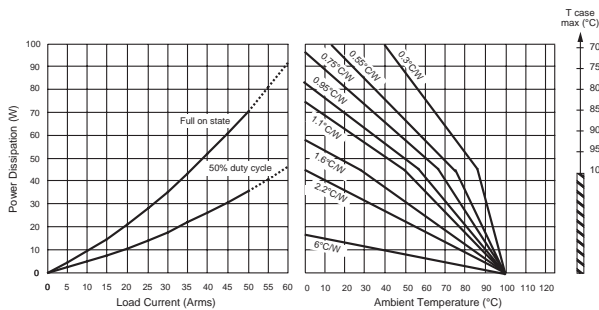

Figure 5d — 50A output current

- NOTES:
1. Electrical specifications measured at 25°C unless otherwise specified.
 2. For 800Hz applications, contact factory.
 3. For additional/custom options, contact factory.

OPTIONAL ADD-ONS

- Please order add-ons separately:
- -12 — Thermal pad installed.
 - -14 — Plastic touch-proof cover.