

**PLEASE CHECK WWW.MOLEX.COM FOR LATEST PART INFORMATION**

**Part Number:** [1300980069](#)  
**Status:** **Active**  
**Overview:** [brad wire mesh grips](#)  
**Description:** MAX-LOC® Strain Relief Cord-Sealing Grip, 1/2" NPT, Straight Female, Cable Diameter 9.53-11.10mm (.375-.437")

**Documents:**

[Drawing \(PDF\)](#) [RoHS Certificate of Compliance \(PDF\)](#)

**Agency Certification**

CSA LR32159  
 UL E76954

**General**

Product Family Cable Grips  
 Series [130098](#)  
 Eye Type N/A  
 Insulated No  
 NEMA Rating NEMA 3R  
 O-Ring No  
 Overview [brad wire mesh grips](#)  
 Product Name MAX-LOC®  
 Type Strain Relief Grips  
 Use With [1300990143](#) 1/2" NPT MAX-LOC® Lock Nut  
 Woodhead Yes

**Physical**

Approximate Break Strength N/A  
 Bale Length N/A  
 Body Style Straight  
 Cable Diameter 9.53-11.10mm (.375-.437")  
 Color - Grommet Green  
 Gender Female  
 Material - Body Nylon  
 Material - Grip N/A  
 Mesh Length N/A  
 Number of Holes 2  
 Strain Relief Force 35 lbs  
 Thread Size 1/2" NPT

**Material Info**

Old Part Number 5528

**Reference - Drawing Numbers**

Sales Drawing SD-130098-003

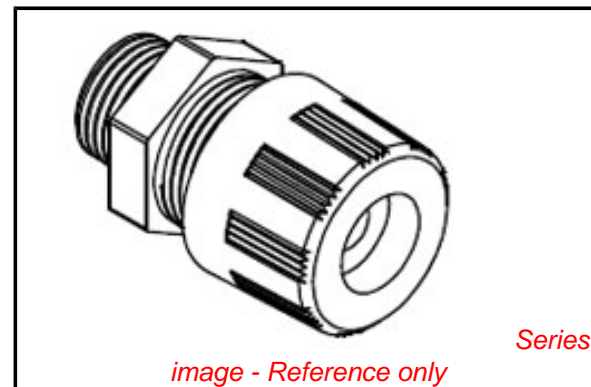

**EU RoHS**

**ELV and RoHS  
 Compliant  
 REACH SVHC  
 Not Reviewed  
 Halogen-Free  
 Status  
 Not Reviewed**

**China RoHS**



**Need more information on product  
 environmental compliance?**

Email [productcompliance@molex.com](mailto:productcompliance@molex.com)  
 For a multiple part number RoHS Certificate of  
 Compliance, [click here](#)

Please visit the [Contact Us](#) section for any  
 non-product compliance questions.

**Search Parts in this Series**  
[130098Series](#)

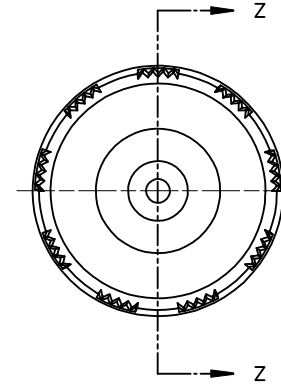
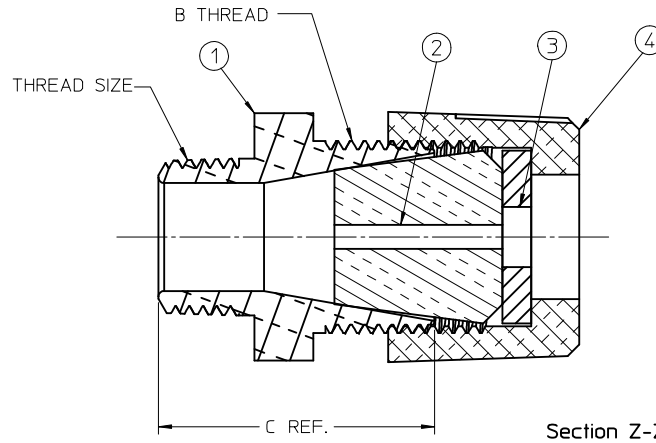
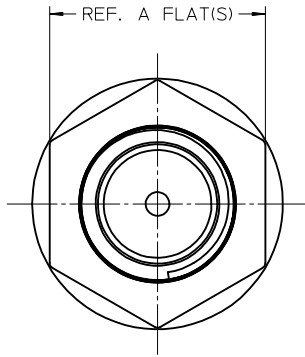

VIEW SCALE: 1:1

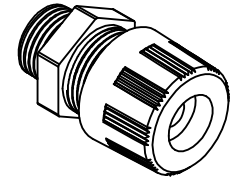

MATERIAL NO.	OLD PART NO.	THREAD SIZE	CABLE DIA. RANGE	A	B	C	ITEM 1 COLOR	ITEM 2 MATERIAL	ITEM 2 COLOR	ITEM 3 MATERIAL	ITEM 4 MATERIAL	ITEM 4 COLOR
1300980024	5398	1/4" NPT	.075-.135 / 1.91-3.43	.69 / 17.5	1/2-18	.92 / 23.4	GRAY	NITRILE	BLACK	NYLON	NYLON	GRAY
1300980025	5400		.135-.200 / 3.43-5.08						GRAY			
1300980026	5402		.200-.265 / 5.08-6.73						GREEN			
1300980027	5500	3/8" NPT	.125-.187 / 3.18-4.75	1.00 / 25.4	7/8-14	1.25 / 31.8	GRAY	NITRILE	YELLOW	HDPE	NYLON	GRAY
1300980029	5502		.187-.250 / 4.75-6.35						ORANGE			
1300980031	5504		.250-.312 / 6.35-7.92						BLACK			
1300980032	5506		.312-.375 / 7.92-9.53						GRAY			
1300980034	5508		.375-.437 / 9.53-11.10						GREEN			
1300980036	5518	1/2" NPT	.062-.125 / 1.57-3.18	1.13 / 28.7	1"-14	1.44 / 36.6	GRAY	NITRILE	BLACK	HDPE	NYLON	GRAY
1300980041	5520		.125-.187 / 3.18-4.75						YELLOW			
1300980046	5522		.187-.250 / 4.75-6.35						ORANGE			
1300980052	5524		.250-.312 / 6.35-7.92						BLACK			
1300980061	5526		.312-.375 / 7.92-9.53						GRAY			
1300980069	5528		.375-.437 / 9.53-11.10						GREEN			
1300980076	5530		.437-.500 / 11.10-12.70						ORANGE			
1300980082	5532		.500-.562 / 12.70-14.27						BLACK			
1300980235	5620	3/4" NPT	.187-.250 / 4.75-6.35	1.38 / 35.1	1 1/4-14	1.69 / 42.9	GRAY	NITRILE	ORANGE	HDPE	NYLON	GRAY
1300980236	5622		.250-.375 / 6.35-9.53						GRAY			
1300980225	5624		.375-.437 / 9.53-11.10						GREEN			
1300980096	5536		.437-.562 / 11.10-14.27						BLACK			
1300980103	5538		.500-.625 / 12.70-15.87						GRAY			
1300980112	5540		.562-.687 / 14.27-17.45						GREEN			
1300980118	5542		.625-.750 / 15.87-19.05						ORANGE			

NOTES:

1. MATERIAL: SEE TABLE
2. FINISHES: SEE TABLE
3. NEMA RATING: NEMA 3R
4. RoHS COMPLIANT: YES

4	1	COMPRESSION NUT	SEE CHART	SEE CHART
3	1	COMPRESSION RING	SEE CHART	NATURAL (WHITE)
2	1	GROMMET	SEE CHART	SEE CHART
1	1	STRAIGHT MALE BODY	NYLON	SEE CHART
ITEM	QTY.	DESCRIPTION	MATERIAL	FINISH

RELEASED  
EC NO: MNAZ009-0534  
DRWRSTONE 2009/03/11  
CHKDDB WOODMAN  
APPR: JF MURPHY 2009/04/17

QUALITY SYMBOLS  
▽=0  
▽=0

DESCRIPTION  
REV: A

GENERAL TOLERANCES (UNLESS SPECIFIED)

	mm	INCH
4 PLACES	± .005	± .0005
3 PLACES	± .005	± .0005
2 PLACES	± .010	± .0010
1 PLACE	± 0.3	± .0125

ANGULAR ±1/2°

DRAFT WHERE APPLICABLE  
MUST REMAIN  
WITHIN DIMENSIONS

DIMENSION STYLE  
IN/MM

DRAWN BY DATE  
R. STONE 2009/02/23

CHECKED BY DATE  
B. WOODMAN 2009/02/27

APPROVED BY DATE  
J. MURPHY 2009/03/03

MATERIAL NO.  
SEE CHART

SIZE  
C

SCALE 2:1

DESIGN UNITS INCH

THIRD ANGLE PROJECTION

TITLE  
MAX-LOC STRAIN RELIEF  
CORD GRIP, STRAIGHT MALE  
NO O-RING

MOLEX MOLEX INCORPORATED

DOCUMENT NO. SD-130098-003

SHEET NO. 1 OF 1

THIS DRAWING CONTAINS INFORMATION THAT IS PROPRIETARY TO MOLEX INCORPORATED AND SHOULD NOT BE USED WITHOUT WRITTEN PERMISSION