

SPECIFICATION FOR TDK MULTILAYER CERAMIC CHIP CAPACITORS

Date issue : Jul. 2. '09

TDK P/N

C1005	X7S	2A	103	M	T	XXXX
1)	2)	3)	4)	5)	6)	7)

No.	Segment	Detail	Comments
1	Case Size	1.00 x 0.50 mm	See below for dimensions.
2	Temperature Characteristics	-55 to +125degC +/-22%	Class II : Conforms to EIA 198
3	Rated Voltage	100V	DC
4	Capacitance	10,000pF	1.0+/-0.2Vrms, 1kHz+/-10%
5	Capacitance Tolerance	M : +/-20%	Conforms to IEC 384-9
6	Packaging Style	Tape and Reel, 8mm	EIA 481 Format
7	TDK internal Code	XXXX	(Internal TDK use only)
-	Dissipation Factor	0.05 Max.	1.0+/-0.2Vrms, 1kHz+/-10%
-	Insulation Resistance	10,000Mohm min.	apply rated voltage for 60s

Condition for life : Apply 1.5 x rated voltage at maximum operating temperature +/-2degC for 1,000+48, 0h.

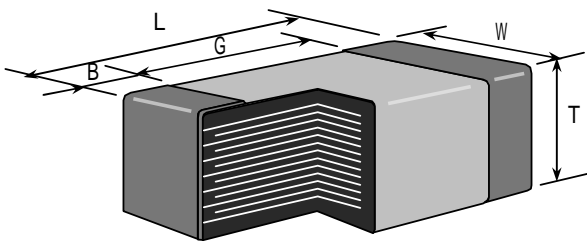
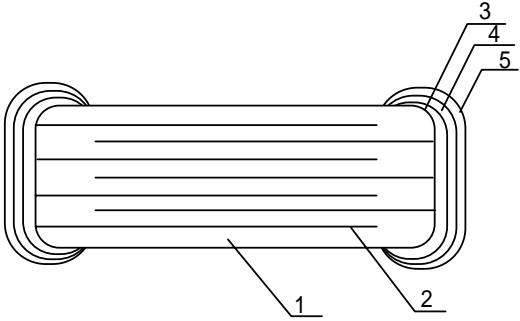
Physical Dimensions		Material System		
				
Symbol	Dimensions(mm)	No.	Name	Material
L	1.00 +/- 0.05	1	Dielectric	BaTiO3
W	0.50 +/- 0.05	2	Electrode	Ni
T	0.50 +/- 0.05	3	Termination	Cu
B	0.10 min.	4		Ni
G	0.30 min.	5		Sn

1 This datasheet is to be used for reference purposes only and is subject to change by TDK without notice.

It reflects an overview of the product characteristics/performance for the particular part number. For product specification information, please refer to TDK's general product specification. Please note that this standard part is not designed or warranted to meet any specifications of any intermediate or end user different from or in addition to the specifications set forth in TDK's general product specification. Note also that this standard part has not been specially designed or manufactured for, nor is it intended or warranted for use in, or permitted to be resold for, specialized applications such as aviation, medical, and/or governmental/military applications (collectively, "Excluded Applications").



is a trademark or registered trademark of TDK Corporation.