

**3.3V 600mA/250mA<sup>+</sup> Low Dropout Regulator****Features**

- Dropout voltage typically 0.65V/0.25V @ I<sub>o</sub> = 600mA/ 250mA<sup>+</sup>
- Output current in excess of 600mA/250mA<sup>+</sup>
- Output voltage accuracy ±2%
- Quiescent current, typically 0.3mA
- Internal short circuit current limit
- Internal over temperature protection

**General Description**

The G910/G911 positive 3.3V voltage regulator features the ability to source 600mA/250mA<sup>+</sup> of output current with a dropout voltage of typically 0.65V/0.25V. A low quiescent current is provided. The typical quiescent current is 0.3mA.

[<sup>+</sup> For μTO-92 & TO-92 package]

Familiar regulator features such as over temperature and over current protection circuits are provided to prevent it from being damaged by abnormal operating conditions.

**Ordering Information**

ORDER NUMBER	ORDER NUMBER (Pb free)	TEMP. RANGE	PACKAGE	PIN OPTION		
				1	2	3
G910T21U	G910T21Uf	-40°C~85°C	SOT-89	V <sub>OUT</sub>	GND	V <sub>IN</sub>
G911T24U	G911T24Uf	-40°C~85°C	SOT-89	GND	V <sub>IN</sub>	V <sub>OUT</sub>
G910T65U	G910T65Uf	-40°C~85°C	SOT-223	V <sub>IN</sub>	GND	V <sub>OUT</sub>
G910TD1B	G910TD1Bf	-40°C~85°C	TO-92	V <sub>OUT</sub>	GND	V <sub>IN</sub>
G911TD4B	G911TD4Bf	-40°C~85°C	TO-92	GND	V <sub>IN</sub>	V <sub>OUT</sub>
G910T81B	G910T81Bf	-40°C~85°C	μTO-92	V <sub>OUT</sub>	GND	V <sub>IN</sub>
G911T84B	G911T84Bf	-40°C~85°C	μTO-92	GND	V <sub>IN</sub>	V <sub>OUT</sub>
G911T85B	G911T85Bf	-40°C~85°C	μTO-92	V <sub>IN</sub>	GND	V <sub>OUT</sub>

\* For other package types, pin options and package, please contact us at sales@gmt.com.tw

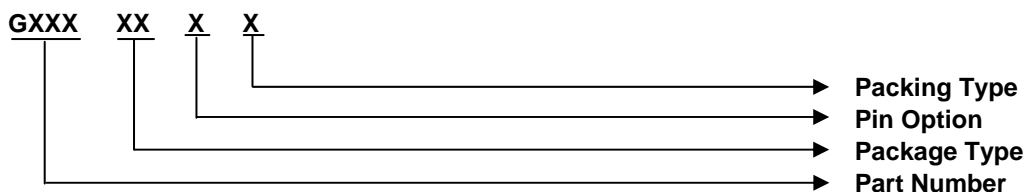
**Order Number Identification****PACKAGE TYPE**

T2 : SOT-89  
 T6 : SOT-223  
 T8 : μTO-92  
 TD : TO-92

**PIN OPTION**

1	2	3
1 : V <sub>OUT</sub>	GND	V <sub>IN</sub>
2 : V <sub>OUT</sub>	V <sub>IN</sub>	GND
3 : GND	V <sub>OUT</sub>	V <sub>IN</sub>
4 : GND	V <sub>IN</sub>	V <sub>OUT</sub>
5 : V <sub>IN</sub>	GND	V <sub>OUT</sub>
6 : V <sub>IN</sub>	V <sub>OUT</sub>	GND

**PACKING**

U & D : Tape & Reel Direction  
 B : Bag

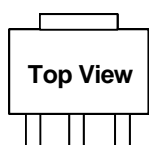
**Package Type**

SOT-89 · 223

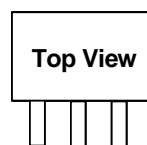

μTO-92 · TO-92

**Typical Application**

[Note 4]: Type of C<sub>OUT</sub>

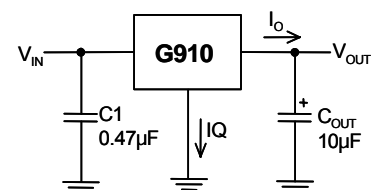



<b>Absolute Maximum Ratings</b>	(Note 1)
Input Voltage	7V
Power Dissipation Internally Limited	(Note2)
Maximum Junction Temperature	150°C
Storage Temperature Range	-65°C ≤ T <sub>J</sub> ≤ +150°C
Reflow Temperature (soldering, 10sec)	260°C
Thermal Resistance Junction to Ambient, (θ <sub>JA</sub> )	
SOT-89	173°C/W <sup>(1)</sup>
SOT-223	148°C/W <sup>(1)</sup>
μTO-92, TO-92	159°C/W <sup>(1)</sup>
Thermal Resistance Junction to Case, (θ <sub>JC</sub> )	
SOT-89	25°C/W
SOT-223	22°C/W

<b>Operating Conditions</b>	(Note 1)
Input Voltage	4V ~ 6.5V
Temperature Range	-40°C ≤ T <sub>A</sub> ≤ 85°C

Note <sup>(1)</sup>: See Recommended Minimum Footprint.

## Electrical Characteristics

V<sub>IN</sub> = 5V, I<sub>O</sub> = 600mA/250mA+, C<sub>IN</sub> = 10μF, C<sub>OUT</sub> = 10μF. All specifications apply for T<sub>A</sub> = T<sub>J</sub> = 25°C. [Note 3]

PARAMETER	CONDITION	MIN	TYP	MAX	UNIT	
Output Voltage	10mA ≤ I <sub>O</sub> ≤ 600mA	3.234	3.3	3.366	V	
	10mA ≤ I <sub>O</sub> ≤ 250mA <sup>+</sup>					
Line Regulation	4V ≤ V <sub>IN</sub> ≤ 6V, I <sub>O</sub> = 10mA	---	15	---	mV	
Load Regulation	10mA ≤ I <sub>O</sub> ≤ 600mA	---	20	---	mV	
	10mA ≤ I <sub>O</sub> ≤ 250mA <sup>+</sup>	---	10	---		
Quiescent Current	V <sub>IN</sub> = 5V	---	0.3	---	mA	
Ripple Rejection	f <sub>i</sub> = 120 Hz, 1V <sub>P-P</sub> , I <sub>O</sub> = 100mA	---	47	---	dB	
Dropout Voltage	I <sub>O</sub> = 600mA	---	0.65	---	V	
	I <sub>O</sub> = 250mA <sup>+</sup>	---	0.25	---		
Output Current	Continuous Test T <sub>A</sub> = 25°C, T <sub>J</sub> < 125°C, V <sub>OUT</sub> within ±2% (Note 2)	V <sub>IN</sub> = 4.5V, mounted on SOT-89 recom- mended minimum footprint	---	600	---	mA
		V <sub>IN</sub> = 5.2V, μTO-92 & TO-92 package 0.53 inch leads soldered to PC Board	---	250 <sup>+</sup>	---	
Short Circuit Current		---	0.65	---	A	
Current Limit			0.8		A	
Over Temperature		---	145	---	°C	

[<sup>+</sup> for μTO-92 & TO-92 Package]

**Note 1:** Absolute Maximum Ratings are limits beyond which damage to the device may occur. Operating Conditions are conditions under which the device functions but the specifications might not be guaranteed. For guaranteed specifications and test conditions see the Electrical Characteristics.

**Note2:** The maximum power dissipation is a function of the maximum junction temperature, T<sub>Jmax</sub>; total thermal resistance, θ<sub>JA</sub>, and ambient temperature T<sub>A</sub>. The maximum allowable power dissipation at any ambient temperature is T<sub>Jmax</sub>-T<sub>A</sub> / θ<sub>JA</sub>. If this dissipation is exceeded, the die temperature will rise above 150°C and IC will go into thermal shutdown. For the G910 in μTO-92, TO-92, θ<sub>JA</sub> is 159°C/W ;in the SOT-223 package is 148°C/W and SOT-89 package is 173°C/W (See Recommended Minimum Footprint). The safe operation in TO-92 & μTO-92 package, it can see "Typical Performance Characteristics" (Safe Operating Area).

**Note3:** Low duty pulse techniques are used during test to maintain junction temperature as close to ambient as possible.

**Note4:** The type of output capacitor should be tantalum or aluminum.

## Definitions

### Dropout Voltage

The input/output Voltage differential at which the regulator output no longer maintains regulation against further reductions in input voltage. Measured when the output drops 100mV below its nominal value, dropout voltage is affected by junction temperature, load current and minimum input supply requirements.

### Line Regulation

The change in output voltage for a change in input voltage. The measurement is made under conditions of low dissipation or by using pulse techniques such that average chip temperature is not significantly affected.

### Load Regulation

The change in output voltage for a change in load current at constant chip temperature. The measurement is made under conditions of low dissipation or by using pulse techniques such that average chip temperature is not significantly affected.

### Maximum Power Dissipation

The maximum total device dissipation for which the regulator will operate within specifications.

### Quiescent Bias Current

Current which is used to operate the regulator chip and is not delivered to the load.



## Typical Performance Characteristics

$V_{IN}=5V$ ,  $C_{IN}=1\mu F$ ,  $C_{OUT}=10\mu F$ ,  $T_A=25^\circ C$ , unless otherwise noted.)

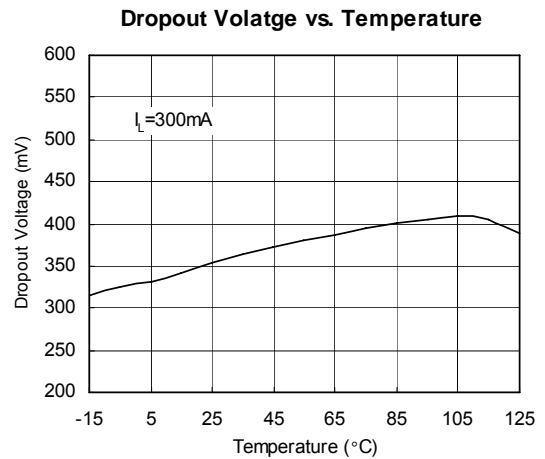
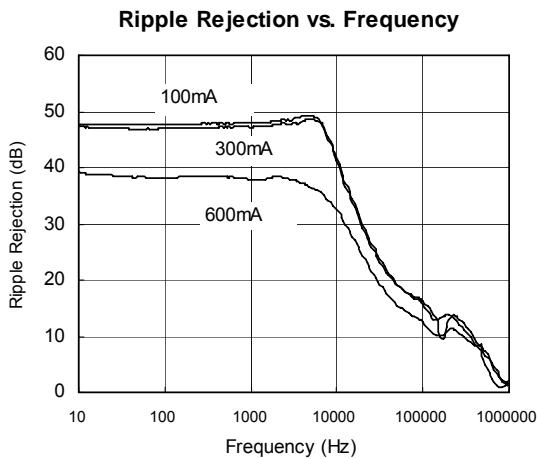
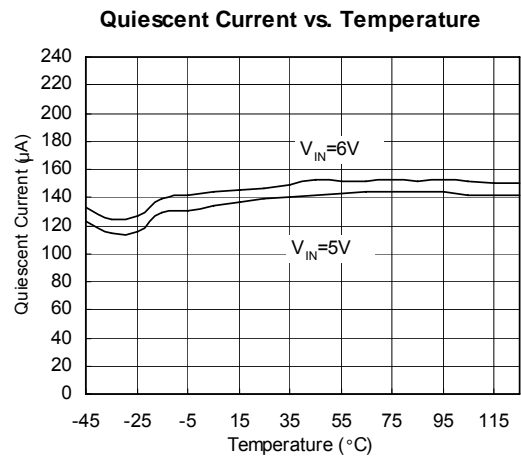
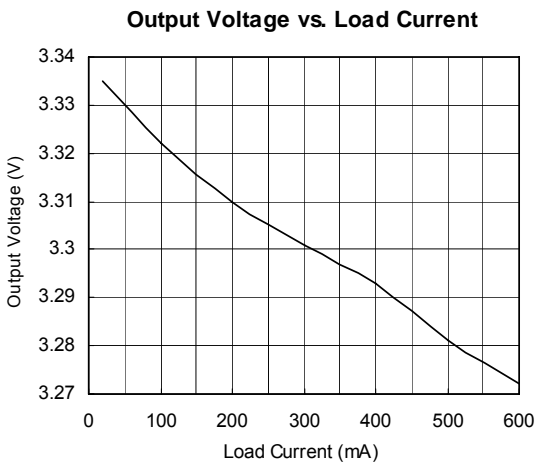
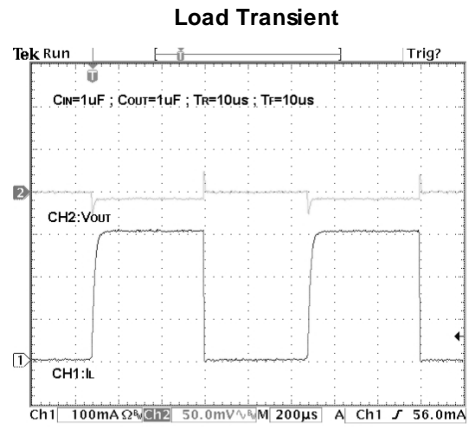
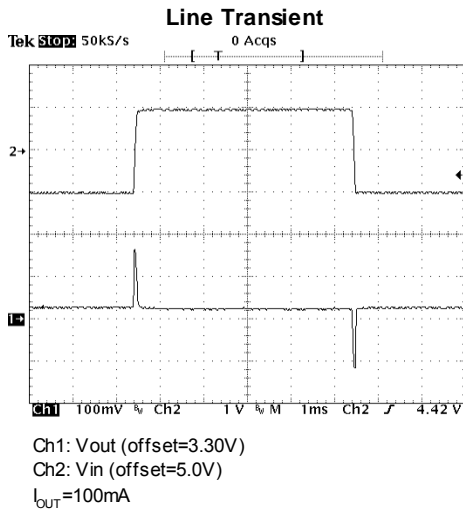



## Typical Performance Characteristics (continued)

### Line Transient (SOT-89)

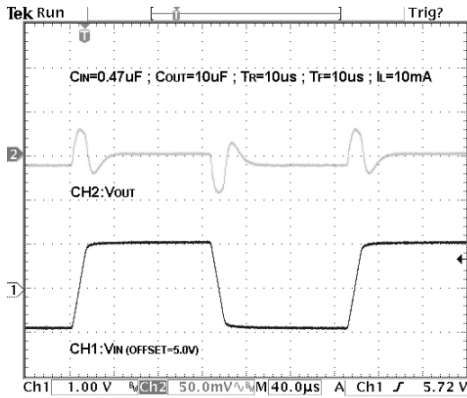

### Load Transient (SOT-89)

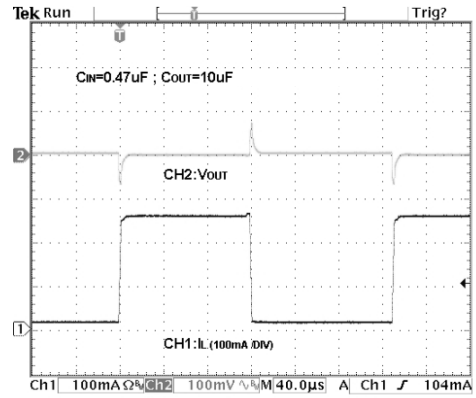

### Short Circuit Current (SOT-89)

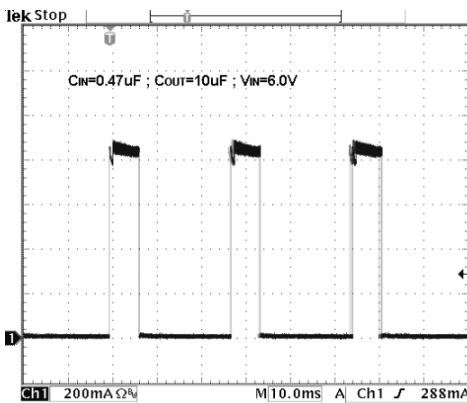

### Start-UP (SOT-89)

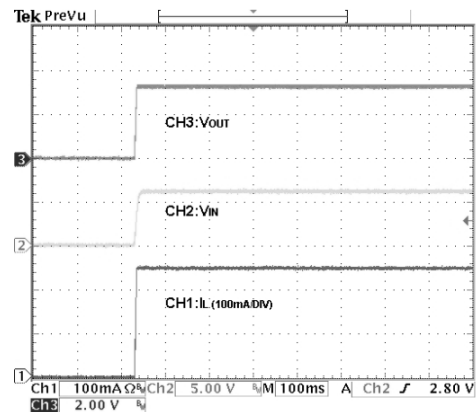

### Overcurrent Protection Characteristics (SOT-89)

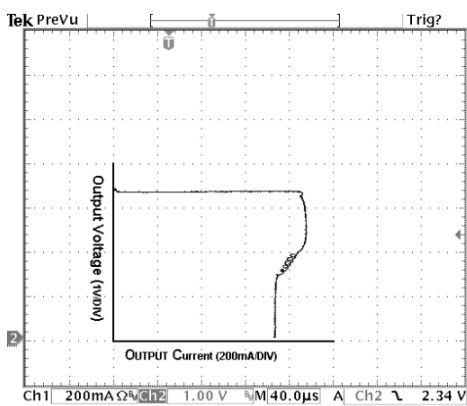

### Ripple Rejection (SOT-89)

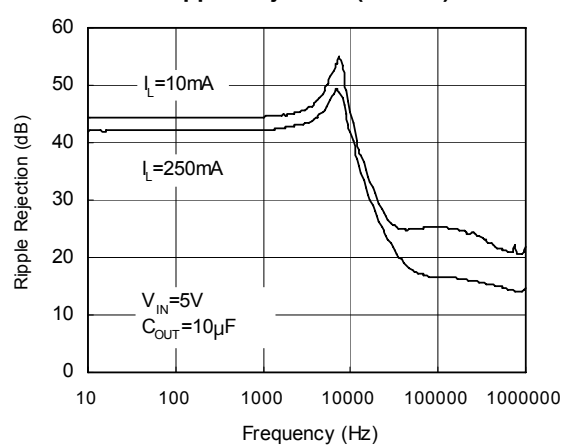



Typical Performance Characteristics (continued)

Quiescent Current vs. Temperature (SOT-89)

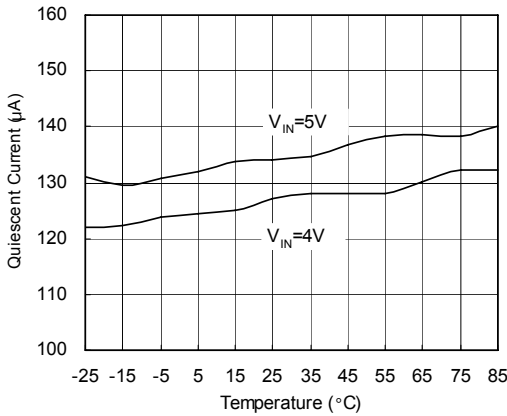

Dropout Voltage vs. IL (SOT-89)

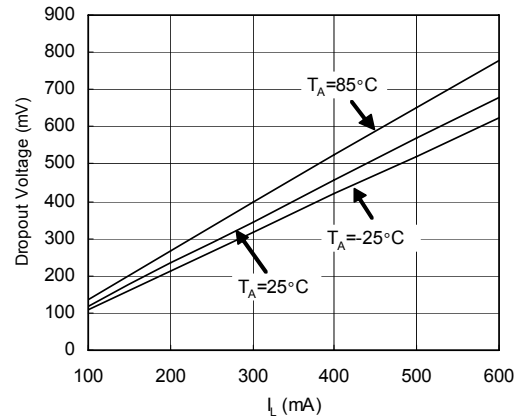

Output Voltage vs. Temperature (SOT-89)

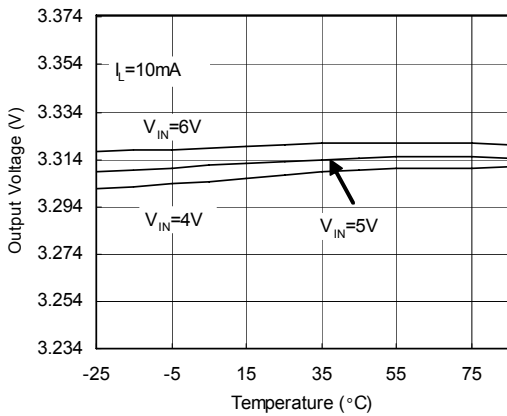

Output Voltage vs. VIN (SOT-89)

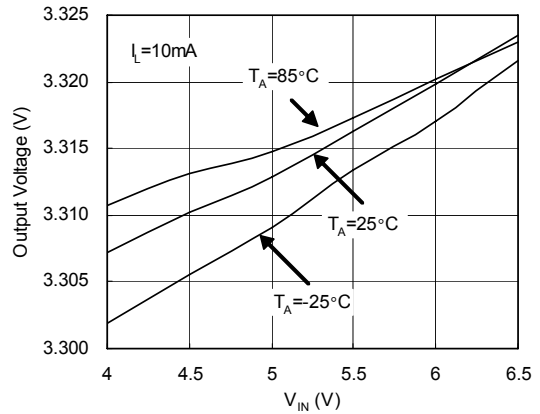

Safe Operating Area of µTO-92 & TO-92

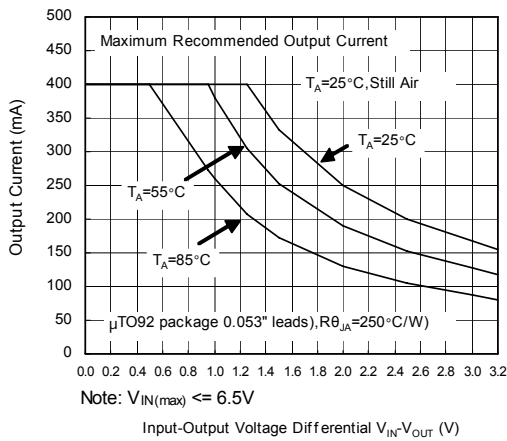

Maximum Power Dissipation of µTO-92 & TO-92

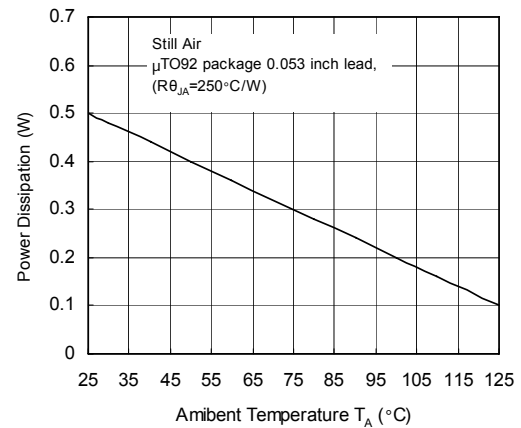

## Typical Performance Characteristics (continued)

**SOT-223 Max. Power Dissipation vs. PCB Top Copper Area**  
 $T_{AMB} = 25^{\circ}C$  ; Still Air

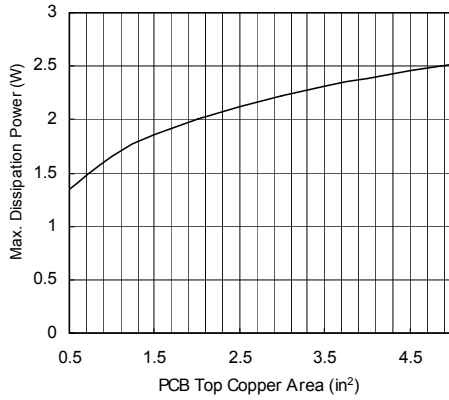

**SOT-223 Max. Power Dissipation vs.  $T_{AMB}$  (still air)**  
 ( Different PCB Top Copper Area )

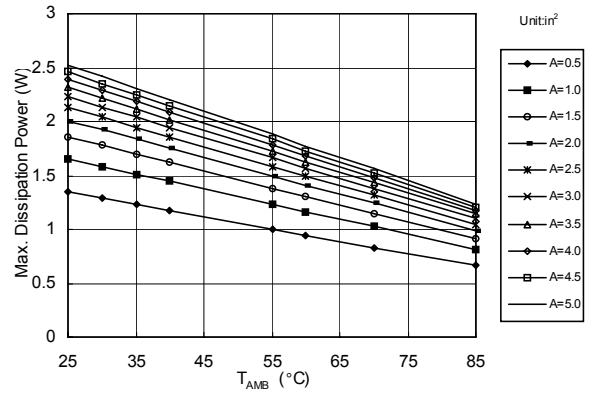

**SOT-89 Max. Power Dissipation vs. PCB Top Copper Area**  
 $T_{AMB} = 25^{\circ}C$  ; Still Air

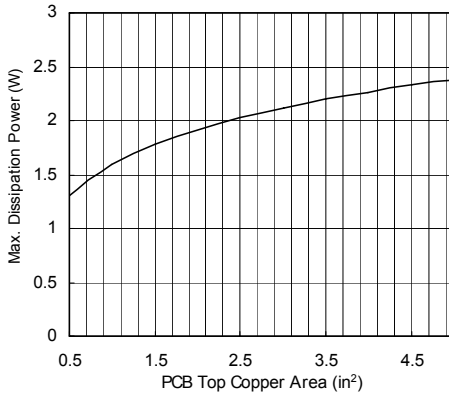

**SOT-89 Max. Power Dissipation vs.  $T_{AMB}$  (still air)**  
 ( Different PCB Top Copper Area )

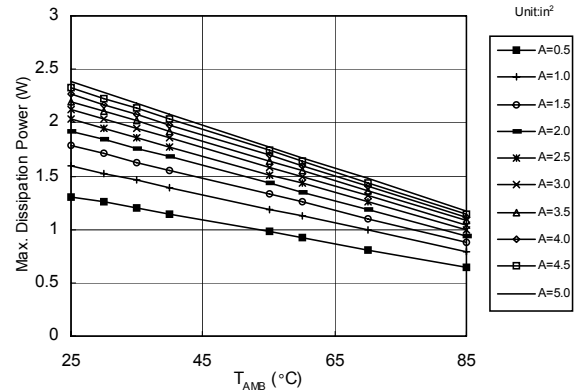

## Recommended Minimum Footprint

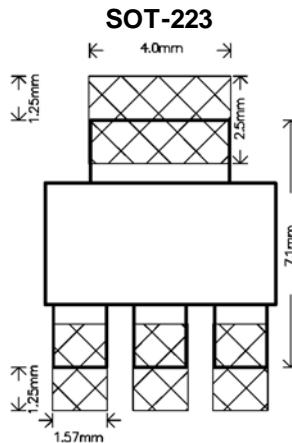
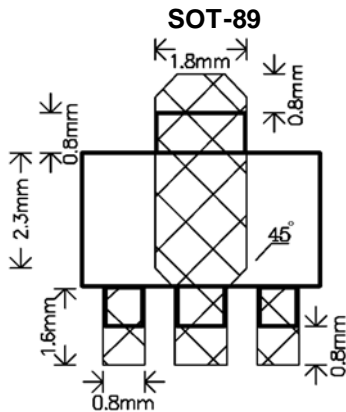



Package Information

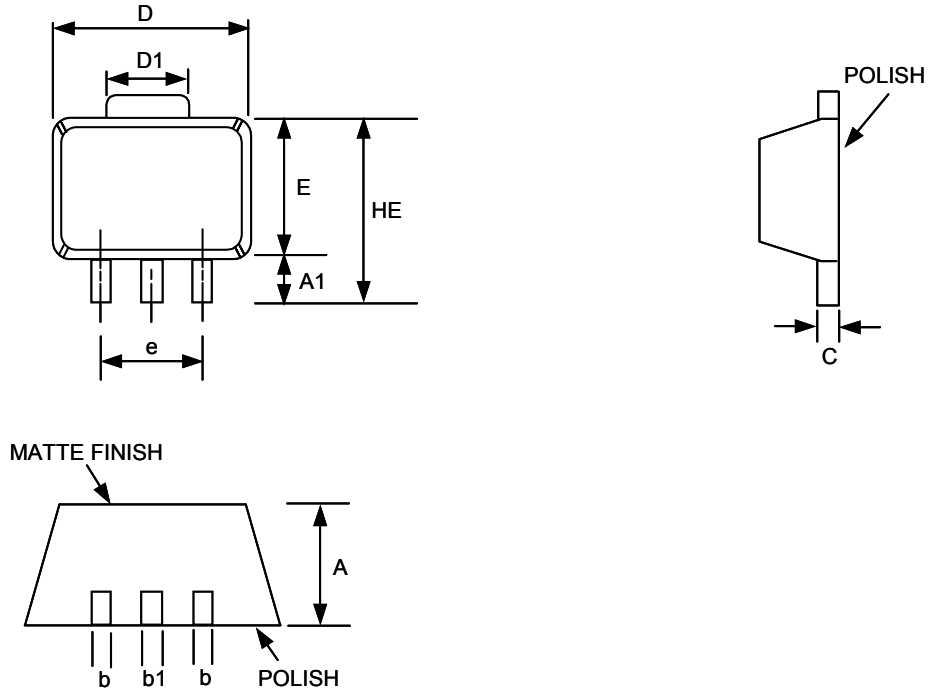

SOT-89 (T2) Package

SYMBOL	DIMENSIONS IN MILLIMETER			DIMENSIONS IN INCH		
	MIN	NOM	MAX	MIN	NOM	MAX
A	1.40	1.50	1.60	0.055	0.059	0.063
A1	0.80	1.04	----	0.031	0.041	----
b	0.36	0.42	0.48	0.014	0.016	0.018
b1	0.41	0.47	0.53	0.016	0.018	0.020
C	0.38	0.40	0.43	0.014	0.015	0.017
D	4.40	4.50	4.60	0.173	0.177	0.181
D1	1.40	1.60	1.75	0.055	0.062	0.069
HE	----	----	4.25	----	----	0.167
E	2.40	2.50	2.60	0.094	0.098	0.102
e	2.90	3.00	3.10	0.114	0.118	0.122

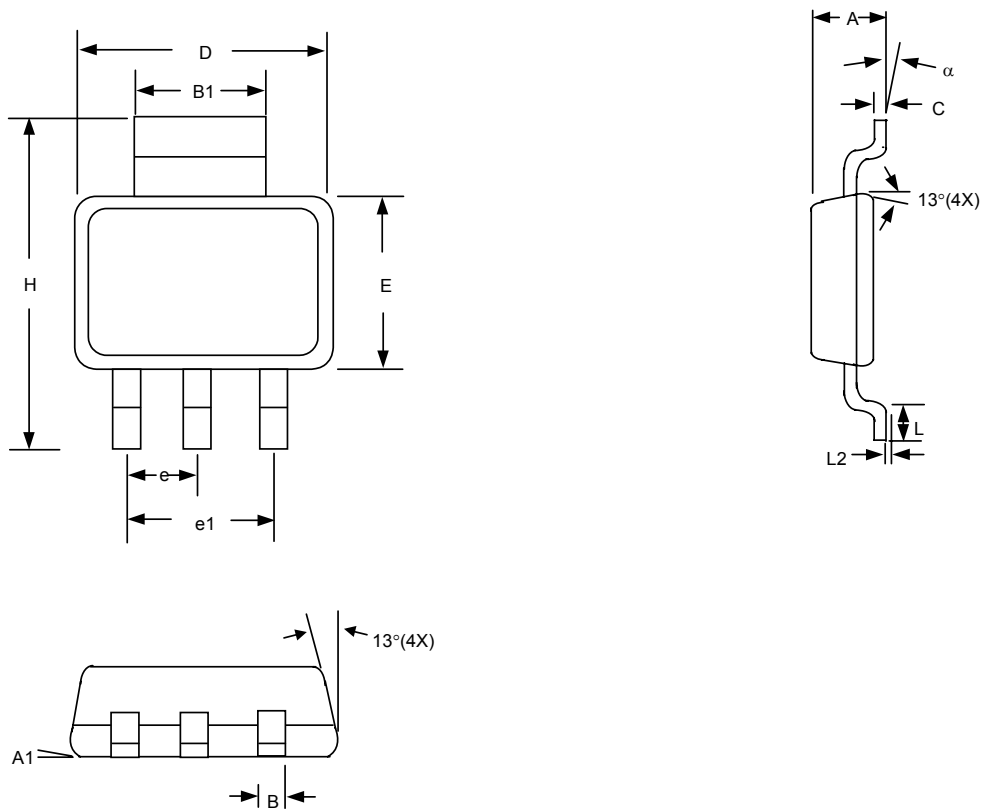

SOT-223 (T6) Package

SYMBOL	MILLIMETER		INCH	
	MIN	MAX	MIN	MAX
A	1.55	1.80	0.061	0.071
A1	0.02	0.12	0.0008	0.0047
B	0.60	0.80	0.024	0.031
B1	2.90	3.10	0.114	0.122
C	0.24	0.32	0.009	0.013
D	6.30	6.70	0.248	0.264
E	3.30	3.70	0.130	0.146
e	2.30 BSC		0.090 BSC	
e1	4.60 BSC		0.181 BSC	
H	6.70	7.30	0.264	0.287
L	0.90 MIN		0.036 MIN	
L2	0.06 BSC		0.0024 BSC	
$\alpha$	0°	10°	0°	10°



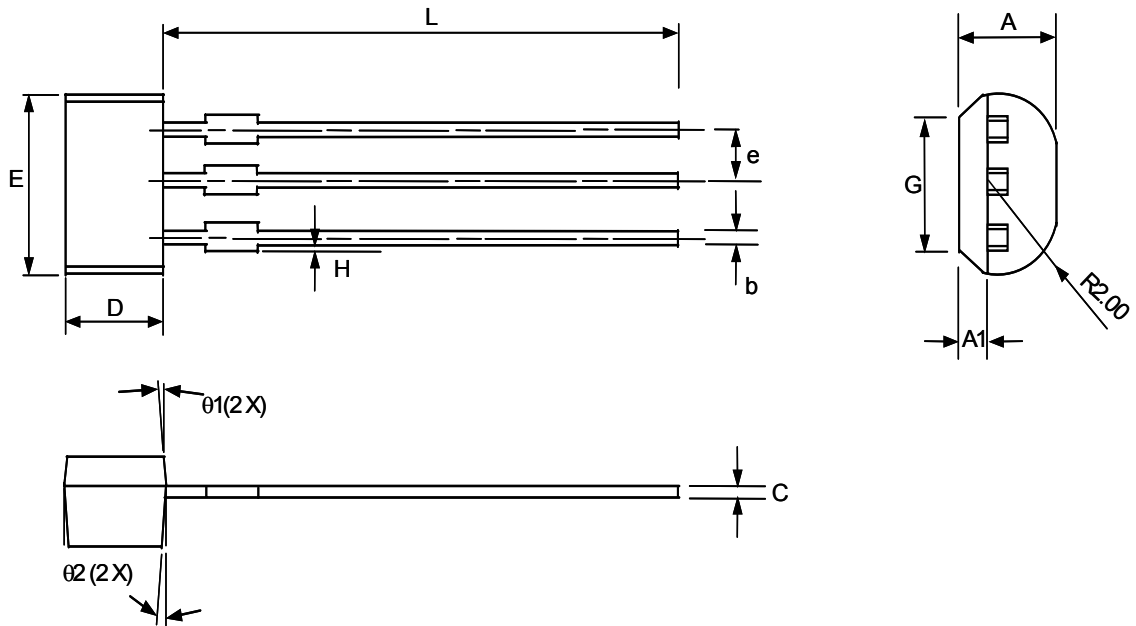

μTO-92 (T8) Package

SYMBOL	DIMENSIONS IN MILLIMETER			DIMENSIONS IN INCH		
	MIN	NOM	MAX	MIN	NOM	MAX
A	2.40	2.50	2.60	0.094	0.098	0.102
A1	0.70	0.80	0.90	0.028	0.032	0.036
b	0.35	0.45	0.55	0.014	0.018	0.022
C	----	0.40	----	----	0.016	----
D	2.80	3.00	3.20	0.110	0.118	0.126
E	3.80	4.00	4.20	0.149	0.157	0.165
e	----	1.27	----	----	0.050	----
F	1.91	2.11	2.31	0.075	0.083	0.091
G	3.35	3.55	3.75	0.132	0.140	0.148
H	0.00	----	0.15	0.000	----	0.006
L	13.80	14.00	14.20	0.543	0.551	0.559
θ1	----	2°	----	----	2°	----
θ2	----	5°	----	----	5°	----

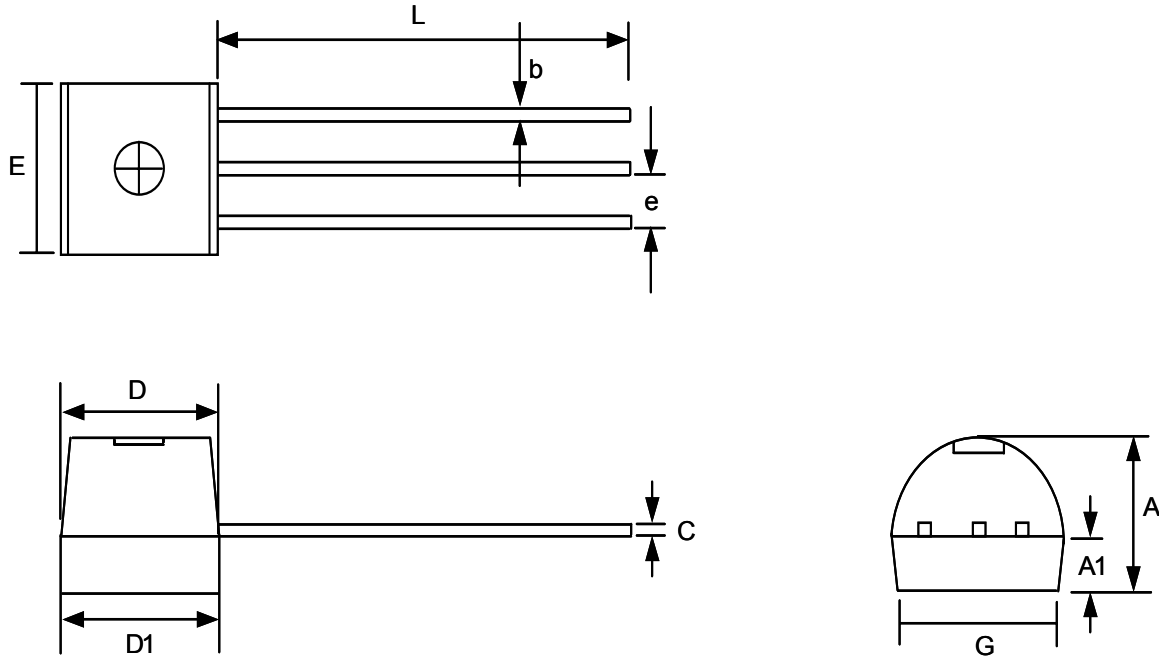

TO-92 (TD) Package

SYMBOL	MILLIMETER		INCH	
	MIN	MAX	MIN	MAX
A	3.35	3.86	0.132	0.152
A1	1.0414	1.55	0.041	0.061
b	0.254	0.508	0.010	0.020
E	4.34	4.85	0.171	0.191
C	0.254	0.508	0.010	0.020
L	14.53	15.04	0.572	0.592
e	1.143	1.397	0.045	0.055
G	3.683	4.191	0.145	0.165
D	4.29	4.80	0.169	0.189
D1	4.34	4.85	0.171	0.191

## Taping Specification

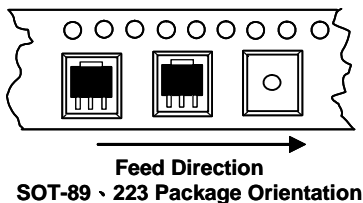

PACKAGE	Q'TY/BY REEL	Q'TY/BY BAG
SOT-89	1,000 ea	----
SOT-223	2,500 ea	----
TO-92	----	2,000 ea
μTO-92	----	2,000 ea

GMT Inc. does not assume any responsibility for use of any circuitry described, no circuit patent licenses are implied and GMT Inc. reserves the right at any time without notice to change said circuitry and specifications.