

Contents

Overview	2-3
RDM D-Subminiature Connectors	
RDM 31 Series Contacts • Specifications & Interface Dimensions.....	4
RDM 31 Series Contacts.....	5-8
RDM Standard Series Contacts • Specifications & Interface Dimensions.....	9
RDM Standard Series Contacts.....	10-14
RDM-HF Series Contacts • Specifications & Interface Dimensions	15
RDM-HF Series Contacts.....	16-19
RDM 75 Ohm Contacts • Specifications & Interface Dimensions.....	20
RDM 75 Ohm Contacts.....	21-24
RDM High Power Contacts • Specifications & Interface Dimensions.....	25
RDM High Power Contacts.....	26-27
RDM High Voltage Contacts.....	28
RDM 40 Series For DIN Style Housings • Specifications & Interface Dimensions.....	29
RDM 40 Series For DIN Style Housings.....	30-32
D-Subminiature Housings	
D-Subminiature Ordering Guide.....	33
D-Subminiature Selection Guide.....	34-35
D-Subminiature PCB Signal Contact Selection / Mounting Options	36
D-Subminiature Guide Pin Plates.....	37
D-Subminiature Shell Dimensions.....	38
D-Subminiature Edge Mount Connectors / PC Board Footprints.....	39
D-Subminiature Right Angle Mounting Dimensions.....	40
D-Subminiature Printed Circuit Board Footprint.....	41-76
Cable Reference Table.....	77
Mounting Hole Layouts.....	78
Cable Assembly Procedures.....	79-88
Tools	89-90
Other Product Offerings.....	91-92

While the information in this publication is believed to be accurate and reliable, all data presented is subject to change without notice. Winchester/Retconn disclaims responsibility for any damages resulting from application or any incompleteness or inaccuracies in the information presented. Consult factory for specific information on the latest design specifications.

Winchester/Retconn

400 Park Road • Watertown, Connecticut 06795-5000 • Phone: (860) 945-5000 • FAX: (860) 945-3950 • Internet: <http://www.litton-wed.com>

DS/1

OVERVIEW • RDM Product Line

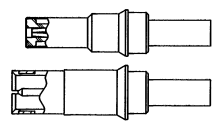
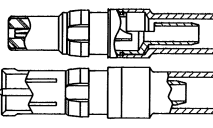
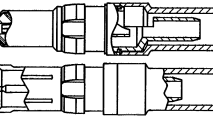
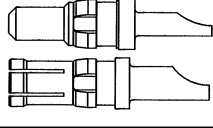
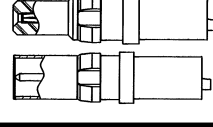
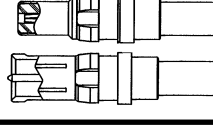
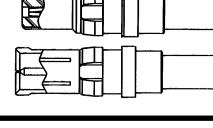
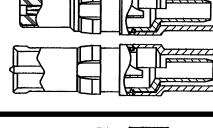
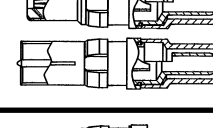
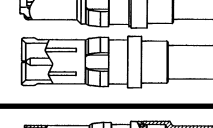
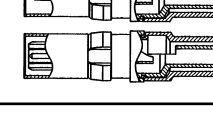
SERIES	DESCRIPTION	CENTER CONTACT	OUTER BODY	TYPICAL VIEW
14	75 Ohm crimp similar to the 24 Series. Specifically designed for an AMP housing.	Plug: Female Socket Receptacle: .040 Dia. Male Pin	Plug: Male Receptacle: Female	
20	Standard Series; solder / crimp and solder / solder types. Rated to 900 MHz.	Plug: Female Socket Receptacle: .040 Dia. Male Pin.	Plug: Male Receptacle: Female	
21	Similar to the 20 Series, thru 50 Ohm. Popular with cellular manufacturers. Rated to 2 GHz.	Plug: Female Socket Receptacle: .030 Dia. Male pin	Plug: Male Receptacle: Female	
22	High Power Contacts solder, crimp, and P.C. pin type.	NONE NONE	Plug: Male Receptacle: Female	
23	High Voltage Contacts, teflon bodies.	Plug: Female Socket Receptacle: .040 Dia. Male Pin	Plug: Male Receptacle: Female	
24	75 Ohm crimp / crimp popular with computer work station manufacturers.	Plug: Female Socket Receptacle: .040 Dia. Male Pin	Plug: Male Receptacle: Female	
26	Standard series, crimp / crimp for flexible cable, solder / solder for semi-rigid cable. Rated to 1500 MHz.	Plug: Female Socket Receptacle: .040 Dia. Male Pin	Plug: Male Receptacle: Female	
27	Similar to the 20 Series, except 75 Ohm impedance. Popular with CATV / Video applications.	Plug: Female Socket Receptacle: .040 Dia. Male Pin	Plug: Male Receptacle: Female	
28	Similar to the 20 Series, except, fits into a DIN Housing. DIN 41612.	Plug: Female Socket Receptacle: .040 Dia. Male Pin	Plug: Male Receptacle: Female	
29	Thru-50 crimp / crimp (cellular mfr.) crimp / crimp for flexible cable solder / solder, for semi-rigid cables.	Plug: Female Socket Receptacle: .030 Dia. Male Pin	Plug: Male Receptacle: Female	
30	DIN Coax Contacts for DIN Housings. 50 Ohm meet DIN Specifications.	Plug: Female Socket Receptacle: .020 Dia. Male Pin	Plug: Male Receptacle: Female	

Winchester/Retconn

OVERVIEW • RDM Product Line

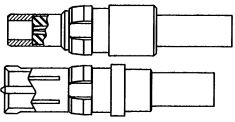
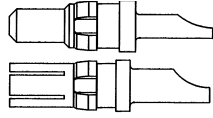
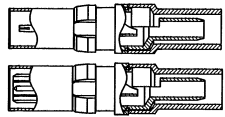
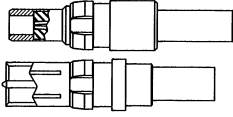
SERIES	DESCRIPTION	CENTER CONTACT	OUTER BODY	TYPICAL VIEW
31	Blind Mate Contact, fits in standard housing. Rated to 5 GHz. Mates with PkZ.	Plug: Female Socket Receptacle: .040 Dia. Male Pin	Plug: Male Receptacle: Female	
32	High Power Contacts, solder and crimp types for DIN housings. Similar to 22 Series.	NONE NONE	Plug: Male Receptacle: Female	
37	Similar to 30 Series, except 75 Ohms.	Plug: Female socket Receptacle: .015 Dia. Male Pin	Plug: Male Receptacle: Female	
40	Similar to 31 Series fits in DIN housing.	Plug: Female Socket Receptacle: .040 Dia. Male Pin	Plug: Male Receptacle: Female	

31 SERIES: Specifications & Interface Dimensions

MECHANICAL:

Materials:

Bodies, Plugs: Brass per ASTM B16, 1/2 HD
Bodies, Receptacles: Beryllium Copper per ASTM B196
Female Contacts: Beryllium Copper per ASTM B196
Male Contacts: Brass per ASTM B16, 1/2 HD
Insulators: Teflon per ASTM D1710
Crimp Ferrule: Annealed Copper Alloy
Clip Ring: Beryllium Copper per ASTM B194

Finish:

Body: Gold Plated per MIL-G-45204
Center Contact: Gold Plated per MIL-G-45204
Clip Ring: Nickel Plated per QQ-N-290

MATING CHARACTERISTICS:

Receptacles, Outer Contact:

3 lbs. Maximum Insertion on a $.1530 +.0001/-.0000$ Dia. Pin and a 4 oz. Minimum Withdrawl on a $.1500 +.0000/-.0001$ Dia. Pin

Plugs, Center Contact:

16 oz. Maximum Insertion on a $.0410 +.0001/-.0000$ Dia. Pin and a .5 oz. Minimum Withdrawl on a $.0390 +.0000/-.0001$ Dia. Pin

Retention in Shell: 15 lbs. Minimum

ELECTRICAL:

Impedance: 50 Ohms Nominal
Frequency Range: 0 to 5.0 GHz
Insulation Resistance: 5000 Megaohms Minimum
Contact Resistance: (Milliohms maximum)
Center Contact: 5.0
Outer Contact: 3.0
Voltage Standing Wave Ratio: 0 to 5.0 GHz
Straight Connector: $1.15 +.02F$ GHz on RG-316 Cable
Straight Connector: $1.15 +.01F$ GHz on .141 Dia. Semi-Rigid Cable

ENVIRONMENTAL:

Operating Temperature: -55°C to $+125^{\circ}\text{C}$
Vibration: MIL-STD-202, Method 204, Test Condition D
Shock: MIL-STD-202, Method 213, Test Condition I
Corrosion Resistance: MIL-STD-202, Method 101, Condition B

GENERAL INFORMATION:

31 Series Coaxial Contacts fit all D-Subminiature Connectors and are interchangeable with other manufacturer's product. Available in crimp or solder cable terminations.

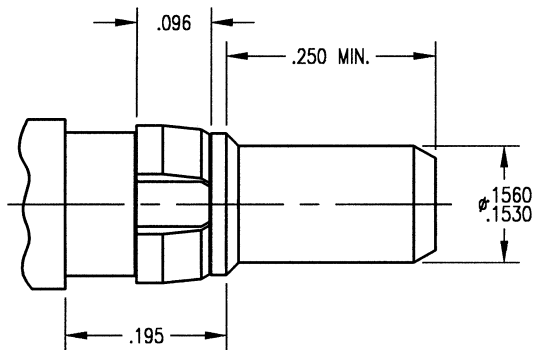

Plug Interface

Receptacle Interface

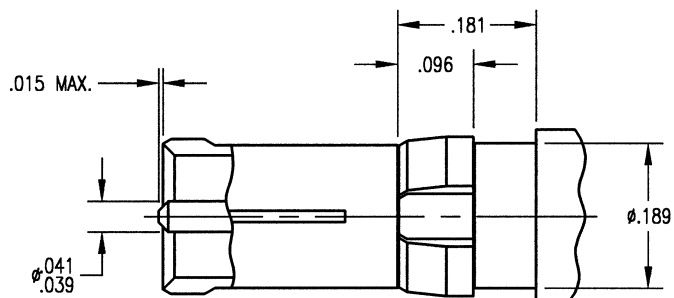

RDM 31 SERIES: Printed Circuit Board Contacts

Straight Plug

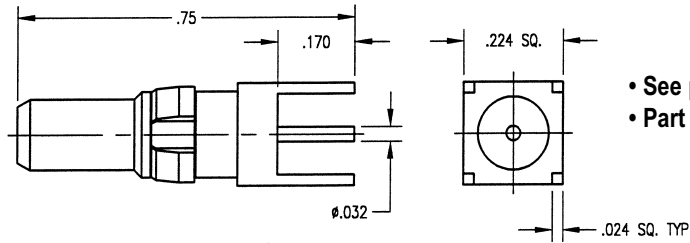

Part Number	Mounting Hole
310-010-6040G	N0. 060A

- See page 78 for mounting hole layout.
- Part number shown is for standard gold plating.

Straight Receptacle

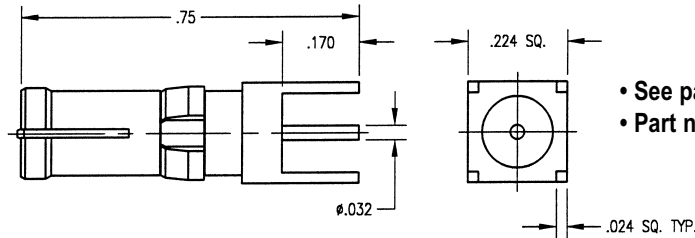

Part Number	Mounting Hole
311-010-6040G	N0. 060A

- See page 78 for mounting hole layout.
- Part number shown is for standard gold plating.

Right Angle Plug

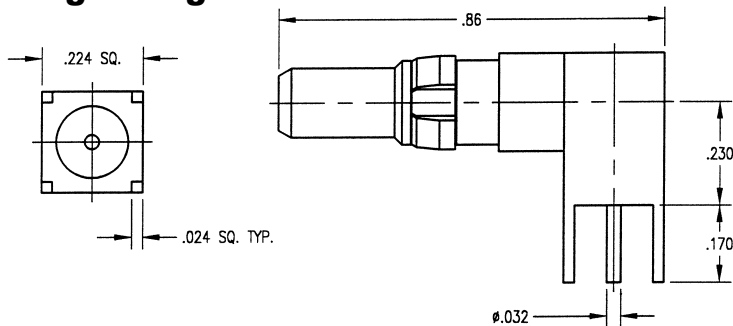

Part Number	Mounting Hole
312-010-6040G	N0. 060A

- See page 78 for mounting hole layout.
- Part number shown is for standard gold plating.

Right Angle Receptacle

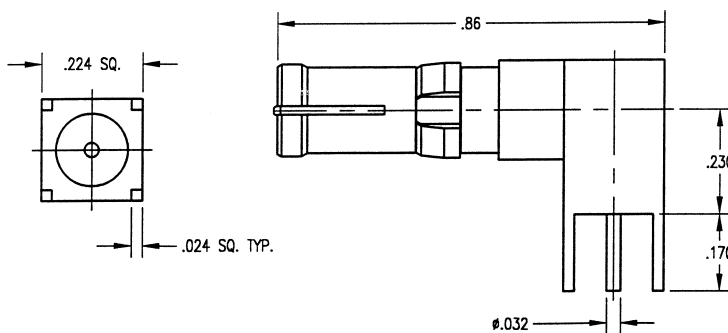

Part Number	Mounting Hole
313-010-6040G	N0. 060A

- See page 78 for mounting hole layout.
- Part number shown is for standard gold plating.

Straight Plug

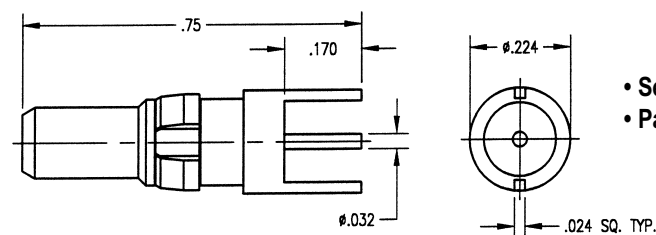

Part Number	Mounting Hole
310-010-6140G	N0. 061

- See page 78 for mounting hole layout.
- Part number shown is for standard gold plating.

Dimensions shown are in inches.

Winchester/Retconn

400 Park Road • Watertown, Connecticut 06795-5000 • Phone: (860) 945-5000 • FAX: (860) 945-3950 • Internet: <http://www.litton-wed.com>

RDM 31 SERIES: Printed Circuit Board Contacts

Straight Receptacle

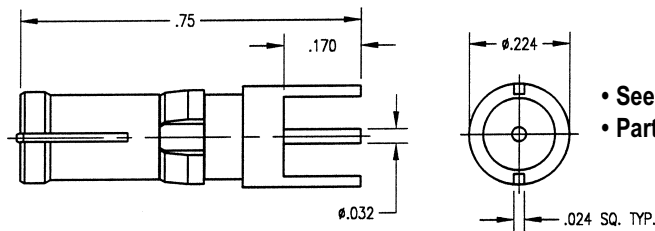

Part Number	Mounting Hole
311-010-6140G	N0. 061

- See page 78 for mounting hole layout.
- Part number shown is for standard gold plating.

Right Angle Plug

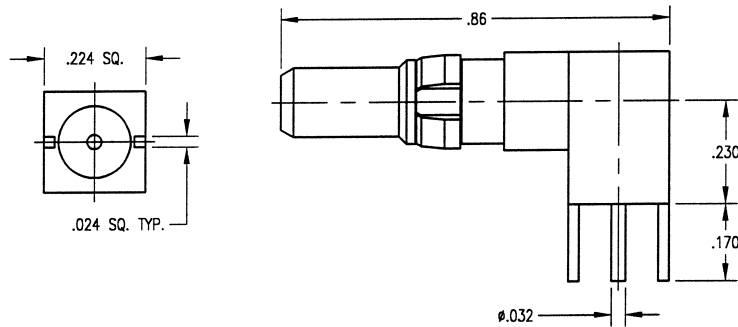

Part Number	Mounting Hole
312-010-6140G	N0. 061

- See page 78 for mounting hole layout.
- Part number shown is for standard gold plating.

Right Angle Receptacle

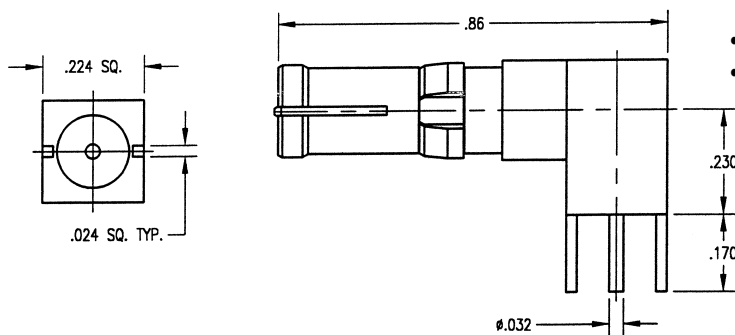

Part Number	Mounting Hole
313-010-6140G	N0. 061

- See page 78 for mounting hole layout.
- Part number shown is for standard gold plating.

RDM 31 SERIES: Crimp / Crimp, Flexible Cable

Straight Plug

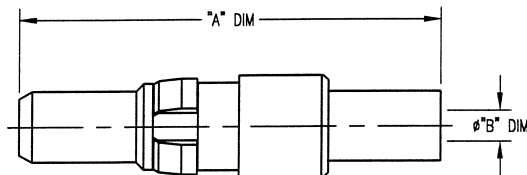

Part Number	Cable	"A" DIM	"B" DIM
310-910-0630G	RG- 316, 188	.93	.067
310-910-0631G	RG- 316 DS	.93	.067
310-910-1160G	RG- 141, 58	1.09	.120
310-910-1161G	RG- 142, 223	1.09	.120

- See page 87 for cable assembly procedures: CAP 9-07
- Part number shown is for standard gold plating.

Dimensions shown are in inches.

RDM 31 SERIES: Crimp / Crimp, Flexible Cable

Straight Receptacle

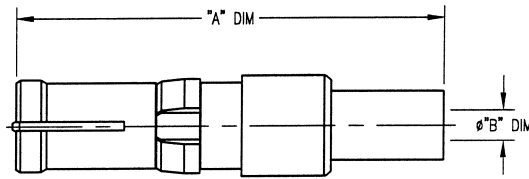

Part Number	Cable	"A" DIM	"B" DIM
311-910-0630G	RG- 316, 188	.89	.067
311-910-0631G	RG- 316 DS	.89	.067
311-910-1160G	RG- 141, 58	1.05	.120
311-910-1161G	RG- 142, 223	1.05	.120

- See page 87 for cable assembly procedures: CAP 9-07
- Part number shown is for standard gold plating.

Right Angle Plug

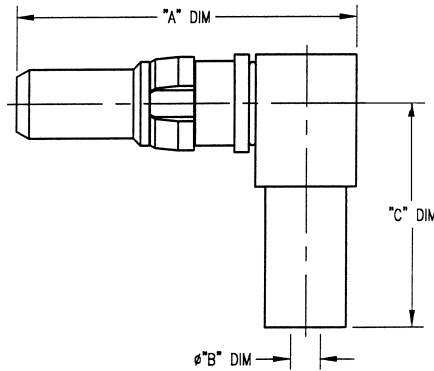

Part Number	Cable	"A" DIM	"B" DIM	"C" DIM
312-910-0630G	RG- 316, 188	.75	.067	.50
312-910-0631G	RG- 316 DS	.75	.067	.50
312-910-1160G	RG- 141, 58	.75	.120	.60
312-910-1161G	RG- 142, 223	.75	.120	.60

- See page 88 for cable assembly procedures: CAP 9-16
- Part number shown is for standard gold plating.

Right Angle Receptacle

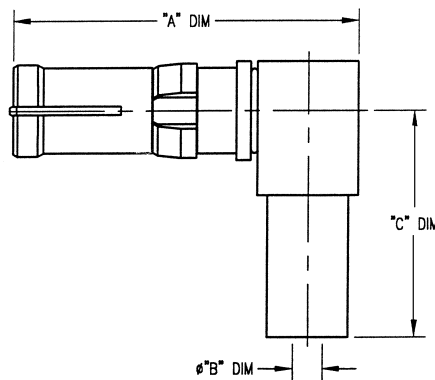

Part Number	Cable	"A" DIM	"B" DIM	"C" DIM
313-910-0630G	RG- 316, 188	.77	.067	.50
313-910-0631G	RG- 316 DS	.77	.067	.50
313-910-1160G	RG- 141, 58	.77	.120	.60
313-910-1161G	RG-142, 223	.77	.120	.60

- See page 88 for cable assembly procedures: CAP 9-16
- Part number shown is for standard gold plating.

RDM 31 SERIES: Solder / Solder, Semi-Rigid Cable

Straight Plug

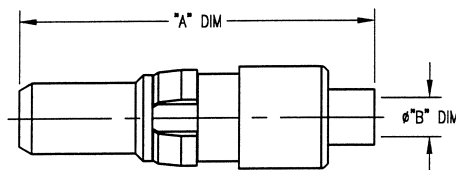

Part Number	Cable	"A" DIM	"B" DIM
310-510-0850G	RG- 405 (.085 SR)	.79	.090
310-510-1410G	RG- 402 (.141 SR)	.79	.148

- See page 83 for cable assembly procedures: CAP 5-15
- Part number shown is for standard gold plating.

Straight Receptacle

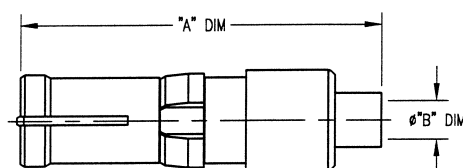

Part Number	Cable	"A" DIM	"B" DIM
311-510-0850G	RG- 405 (.085 SR)	.75	.090
311-510-1410G	RG- 402 (.141 SR)	.75	.148

- See page 83 for cable assembly procedures: CAP 5-15
- Part number shown is for standard gold plating.

Dimensions shown are in inches.

RDM 31 SERIES: Solder / Solder, Semi-Rigid Cable

Right Angle Plug

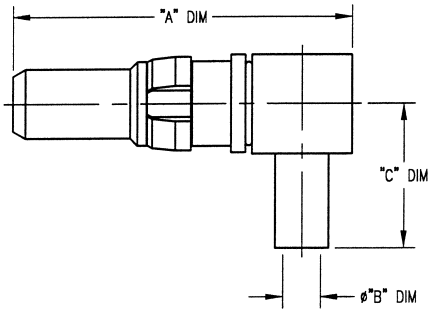

Part Number	Cable	"A" DIM	"B" DIM	"C" DIM
312-510-0850G	RG- 405 (.085 SR)	.75	.090	.31
312-510-1410G	RG- 402 (.141 SR)	.75	.148	.31

- See page 84 for cable assembly procedure: CAP 5-16
- Part number shown is for standard gold plating.

Right Angle Receptacle

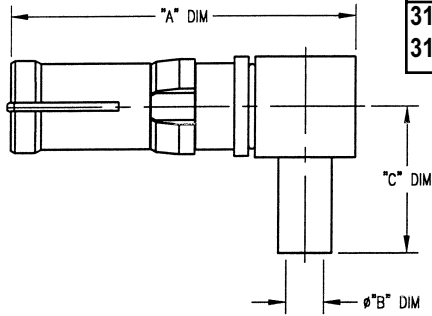

Part Number	Cable	"A" DIM	"B" DIM	"C" DIM
313-510-0850G	RG- 405 (.085 SR)	.77	.090	.31
313-510-1410G	RG- 402 (.141 SR)	.77	.148	.31

- See page 84 for cable assembly procedures: CAP 5-16
- Part number shown is for standard gold plating.

Dimensions shown are in inches.

RDM: Specifications & Interface Dimensions

MECHANICAL:

Materials:

Bodies, Plugs: Brass per ASTM B16, 1/2 HD
Bodies, Receptacles: Beryllium Copper per ASTM B196
Female Contacts: Beryllium Copper per ASTM B196
Male Contacts: Brass per ASTM B16, 1/2 HD
Insulators: Teflon per ASTM D1710
Crimp Ferrule: Annealed Copper Alloy
Clip Ring: Phosphor Bronze per ASTM B103

Finish:

Body: Gold Plated per MIL-G-45204
Center Contact: Gold Plated per MIL-G-45204
Clip Ring: Nickel Plated per QQ-N-290

MATING CHARACTERISTICS:

Receptacles, Outer Contact:

3 lbs. Maximum Insertion on a $.1530 + .0001 / - .0000$ Dia. Pin
and a 4 oz. Minimum Withdrawl on a $.1500 + .0000 / - .0001$
Dia. Pin

Plugs, Center Contact: 16 oz. Maximum Insertion on a $.0410 + .0001 / - .0000$ Dia. Pin
and .5 oz. Minimum Withdrawl on a $.0390 + .0000 / - .0001$ Dia. Pin

Retention in Shell:

Plugs and Receptacles: 15 lbs. Minimum

ELECTRICAL:

Impedance: 50 Ohms Nominal
Frequency Range: 0 to 900 MHz
Insulation Resistance: 1000 Megaohms Minimum
Contact Resistance: (Milliohms Maximum)
Center Contact: 5.0
Outer Contact: 3.0

ENVIRONMENTAL:

Operating Temperature: -55°C to +125°C
Vibration: MIL-STD-202, Method 204, Test Condition D
Shock: MIL-STD-202, Method 213, Test Condition I
Corrosion Resistance: MIL-STD-202, Method 101, Condition B

GENERAL INFORMATION:

RDM Coaxial Contacts fit all D-Subminiature Connectors and are available in crimp or solder cable terminations.

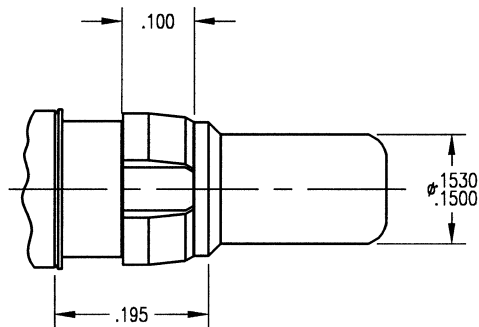

Plug Interface

Receptacle Interface

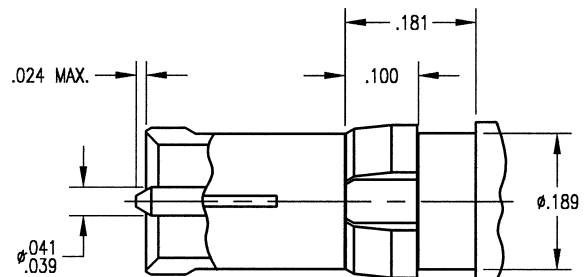

Dimensions shown are in inches.

Winchester/Retconn

RDM: Solder / Solder, Semi-Rigid Cable

Straight Receptacle

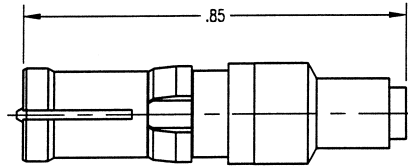

Part Number	Cable
201-510-0470G	.047 SR
201-510-0850G	.085 SR
201-510-1410G	.141 SR

- See page 81 for cable assembly procedures: CAP 5-09
- Part number shown is for standard gold plating.
- For military finish change suffix to "H".
- For commercial finish change suffix to "C".

Straight Plug

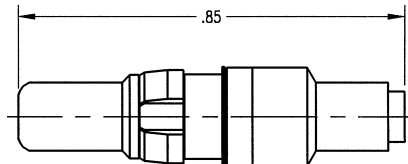

Part Number	Cable
200-510-0470G	.047 SR
200-510-0850G	.085 SR
200-510-1410G	.141 SR

- See page 81 for cable assembly procedures: CAP 5-09
- Part number shown is for standard gold plating.
- For military finish change suffix to "H".
- For commercial finish change suffix to "C".

Right Angle Receptacle

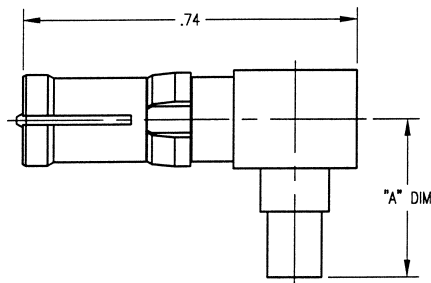

Part Number	Cable	"A" DIM
203-510-0470G	.047 SR	.29
203-510-0850G	.085 SR	.35
203-510-1410G	.141 SR	.35

- See page 82 for cable assembly procedures: CAP 5-10
- Part number shown is for standard gold plating.
- For military finish change suffix to "H".
- For commercial finish change suffix to "C".

Right Angle Plug

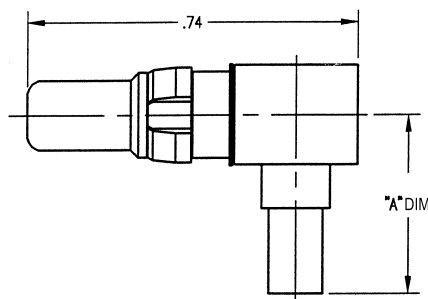

Part Number	Cable	"A" DIM
202-510-0470G	.047 SR	.29
202-510-0850G	.085 SR	.35
202-510-1410G	.141 SR	.35

- See page 82 for cable assembly procedures: CAP 5-10
- Part number shown is for standard gold plating.
- For military finish change suffix to "H".
- For commercial finish change suffix to "C".

RDM: Solder / Solder, Flexible Cable

Straight Receptacle

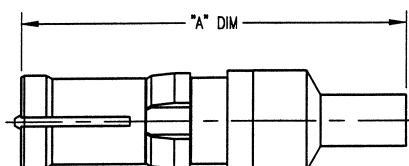

Part Number	Cable	"A" DIM
201-510-0360G	RG- 178, 196	.93
201-510-0630G	RG- 316, 188	.93
201-510-1070G	RG- 180, 195	1.03
201-510-1160G	RG- 141, 58	1.03
201-510-1161G	RG- 142, 223	1.03

- See page 79 for cable assembly procedures: CAP 5-07
- Part number shown is for standard gold plating.
- For military finish change suffix to "H".
- For commercial finish change suffix to "C".

Dimensions shown are in inches.

Winchester/Retconn

RDM: Solder / Solder, Flexible Cable

Straight Plug

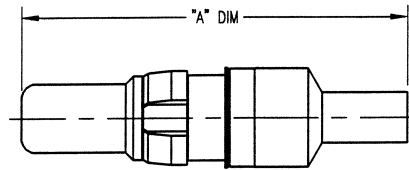

Part Number	Cable	"A" DIM
200-510-0360G	RG- 178, 196	.93
200-510-0630G	RG- 316, 188	.93
200-510-1070G	RG- 180, 195	1.03
200-510-1160G	RG- 141, 58	1.03
200-510-1161G	RG- 142, 223	1.03

- See page 79 for cable assembly procedures: CAP 5-07
- Part number shown is for standard gold plating.
- For military finish change suffix to "H".
- For commercial finish change suffix to "C".

Right Angle Receptacle

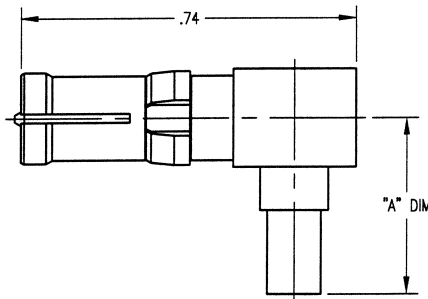

Part Number	Cable	"A" DIM
203-510-0360G	RG- 178, 196	.49
203-510-0630G	RG- 316, 188	.49
203-510-1070G	RG- 180, 195	.49
203-510-1160G	RG- 141, 58	.49
203-510-1161G	RG- 142, 223	.49

- See page 80 for cable assembly procedures: CAP 5-08
- Part number shown is for standard gold plating.
- For military finish change suffix to "H".
- For commercial finish change suffix to "C".

Right Angle Plug

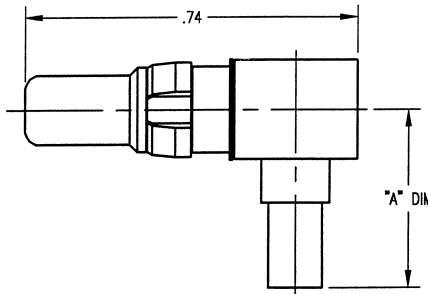

Part Number	Cable	"A" DIM
202-510-0360G	RG- 178, 196	.49
202-510-0630G	RG- 316, 188	.49
202-510-1070G	RG- 180, 195	.60
202-510-1160G	RG- 141, 58	.60
202-510-1161G	RG- 142, 223	.60

- See page 80 for cable assembly procedures: CAP 5-08
- Part number shown is for standard gold plating.
- For military finish change suffix to "H".
- For commercial finish change suffix to "C".

RDM: Solder / Crimp, Flexible Cable

Straight Receptacle

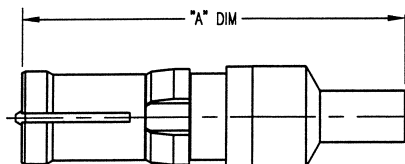

Part Number	Cable	"A" DIM
201-910-0360G	RG- 178, 196	.93
201-910-0630G	RG- 316, 188	.93
201-910-1070G	RG- 180, 195	1.03
201-910-1160G	RG- 141, 58	1.03
201-910-1161G	RG- 142, 223	1.03

- See page 85 for cable assembly procedures: CAP 9-01
- Part number shown is for standard gold plating.
- For military finish change suffix to "H".
- For commercial finish change suffix to "C".

Dimensions shown are in inches.

RDM: Solder / Crimp, Flexible Cable

Straight Plug

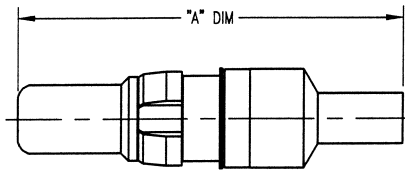

Part Number	Cable	"A" DIM
200-910-0360G	RG- 178, 196	.93
200-910-0630G	RG- 316, 188	.93
200-910-1070G	RG- 180, 195	1.03
200-910-1160G	RG- 141, 58	1.03
200-910-1161G	RG- 142, 223	1.03

- See page 85 for cable assembly procedures: CAP 9-01
- Part number shown is for standard gold plating.
- For military finish change suffix to "H".
- For commercial finish change suffix to "C".

Right Angle Receptacle

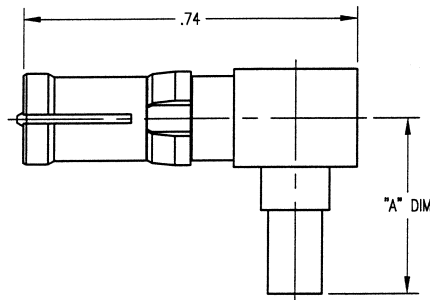

Part Number	Cable	"A" DIM
203-910-0360G	RG- 178, 196	.49
203-910-0630G	RG- 316, 188	.49
203-910-1070G	RG- 180, 195	.60
203-910-1160G	RG- 141, 58	.60
203-910-1161G	RG- 142, 223	.60

- See page 86 for cable assembly procedures: CAP 9-02
- Part number shown is for standard gold plating.
- For military finish change suffix to "H".
- For commercial finish change suffix to "C".

Right Angle Plug

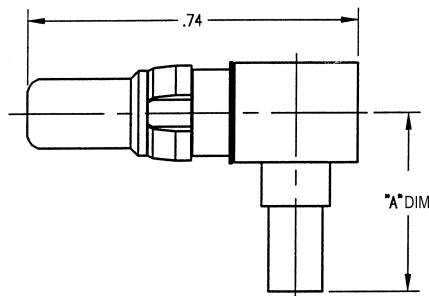

Part Number	Cable	"A" DIM
202-910-0360G	RG- 178, 196	.49
202-910-0630G	RG- 316, 188	.49
202-910-1070G	RG- 180, 195	.60
202-910-1160G	RG- 141, 58	.60
202-910-1161G	RG- 142, 223	.60

- See page 86 for cable assembly procedures: CAP 9-02
- Part number shown is for standard gold plating.
- For military finish change suffix to "H".
- For commercial finish change suffix to "C".

RDM: Crimp / Crimp, Flexible Cable

Straight Receptacle

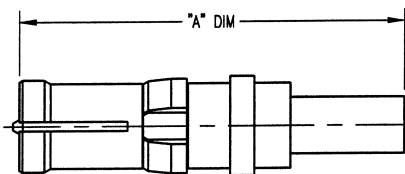

Part Number	Cable	"A" DIM
261-910-0630G	RG- 316, 188	.84
261-910-1070G	RG- 180, 195	1.00
261-910-1160G	RG- 141, 58	1.00
261-910-1161G	RG- 142, 223	1.00

- See page 87 for cable assembly procedures: CAP 9-07
- Part number shown is for standard gold plating.
- For military finish change suffix to "H".
- For commercial finish change suffix to "C".

Straight Plug

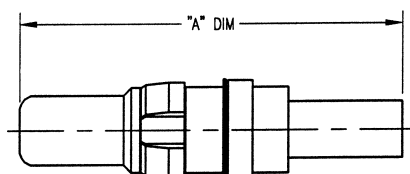

Part Number	Cable	"A" DIM
260-910-0630G	RG- 316, 188	.86
260-910-1070G	RG- 180, 195	1.01
260-910-1160G	RG- 141, 58	1.01
260-910-1161G	RG- 142, 223	1.01

- See page 87 for cable assembly procedures: CAP 9-07
- Part number shown is for standard gold plating.
- For military finish change suffix to "H".
- For commercial finish change suffix to "C".

Dimensions shown are in inches.

Winchester/Retconn

RDM: Printed Circuit Board Contacts

Straight Receptacle

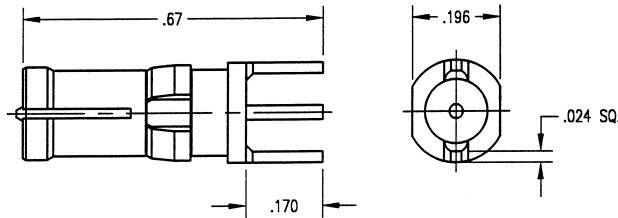

Part Number	Mounting Hole
201-010-6140G	NO. 061

- See page 78 for mounting hole layout.
- Part number shown is for standard gold plating.
- For military finish change suffix to "H".
- For commercial finish change suffix to "C".

Straight Plug

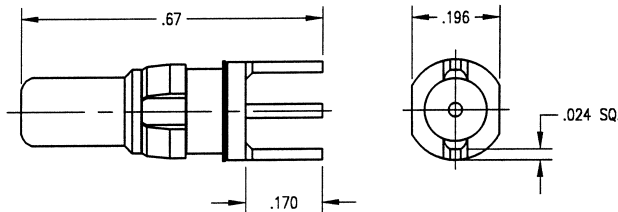

Part Number	Mounting Hole
200-010-6140G	NO. 061

- See page 78 for mounting hole layout.
- Part number shown is for standard gold plating.
- For military finish change suffix to "H".
- For commercial finish change suffix to "C".

Right Angle Receptacle

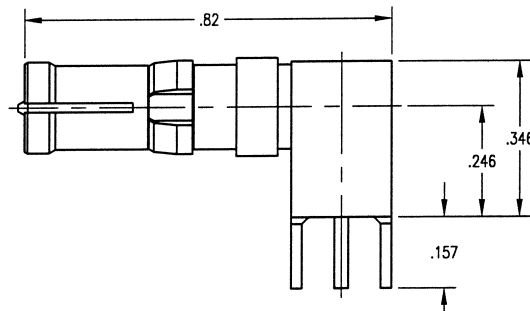

Part Number	Mounting Hole
203-010-6140G	NO. 061

- See page 78 for mounting hole layout.
- Part number shown is for standard gold plating.
- For military finish change suffix to "H".
- For commercial finish change suffix to "C".

Right Angle Plug

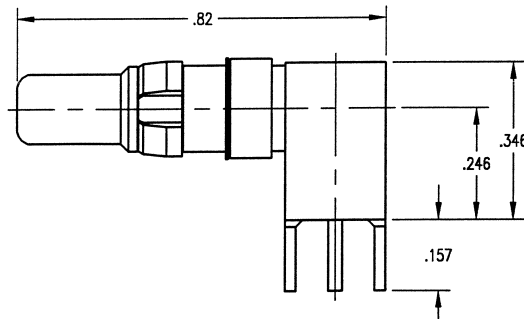

Part Number	Mounting Hole
202-010-6140G	NO. 061

- See page 78 for mounting hole layout.
- Part number shown is for standard gold plating.
- For military finish change suffix to "H".
- For commercial finish change suffix to "C".

RDM: Same - Series Adapters

Receptacle / Receptacle

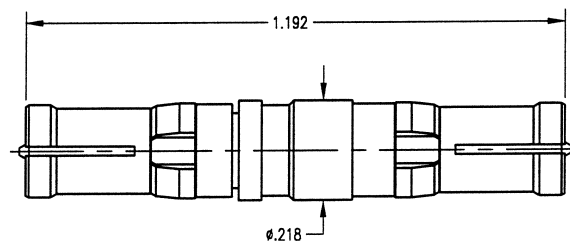

Part Number
201-201-0000G

- Part number shown is for standard gold plating.
- For military finish change suffix to "H".
- For commercial finish change suffix to "C".

Dimensions shown are in inches.

RDM: Same - Series Adapters

Plug / Plug

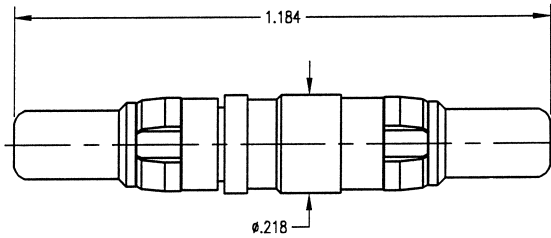

Part Number
200-200-0000G

- Part number shown is for standard gold plating.
- For military finish change suffix to "H".
- For commercial finish change suffix to "C".

Plug / Receptacle

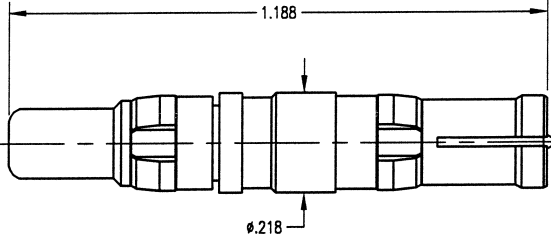

Part Number
200-201-0000G

- Part number shown is for standard gold plating.
- For military finish change suffix to "H".
- For commercial finish change suffix to "C".

RDM: Between Series Adapters

RDM Plug / SMA Plug

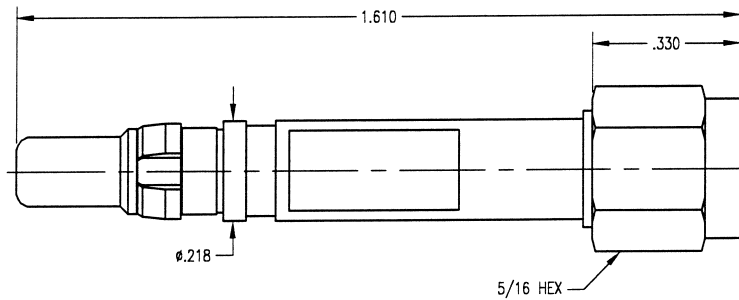

Part Number
200-350-0000H

- Part number shown is for gold plating.
- For nickel plate change suffix to "N"

RDM Receptacle SMA Jack

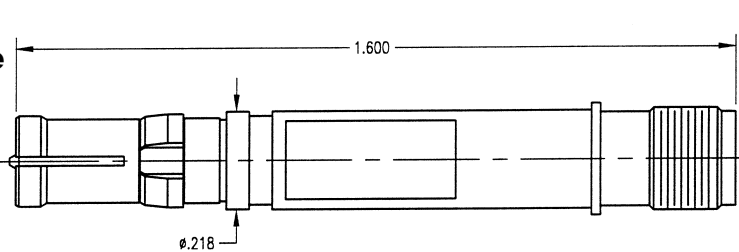

Part Number
201-351-0000H

- Part number shown is for gold plating.
- For nickel plate change suffix to "N"

RDM Receptacle SMA Plug

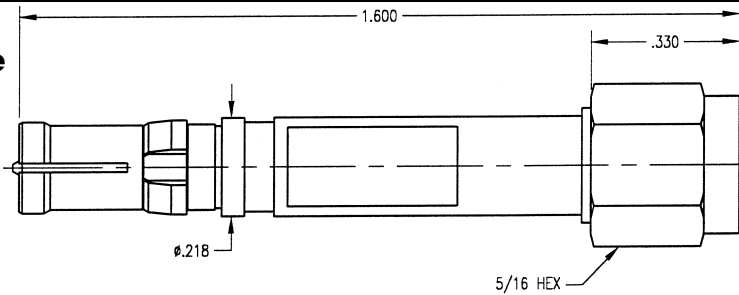

Part Number
201-350-0000H

- Part number shown is for gold plating.
- For nickel plate change suffix to "N"

RDM Plug / SMA Jack

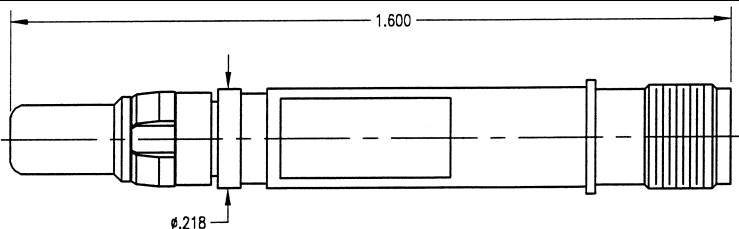

Part Number
200-351-0000H

- Part number shown is for gold plating.
- For nickel plate change suffix to "N"

Dimensions shown are in inches.

Winchester/Retconn

RDM - HF: Specifications & Interface Dimensions

MECHANICAL:

Materials:

- Bodies, Plugs: Brass per ASTM B16, 1/2 HD
- Bodies, Receptacles: Beryllium Copper per ASTM B196

Female Contacts: Beryllium Copper per ASTM B196

Male Contacts: Brass per ASTM B16, 1/2 HD

Insulators: Teflon per ASTM D1710

Crimp Ferrule: Annealed Copper Alloy

Clip Ring: Phosphor Bronze per ASTM B103

Finish:

- Body: Gold Plated per MIL-G-4504
- Center Contact: Gold Plated per MIL-G-45204
- Clip Ring: Nickel Plated per QQ-N-290

MATING CHARACTERISTICS

Receptacles, Outer Contact:

3 lbs. Maximum Insertion on a $.1530 +.0001 / -.0000$ Dia. Pin and a 4 oz. Minimum Withdrawl on a $.1500 + .0000 / .0001$ Dia. Pin

Plugs, Center Contact:

16oz. Maximum Insertion on a $.0410 + .0001 / -.0000$ Dia. Pin and a 5 oz. Minimum Withdrawl on a $.0390 + .0000 / -.0001$ Dia. Pin

Retention in Shell: 15 lbs. Minimum

ELECTRICAL:

Impedance: 50 Ohms Nominal

Frequency Range: 0 to 1500 MHz

Insulation Resistance: 1000 Megaohms Minimum

Contact Resistance: (Milliohms Maximum)

Center Contact: 5.0

Outer Contact: 3.0

Dielectric Withstanding Voltage (DWV):

Straight: 1000 VRMS

Right Angle: 800 VRMS

Voltage Standing Wave Ratio:

1.15 Maximum from 0 to 1200 MHz

1.35 Maximum from 1200 to 1500 MHz

ENVIRONMENTAL:

Operating Temperature: -55°C to $+125^{\circ}\text{C}$

Vibration: MIL-STD-202, Method 204, Test Condition D

Shock: MIL-STD-202, Method 213, Test Condition I

Corrosion Resistance: MIL-STD-202, Method 101, Condition B

GENERAL INFORMATION:

RDM Coaxial Contacts fit all D-Subminiature Connectors and are interchangeable with other manufacturer's product. Available in crimp or solder cable terminations.

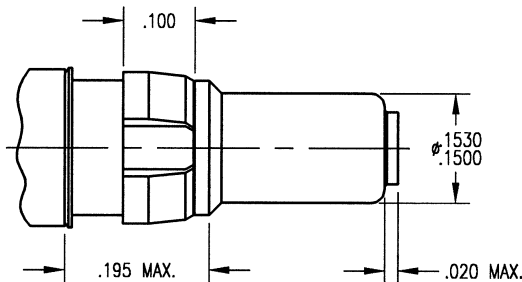

Plug Interface

Receptacle Interface

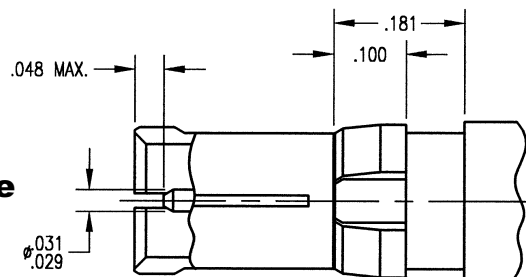

Dimensions shown are in inches.

Winchester/Retconn

RDM - HF: Solder / Solder, Semi-Rigid Cable

Straight Receptacle

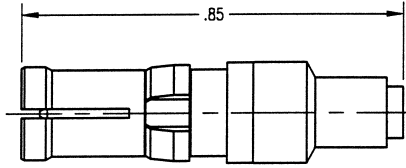

Part Number	Cable
211-510-0470G	.047 SR
211-510-0850G	.085 SR
211-510-1410G	.141 SR

- See page 81 for cable assembly procedures: CAP 5-09
- Part number shown is for standard gold plating.
- For military finish change suffix to "H"
- For commercial finish change suffix to "C"

Straight Plug

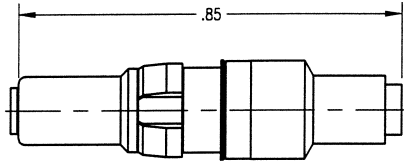

Part Number	Cable
210-510-0470G	.047 SR
210-510-0850G	.085 SR
210-510-1410G	.141 SR

- See page 81 for cable assembly procedures: CAP 5-09
- Part number shown is for standard gold plating.
- For military finish change suffix to "H"
- For commercial finish change suffix to "C"

Right Angle Receptacle

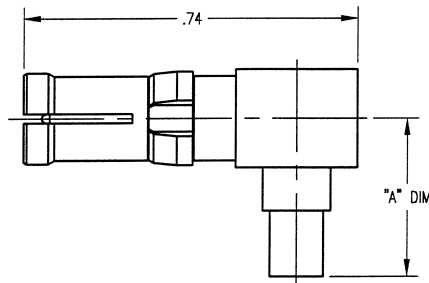

Part Number	Cable	"A" DIM
213-510-0470G	.047 SR	.29
213-510-0850G	.085 SR	.35
213-510-1410G	.141 SR	.35

- See page 82 for cable assembly procedures: CAP 5-10
- Part number shown is for standard gold plating.
- For military finish change suffix to "H"
- For commercial finish change suffix to "C"

Right Angle Plug

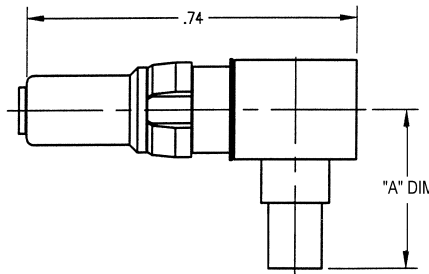

Part Number	Cable	"A" DIM
212-510-0470G	.047 SR	.29
212-510-0850G	.085 SR	.35
212-510-1410G	.141 SR	.35

- See page 82 for cable assembly procedures: CAP 5-10
- Part number shown is for standard gold plating.
- For military finish change suffix to "H"
- For commercial finish change suffix to "C"

RDM - HF: Solder / Crimp, Flexible Cable

Straight Receptacle

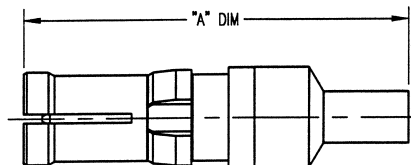

Part Number	Cable	"A" DIM
211-910-0360G	RG- 178, 196	.93
211-910-0630G	RG- 316, 188	.93
211-910-1070G	RG- 180, 195	1.03
211-910-1160G	RG- 141, 58	1.03
211-910-1161G	RG- 142, 223	1.03

- See page 85 for cable assembly procedures: CAP 9-01
- Part number shown is for standard gold plating.
- For military finish change suffix to "H"
- For commercial finish change suffix to "C"

Dimensions shown are in inches.

Winchester/Retconn

RDM - HF: Solder / Crimp, Flexible Cable

Straight Plug

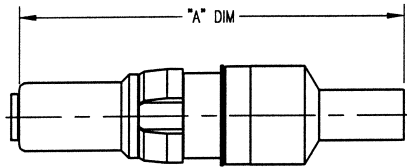

Part Number	Cable	"A" DIM
210-910-0360G	RG- 178, 196	.93
210-910-0630G	RG- 316, 188	.93
210-910-1070G	RG- 180, 195	1.03
210-910-1160G	RG- 141, 58	1.03
210-910-1161G	RG- 142, 223	1.03

- See page 85 for cable assembly procedures: CAP 9-01
- Part number shown is for standard gold plating.
- For military finish change suffix to "H"
- For commercial finish change suffix to "C"

Right Angle Receptacle

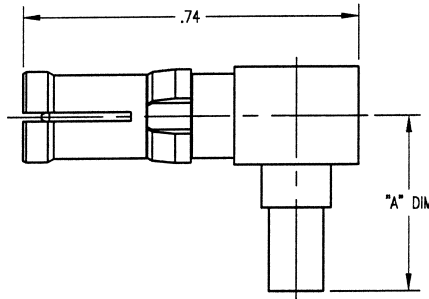

Part Number	Cable	"A" DIM
213-910-0360G	RG- 178, 196	.49
213-910-0630G	RG- 316, 188	.49
213-910-1070G	RG- 180, 195	.60
213-910-1160G	RG- 141, 58	.60
213-910-1161G	RG- 142, 223	.60

- See page 86 for cable assembly procedures: CAP 9-02
- Part number shown is for standard gold plating.
- For military finish change suffix to "H"
- For commercial finish change suffix to "C"

Right Angle Plug

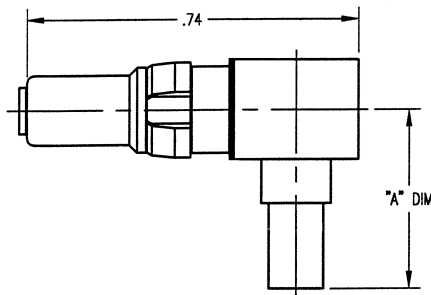

Part Number	Cable	"A" DIM
212-910-0360G	RG- 178, 196	.49
212-910-0630G	RG- 316, 188	.49
212-910-1070G	RG- 180, 195	.60
212-910-1160G	RG- 141, 58	.60
212-910-1161G	RG- 142, 223	.60

- See page 86 for cable assembly procedures: CAP 9-02
- Part number shown is for standard gold plating.
- For military finish change suffix to "H"
- For commercial finish change suffix to "C"

RDM - HF: Crimp / Crimp, Flexible Cable

Straight Receptacle

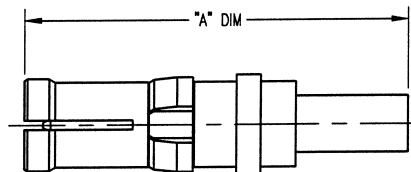

Part Number	Cable	"A" DIM
291-910-0630G	RG- 316, 188	.84
291-910-1070G	RG- 180, 195	1.00
291-910-1160G	RG- 141, 58	1.00
291-910-1161G	RG 142, 223	1.00

- See page 87 for cable assembly procedures: CAP 9-07
- Part number shown is for standard gold plating.
- For military finish change suffix to "H"
- For commercial finish change suffix to "C"

Dimensions shown are in inches.

RDM - HF: Crimp / Crimp, Flexible Cable

Straight Plug

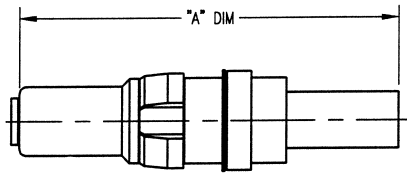

Part Number	Cable	"A" DIM
290-910-0630G	RG- 316, 188	.86
290-910-1070G	RG- 180, 195	1.01
290-910-1160G	RG- 141, 58	1.01
290-910-1161G	RG- 142, 223	1.01

- See page 87 for cable assembly procedures: CAP 9-07
- Part number shown is for standard gold plating.
- For military finish change suffix to "H"
- For commercial finish change suffix to "C"

RDM - HF: Printed Circuit Board Contacts

Straight Receptacle

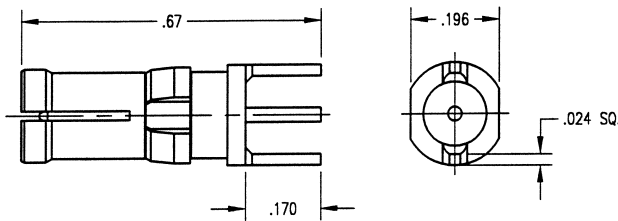

Part Number	Mounting Hole
211-010-6140G	N0. 061

- See page 78 for mounting hole layout.
- Part number shown is for standard gold plating.
- For military finish change suffix to "H"
- For commercial finish change suffix to "C"

Straight Plug

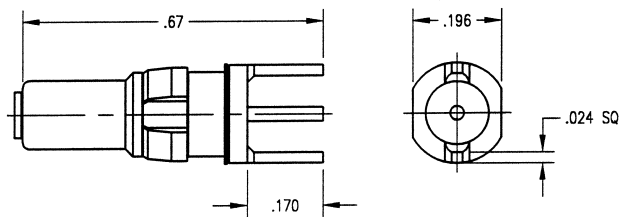

Part Number	Mounting Hole
210-010-6140G	N0. 061

- See page 78 for mounting hole layout.
- Part number shown is for standard gold plating.
- For military finish change suffix to "H"
- For commercial finish change suffix to "C"

Right Angle Receptacle

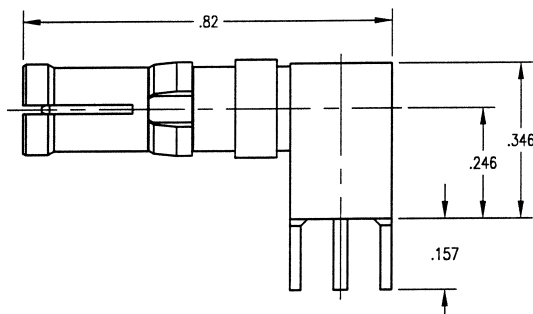

Part Number	Mounting Hole
213-010-6140G	N0. 061

- See page 78 for mounting hole layout.
- Part number shown is for standard gold plating.
- For military finish change suffix to "H"
- For commercial finish change suffix to "C"

Right Angle Plug

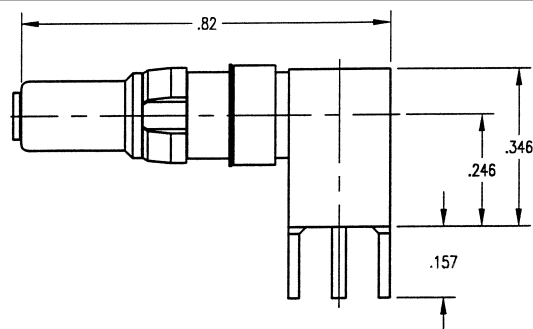

Part Number	Mounting Hole
212-010-6140G	N0. 061

- See page 78 for mounting hole layout.
- Part number shown is for standard gold plating.
- For military finish change suffix to "H"
- For commercial finish change suffix to "C"

Dimensions shown are in inches.

RDM - HF: Same - Series Adapters

Receptacle / Receptacle

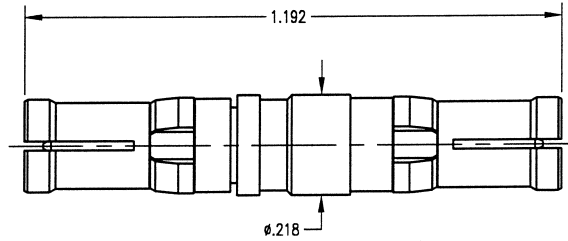

Part Number
211-211-0000G

- Part number shown is for standard gold plating.
- For military finish change suffix to "H"
- For commercial finish change suffix to "C"

Plug / Plug

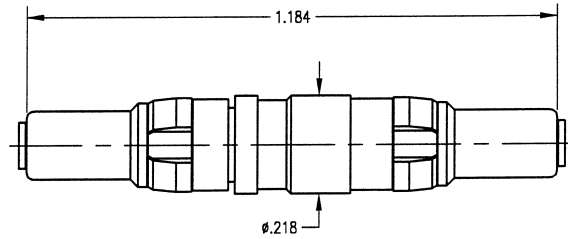

Part Number
210-210-0000G

- Part number shown is for standard gold plating.
- For military finish change suffix to "H"
- For commercial finish change suffix to "C"

Plug / Receptacle

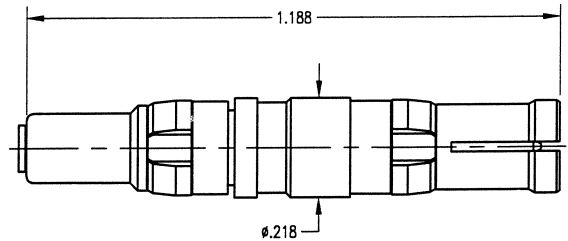

Part Number
210-211-0000G

- Part number shown is for standard gold plating.
- For military finish change suffix to "H"
- For commercial finish change suffix to "C"

Dimensions shown are in inches.

RDM 75 OHM: Specifications & Interface Dimensions

MECHANICAL:

Materials:

Bodies, Plugs: Brass per ASTM B16, 1/2 HD
Bodies Receptacles: Beryllium Copper per ASTM B196
Female Contacts: Beryllium Copper per ASTM B196
Male Contacts: Brass per ASTM B16, 1/2/ HD
Insulators: Teflon per ASTM D1710
Crimp Ferrule: Annealed Copper Alloy
Clip Ring: Phosphor Bronze per ASTM B103

Finish:

Body: Gold Plated per MIL-STD-45204
Center Contact: Gold Plated per MIL-STD-45204
Clip Ring: Nickel Plated per QQ-N-290

MATING CHARACTERISTICS:

Receptacles, Outer Contact: 3 lbs. Maximum Insertion on a .1530 +.0001 / -.0000 Dia. Pin and 4 oz. Minimum Withdrawl on a .1500 +.0000 / -.0001 Dia. Pin

Plugs, Center Contact: 16 oz. Maximum Insertion on a .0419 +.0001 / -.0000 Dia. Pin and 5 oz. Minimum Withdrawl on a .0390 +.0000 / -.0001 Dia. Pin

Retension in Shell: 15 lbs. Minimum

ELECTRICAL:

Impedance: 75 Ohm Nominal
Frequency Range: 0 - 2 GHz
Insulation Resistance: 1000 Megaohms Minimum
Contact Resistance: (Milliohms Maximum)
Center Contact: 5.0
Outer Contact: 3.0
Dielectric Withstanding Voltage (DWV):
Straight: 1000 VRMS
Right Angle: 800 VRMS
Voltage Standing Wave Ratio:
1.05 Maximum from 0 to 1000 MHz
1.25 Maximum from 1000 to 2000 MHz

ENVIRONMENTAL:

Operating Temperature: -55°C to +125°C
Vibration: MIL-STD-202, Method 204, Test Condition D
Shock: MIL-STD-202, Method 213, Test Condition I
Corrosion Resistance: MIL-STD-202, Method 101, Condition B

GENERAL INFORMATION:

RDM Coaxial Contacts fit all D-Subminiature Connectors and are interchangeable with other manufacturer's product. Available in crimp or solder cable versions.

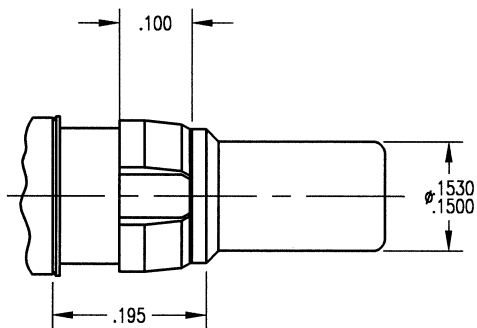

Plug Interface

Receptacle Interface

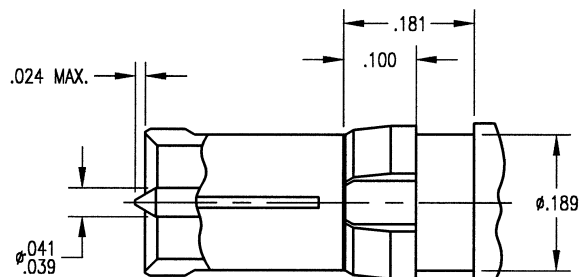

Dimensions shown are in inches.

Winchester/Retconn

RDM 75 OHM: Solder / Solder, Semi-Rigid Cable

Straight Receptacle

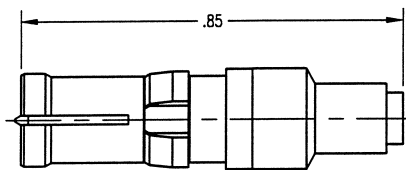

Part Number	Cable
271-510-0470G	.047 SR
271-510-0850G	.085 SR
271-510-1410G	.141 SR

- See page 81 for cable assembly procedures: CAP 5-09
- Part number shown is for standard gold plating.
- For military finish change suffix to "H"
- For commercial finish change suffix to "C"

Straight Plug

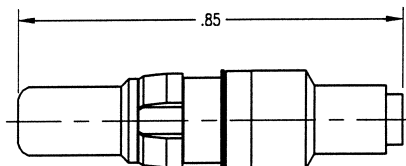

Part Number	Cable
270-510-0470G	.047 SR
270-510-0850G	.085 SR
270-510-1410G	.141 SR

- See page 81 for cable assembly procedures: CAP 5-09
- Part number shown is for standard gold plating.
- For military finish change suffix to "H"
- For commercial finish change suffix to "C"

Right Angle Receptacle

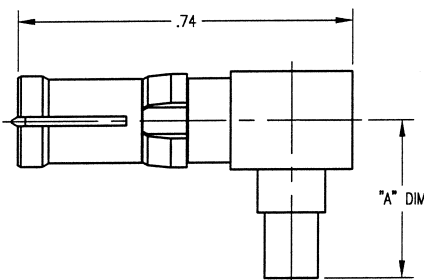

Part Number	Cable	"A" DIM
273-510-0470G	.047 SR	.29
273-510-0850G	.085 SR	.35
273-510-1410G	.141 SR	.35

- See page 82 for cable assembly procedures: CAP 5-10
- Part number shown is for standard gold plating.
- For military finish change suffix to "H"
- For commercial finish change suffix to "C"

Right Angle Plug

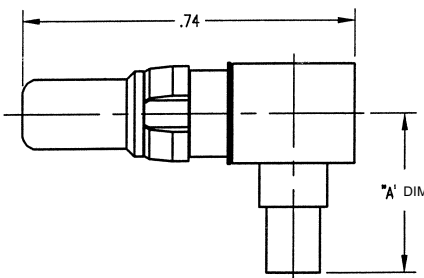

Part Number	Cable	"A" DIM
272-510-0470G	.047 SR	.29
272-510-0850G	.085 SR	.35
272-510-1410G	.141 SR	.35

- See page 82 for cable assembly procedures: CAP 5-10
- Part number shown is for standard gold plating.
- For military finish change suffix to "H"
- For commercial finish change suffix to "C"

RDM 75 OHM: Solder / Crimp, Flexible Cable

Straight Receptacle

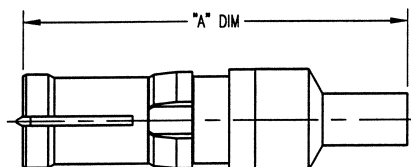

Part Number	Cable	"A" DIM
271-910-0630G	RG-179	.93
271-910-1070G	BELDEN 8218	1.03

- See page 85 for cable assembly procedures: CAP 9-01
- Part number shown is for standard gold plating.
- For military finish change suffix to "H"
- For commercial finish change suffix to "C"

Dimensions shown are in inches.

RDM 75 OHM: Solder / Crimp, Flexible Cable

Straight Plug

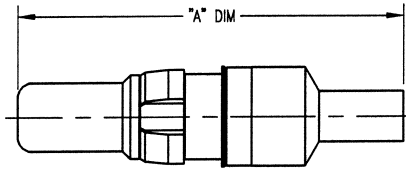

Part Number	Cable	"A" DIM
270-910-0630G	RG- 179	.93
270-910-1070G	BELDEN 8218	1.03

- See page 85 for cable assembly procedures: CAP 9-01
- Part number shown is for standard gold plating.
- For military finish change suffix to "H"
- For commercial finish change suffix to "C"

Right Angle Receptacle

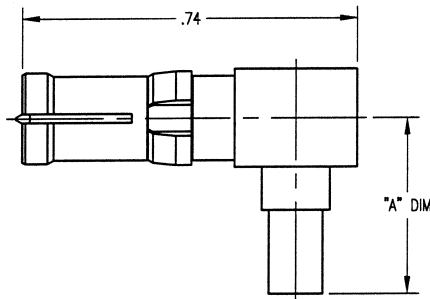

Part Number	Cable	"A" DIM
273-910-0630G	RG- 179	.49
273-910-1070G	BELDEN 8218	.60

- See page 86 for cable assembly procedures: CAP 9-02
- Part number shown is for standard gold plating.
- For military finish change suffix to "H"
- For commercial finish change suffix to "C"

Right Angle Plug

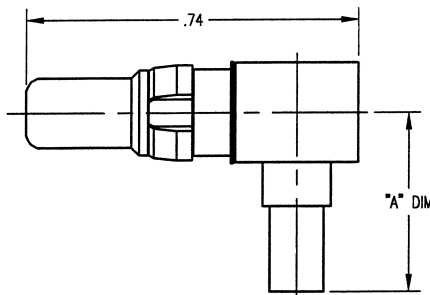

Part Number	Cable	"A" DIM
272-910-0630G	RG- 179	.49
272-910-1070G	BELDEN 8218	.60

- See page 86 for cable assembly procedures: CAP 9-02
- Part number shown is for standard gold plating.
- For military finish change suffix to "H"
- For commercial finish change suffix to "C"

RDM 75 OHM: Crimp / Crimp, Flexible Cable

Straight Receptacle

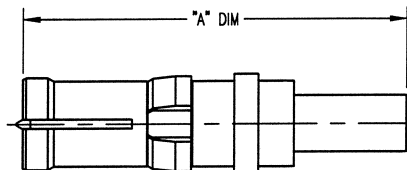

Part Number	Cable	"A" DIM
241-910-0630G	RG- 179	.84
241-910-1070G	BELDEN 8218	1.00

- See page 87 for cable assembly procedures: CAP 9-07
- Part number shown is for standard gold plating.
- For military finish change suffix to "H"
- For commercial finish change suffix to "C"

Straight Plug

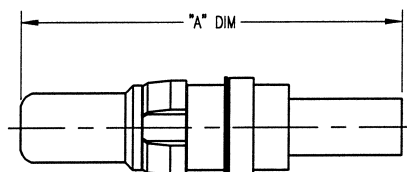

Part Number	Cable	"A" DIM
240-910-0630G	RG- 179	.86
240-910-1070G	BELDEN 8218	1.01

- See page 87 for cable assembly procedures: CAP 9-07
- Part number shown is for standard gold plating.
- For military finish change suffix to "H"
- For commercial finish change suffix to "C"

Dimensions shown are in inches.

RDM 75 OHM: Printed Circuit Board Contacts

Straight Receptacle

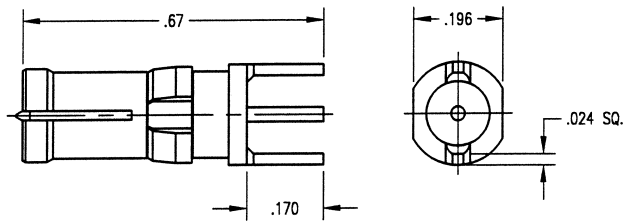

Part Number	Mounting Hole
271-010-6140G	No. 061

- See page 78 for mounting hole layout.
- Part number shown is for standard gold plating.
- For military finish change suffix to "H"
- For commercial finish change suffix to "C"

Straight Plug

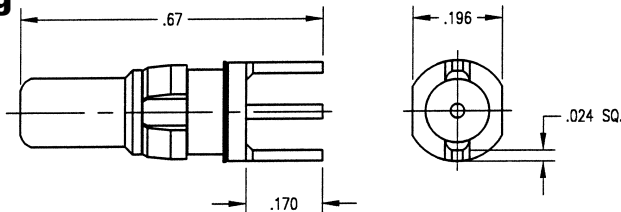

Part Number	Mounting Hole
270-010-6140G	No. 061

- See page 78 for mounting hole layout.
- Part number shown is for standard gold plating.
- For military finish change suffix to "H"
- For commercial finish change suffix to "C"

Right Angle Receptacle

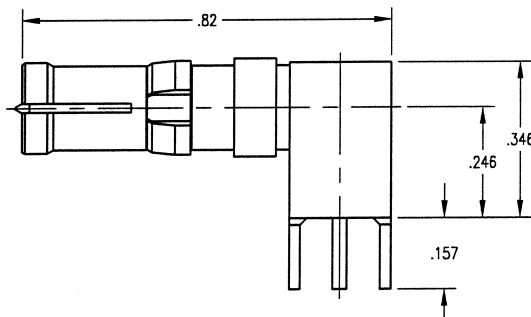

Part Number	Mounting Hole
273-010-6140G	No. 061

- See page 78 for mounting hole layout.
- Part number shown is for standard gold plating.
- For military finish change suffix to "H"
- For commercial finish change suffix to "C"

Right Angle Plug

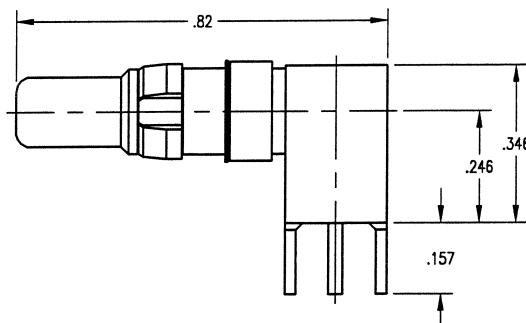

Part Number	Mounting Hole
272-010-6140G	No. 061

- See page 78 for mounting hole layout.
- Part number shown is for standard gold plating.
- For military finish change suffix to "H"
- For commercial finish change suffix to "C"

RDM 75 OHM: Same - Series Adapters

Receptacle / Receptacle

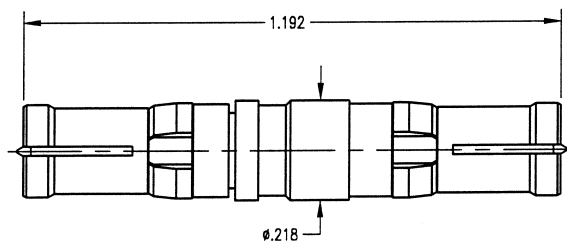

Part Number
271-271-0000G

- Part number shown is for standard gold plating.
- For military finish change suffix to "H"
- For commercial finish change suffix to "C"

Dimensions shown are in inches.

RDM 75 OHM: Same - Series Adapters

Plug / Plug

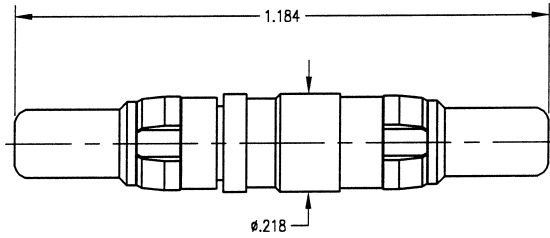

Part Number
270-270-0000G

- Part number shown is for standard gold plating.
- For military finish change suffix to "H"
- For commercial finish change suffix to "C"

Plug / Receptacle

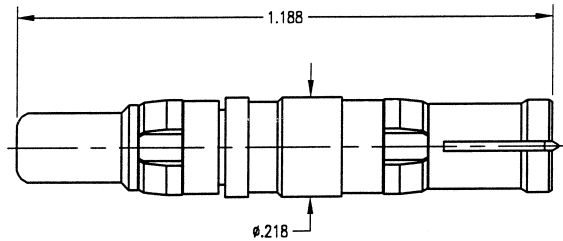

Part Number
270-271-0000G

- Part number shown is for standard gold plating.
- For military finish change suffix to "H"
- For commercial finish change suffix to "C"

Dimensions shown are in inches.

RDM HIGH POWER: Specifications & Interface Dimensions

MECHANICAL:

Materials:

- Bodies, Plugs: Brass per ASTM B16, 1/2 HD
- Bodies Receptacles: Beryllium Copper per ASTM B196
- Spring Washers: Phosphor Bronze per ASTM B103
- Clip Ring: Phosphor Bronze per ASTM B103

Finish:

- Bodies: Gold Plated per MIL-STD-45204
- Clip Ring: Nickel Plated per QQ-N-290

MATING CHARACTERISTICS:

Receptacles, Outer Contact: 3 lbs. Maximum Insertion on a .1530 +.0001 / -.0000 Dia. Pin and a 4 oz. Minimum Withdrawal on a .1500 +.0000 / -.0001 Dia. Pin

Retention in Shell: 15 lbs. Minimum

ELECTRICAL:

- Current Rating: 10, 20, 40 AMPS
- Contact Resistance: 3.0 Milliohms

ENVIRONMENTAL:

- Operating Temperature: -55°C to +125°C
- Vibration: MIL-STD-202, Method 204, Test Condition D
- Shock: MIL-STD-202, Method 213, Test Condition I
- Corrosion Resistance: MIL-STD-202, Method 101, Condition B

GENERAL INFORMATION:

RDM Coaxial Contacts fit all D-Subminiature Connectors and are interchangeable with other manufacturer's product. Available in crimp or solder cable terminations.

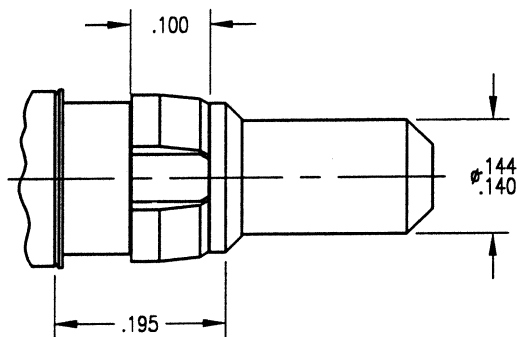

Plug Interface

Receptacle Interface

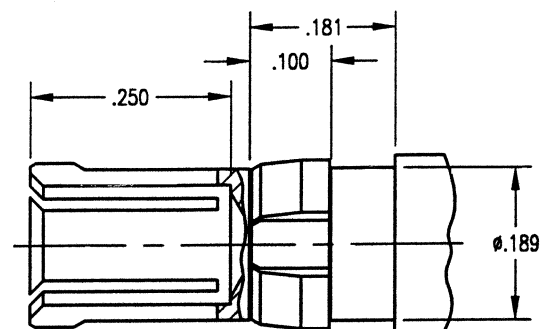

Dimensions shown are in inches.

Winchester/Retconn

400 Park Road • Watertown, Connecticut 06795-5000 • Phone: (860) 945-5000 • FAX: (860) 945-3950 • Internet: <http://www.litton-wed.com>

DS/25

RDM HIGH POWER: Solder, Flexible Cable

Straight Receptacle

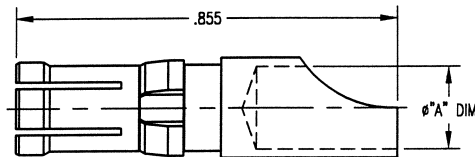

Part Number	Wire Gauge	Current Rating	"A" DIM
221-510-0000G	# 8	40 AMP	.188
221-510-0001G	# 12	20 AMP	.110
221-510-0002G	# 16	10 AMP	.069

- Part number shown is for standard gold plating.
- For military finish change suffix to "H"
- For commercial finish change suffix to "C"

Straight Plug

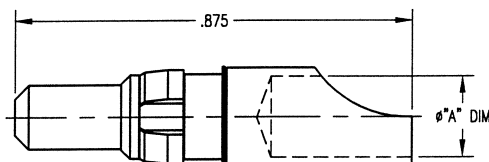

Part Number	Wire Gauge	Current Rating	"A" DIM
220-510-0000G	# 8	40 AMP	.188
220-510-0001G	# 12	20 AMP	.110
220-510-0002G	# 16	10 AMP	.069

- Part number shown is for standard gold plating.
- For military finish change suffix to "H"
- For commercial finish change suffix to "C"

Right Angle Receptacle

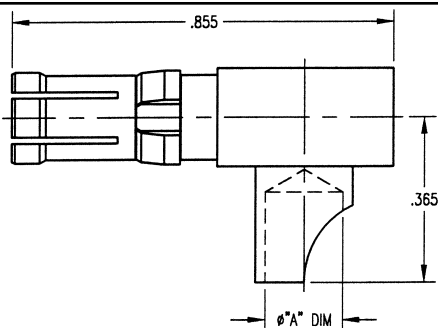

Part Number	Wire Gauge	Current Rating	"A" DIM
223-510-0000G	# 8	40 AMP	.188
223-510-0001G	# 12	20 AMP	.110
223-510-0002G	# 16	10 AMP	.069

- Part number shown is for standard gold plating.
- For military finish change suffix to "H"
- For commercial finish change suffix to "C"

Right Angle Plug

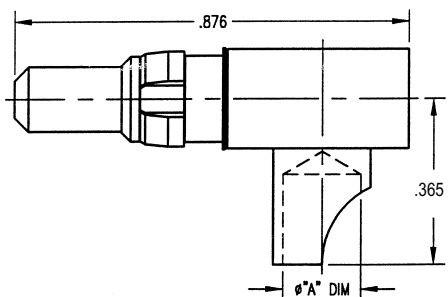

Part Number	Wire Gauge	Current Rating	"A" DIM
222-510-0000G	# 8	40 AMP	.188
222-510-0001G	# 12	20 AMP	.110
222-510-0002G	# 16	10 AMP	.069

- Part number shown is for standard gold plating.
- For military finish change suffix to "H"
- For commercial finish change suffix to "C"

RDM HIGH POWER: Crimp, Flexible Cable

Straight Receptacle

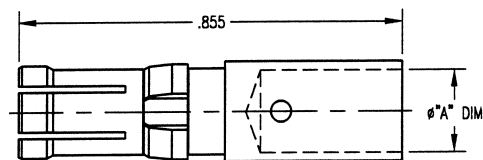

Part Number	Wire Gauge	Current Rating	"A" DIM
221-910-0000G	# 8	40 AMP	.188
221-910-0001G	# 12	20 AMP	.110
221-910-0002G	# 16	10 AMP	.069

- Part number shown is for standard gold plating.
- For military finish change suffix to "H"
- For commercial finish change suffix to "C"

Dimensions shown are in inches.

RDM HIGH POWER: Crimp, Flexible Cable

Straight Plug

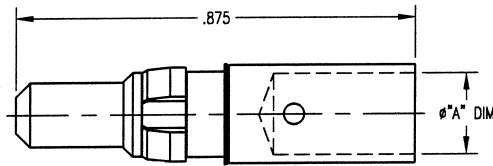

Part Number	Wire Gauge	Current Rating	"A" DIM
220-910-0000G	# 8	40 AMP	.188
220-910-0001G	# 12	20 AMP	.110
220-910-0002G	# 16	10 AMP	.069

- Part number shown is for standard gold plating.
- For military finish change suffix to "H"
- For commercial finish change suffix to "C"

Right Angle Receptacle

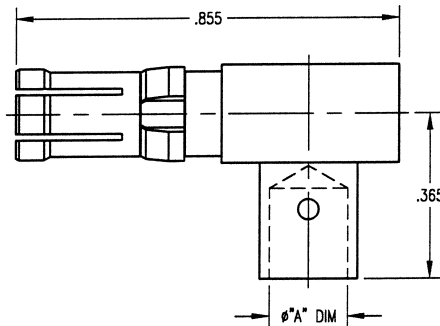

Part Number	Wire Gauge	Current Rating	"A" DIM
223-910-0000G	# 8	40 AMP	.188
223-910-0001G	# 12	20 AMP	.110
223-910-0002G	# 16	10 AMP	.069

- Part number shown is for standard gold plating.
- For military finish change suffix to "H"
- For commercial finish change suffix to "C"

Right Angle Plug

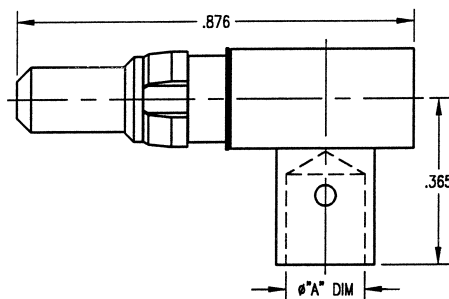

Part Number	Wire Gauge	Current Rating	"A" DIM
222-910-0000G	# 8	40 AMP	.188
222-910-0001G	# 12	20 AMP	.110
222-910-0002G	# 16	10 AMP	.069

- Part number shown is for standard gold plating.
- For military finish change suffix to "H"
- For commercial finish change suffix to "C"

RDM HIGH VOLTAGE: Solder, Flexible Cable

Straight Plug

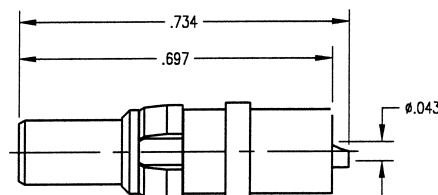

Part Number	Wire Gauge
230-510-0000H	# 16

- Part number shown is for standard gold plating.
- For military finish change suffix to "H"
- For commercial finish change suffix to "C"

Straight Receptacle

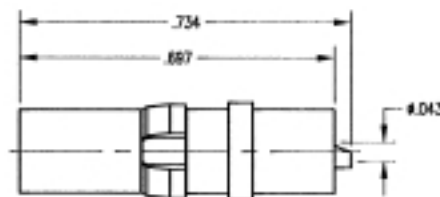

Part Number	Wire Gauge
231-510-0000H	# 16

- Part number shown is for standard gold plating.
- For military finish change suffix to "H"
- For commercial finish change suffix to "C"

Dimensions shown are in inches.

RDM HIGH VOLTAGE: Solder, Flexible Cable

Right Angle Receptacle

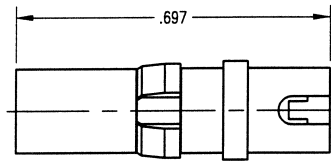

Part Number	Wire Gauge
233-510-0000H	# 16

- Part number shown is for standard gold plating.
- For military finish change suffix to "H"
- For commercial finish change suffix to "C"

Right Angle Plug

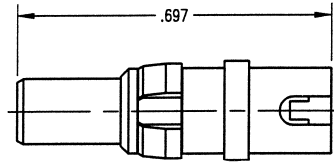

Part Number	Wire Gauge
232-510-0000H	# 16

- Part number shown is for standard gold plating.
- For military finish change suffix to "H"
- For commercial finish change suffix to "C"

Dimensions shown are in inches.

40 SERIES: Specifications & Interface Dimensions

MECHANICAL:

Materials:

Bodies, Plugs: Brass per ASTM B16, 1/2 HD
Bodies Receptacles: Beryllium Copper per ASTM B196
Female Contacts: Beryllium Copper per ASTM B196
Male Contacts: Brass per ASTM B16, 1/2 HD
Insulators: Teflon per ASTM D1710
Crimp Ferrule: Annealed Copper Alloy
Clip Ring: Beryllium Copper per ASTM B194

Finish:

Body: Gold Plated per MIL-STD-45204
Center Contact: Gold Plated per MIL-STD-45204
Clip Ring: Nickel Plated per QQ-N-290

MATING CHARACTERISTICS:

Receptacles, Outer Contact: 3 lbs. Maximum Insertion on a $.1530 +.0001 / -.0000$ Dia. Pin and a 4 oz. Minimum Withdrawl on a $.1500 +.0000 / -.0001$ Dia. Pin

Plugs, Center Contact: 16 oz. Maximum on a $.0410 +.0001 / -.0000$ Dia. Pin and 5 oz. Minimum Withdrawl on a $.0390 +.0000 / -.0001$ Dia. Pin

Retension in Shell: 15 lbs. Minimum

ELECTRICAL:

Impedance: 50 Ohms Nominal
Frequency Range: 0 to 5.0 GHz
Insulation Resistance: 5000 Megaohms Minimum
Contact Resistance: (Milliohms Maximum)
Center Contact: 5.0
Outer Contact: 3.0
Voltage Standing Wave Ratio: 0 to 5.0 GHz
Straight Connector: $1.15 +.02F$ GHz on RG-316 Cable
Straight Connector: $1.15 +.01F$ GHz on .141 Dia. Semi-rigid Cable

ENVIRONMENTAL:

Operating Temperature: -55°C to $+125^{\circ}\text{C}$
Vibration: MIL-STD-202, Method 204, Test Condition D
Shock: MIL-STD-202, Method 213, Test Condition I
Corrosion Resistance: MIL-STD-202, Test Method 101, Condition B

GENERAL INFORMATION:

31 Series Coaxial Contacts fit housings per DIN 41612
Available in crimp or solder cable terminations

Plug Interface

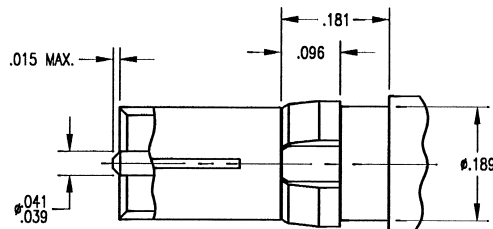
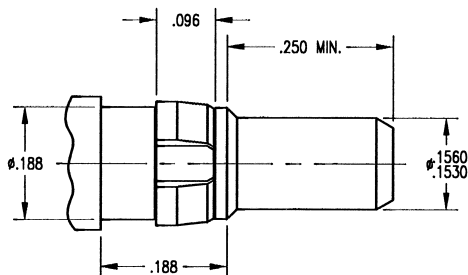

Receptacle Interface

Dimensions shown are in inches.

Winchester/Retconn

RDM 40 SERIES: Printed Circuit Board Contacts

Straight Plug

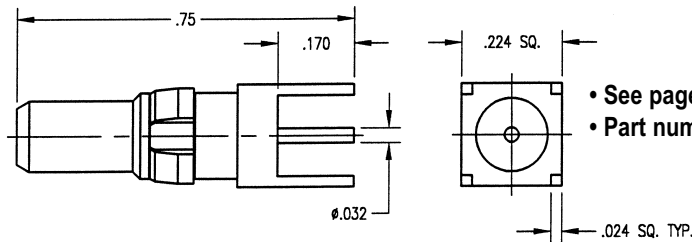

Part Number	Mounting Hole
400-010-6040G	No. 060A

- See page 78 for mounting hole layout.
- Part number shown is for standard gold plating.

Straight Receptacle

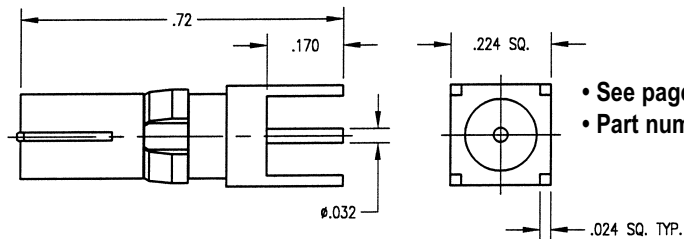

Part Number	Mounting Hole
401-010-6040G	No. 060A

- See page 78 for mounting hole layout.
- Part number shown is for standard gold plating.

Right Angle Plug

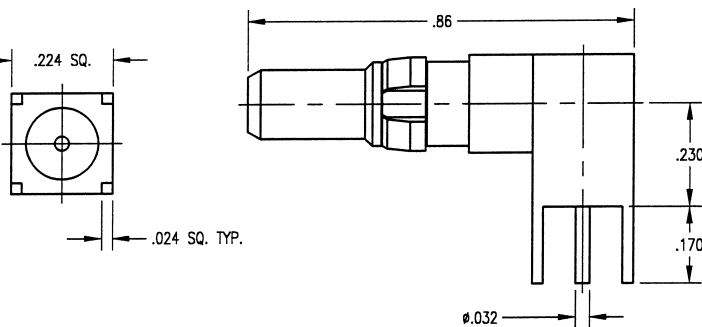

Part Number	Mounting Hole
402-010-6040G	No. 060A

- See page 78 for mounting hole layout.
- Part number shown is for standard gold plating.

Right Angle Receptacle

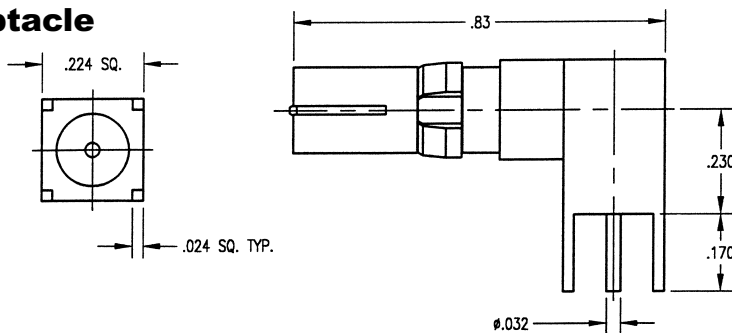

Part Number	Mounting Hole
403-010-6040G	No. 060A

- See page 78 for mounting hole layout.
- Part number shown is for standard gold plating.

Straight Plug

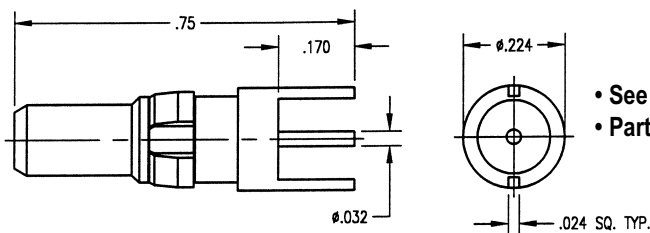

Part Number	Mounting Hole
400-010-6140G	No. 061

- See page 78 for mounting hole layout.
- Part number shown is for standard gold plating.

Dimensions shown are in inches.

RDM 40 SERIES: Printed Circuit Board Contacts

Straight Receptacle

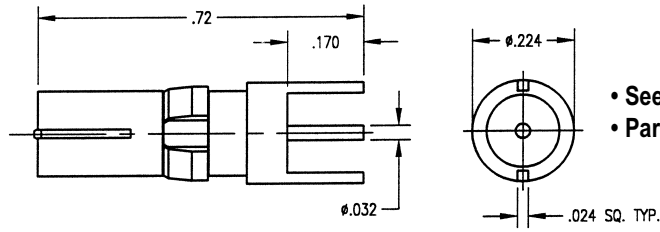

Part Number	Mounting Hole
401-010-6140G	No. 061

- See page 78 for mounting hole layout.
- Part number shown is for standard gold plating.

Right Angle Plug

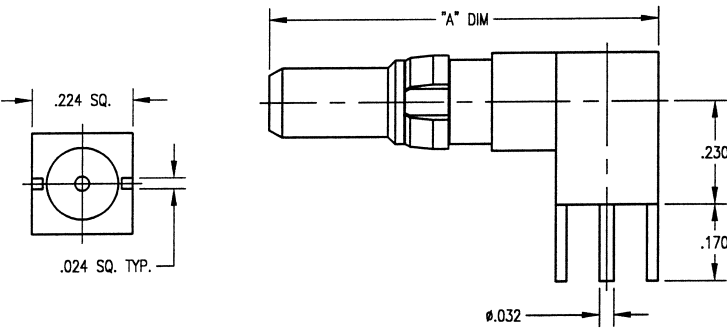

Part Number	Mounting Hole	"A" DIM
402-010-6140G	No. 061	.76
402-010-6141G	No. 061	.86

- See page 78 for mounting hole layout.
- Part number shown is for standard gold plating.

Right Angle Receptacle

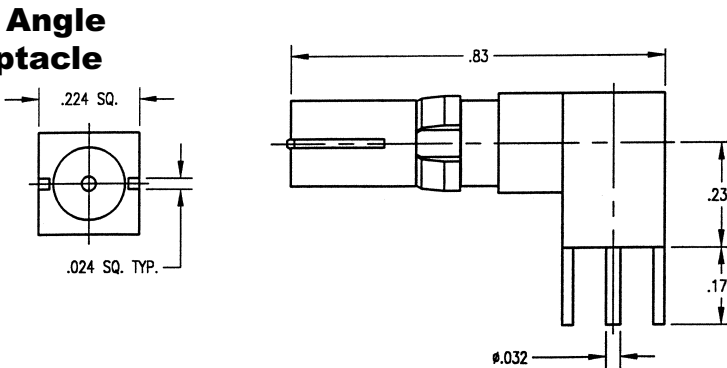

Part Number	Mounting Hole
403-010-6140G	No. 061

- See page 78 for mounting hole layout.
- Part number shown is for standard gold plating.

RDM 40 SERIES: Crimp / Crimp, Flexible Cable

Straight Plug

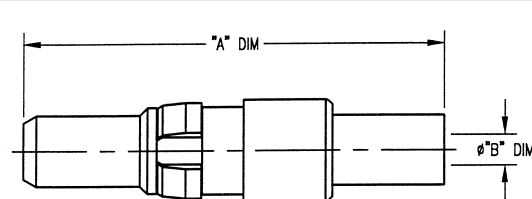

Part Number	Cable	"A" DIM	"B" DIM
400-910-0630G	RG- 316, 188	.93	.067
400-910-0631G	RG- 316, DS	.93	.067
400-910-1160G	RG- 141, 58	1.09	.120
400-910-1161G	RG- 142, 223	1.09	.120

- See page 87 for cable assembly procedures: CAP 9-07
- Part number shown is for standard gold plating.

Straight Receptacle

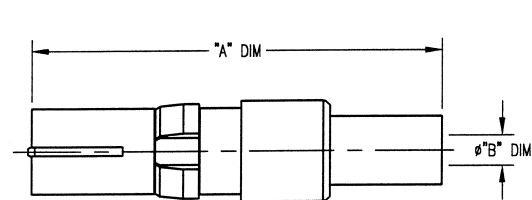

Part Number	Cable	"A" DIM	"B" DIM
401-910-0630G	RG- 316, 188	.86	.067
401-910-0631G	RG-316, DS	.86	.067
401-910-1160G	RG-141, 58	1.02	.120
401-910-1161G	RG- 142, 223	1.02	.120

- See page 87 for cable assembly procedures: CAP 9-07
- Part number shown is for standard gold plating.

Dimensions shown are in inches.

RDM 40 SERIES: Crimp / Crimp, Flexible Cable

Right Angle Plug

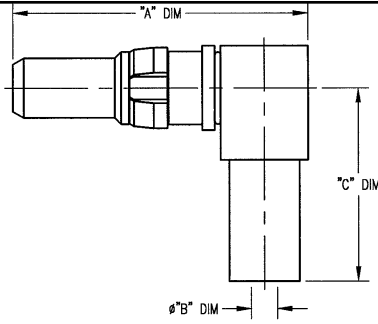

Part Number	Cable	"A" DIM	"B" DIM	"C" DIM
402-910-0630G	RG- 316, 188	.75	.067	.50
402-910-0631G	RG- 316, DS	.75	.067	.50
402-910-1160G	RG- 141, 58	.75	.120	.60
402-910-1161G	RG- 142, 223	.75	.120	.60

- See page 88 for cable assembly procedures: CAP 9-16
- Part number shown is for standard gold plating.

Right Angle Receptacle

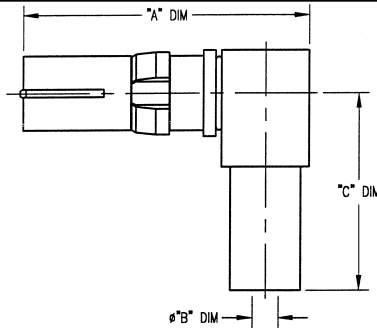

Part Number	Cable	"A" DIM	"B" DIM	"C" DIM
403-910-0630G	RG- 316, 188	.71	.067	.50
403-910-0631G	RG- 316, DS	.71	.067	.50
403-910-1160G	RG- 141, 58	.71	.120	.60
403-910-1161G	RG- 142, 223	.71	.120	.60

- See page 88 for cable assembly procedures: CAP 9-16
- Part number shown is for standard gold plating.

RDM 40 SERIES: Solder / Solder, Semi-Rigid Cable

Straight Plug

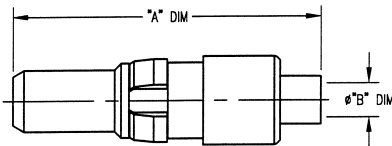

Part Number	Cable	"A" DIM	"B" DIM
400-510-0850G	RG- 405 (.085 SR)	.79	.090
400-510-1410G	RG- 402 (.141 SR)	.79	.148

- See page 83 for cable assembly procedures: CAP 5-15
- Part number shown is for standard gold plating.

Straight Receptacle

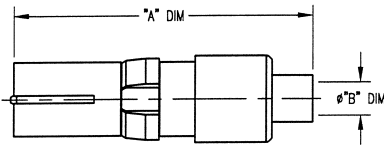

Part Number	Cable	"A" DIM	"B" DIM
401-510-0850G	RG- 405 (.085 SR)	.72	.090
401-510-1410G	RG- 402 (.141 SR)	.72	.148

- See page 83 for cable assembly procedures: CAP 5-15
- Part number shown is for standard gold plating.

Right Angle Plug

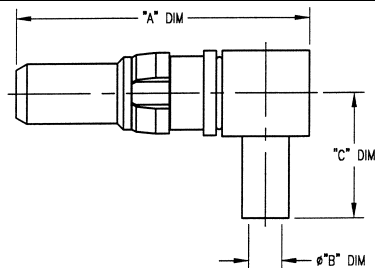

Part Number	Cable	"A" DIM	"B" DIM	"C" DIM
402-510-0850G	RG- 405 (.085 SR)	.75	.090	.31
402-510-1410G	RG- 402 (.141 SR)	.75	.148	.31

- See page 84 for cable assembly procedures: CAP 5-16
- Part number shown is for standard gold plating.

Right Angle Receptacle

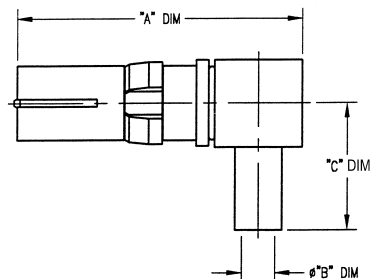

Part Number	Cable	"A" DIM	"B" DIM	"C" DIM
403-510-0850G	RG- 405 (.085 SR)	.69	.090	.31
403-510-1410G	RG- 402 (.141 SR)	.69	.148	.31

- See page 84 for cable assembly procedures: CAP 5-16
- Part number shown is for standard gold plating.

Dimensions shown are in inches.

Winchester/Retconn

D-SUBMINIATURE: Connector Ordering Guide

Standard Housings

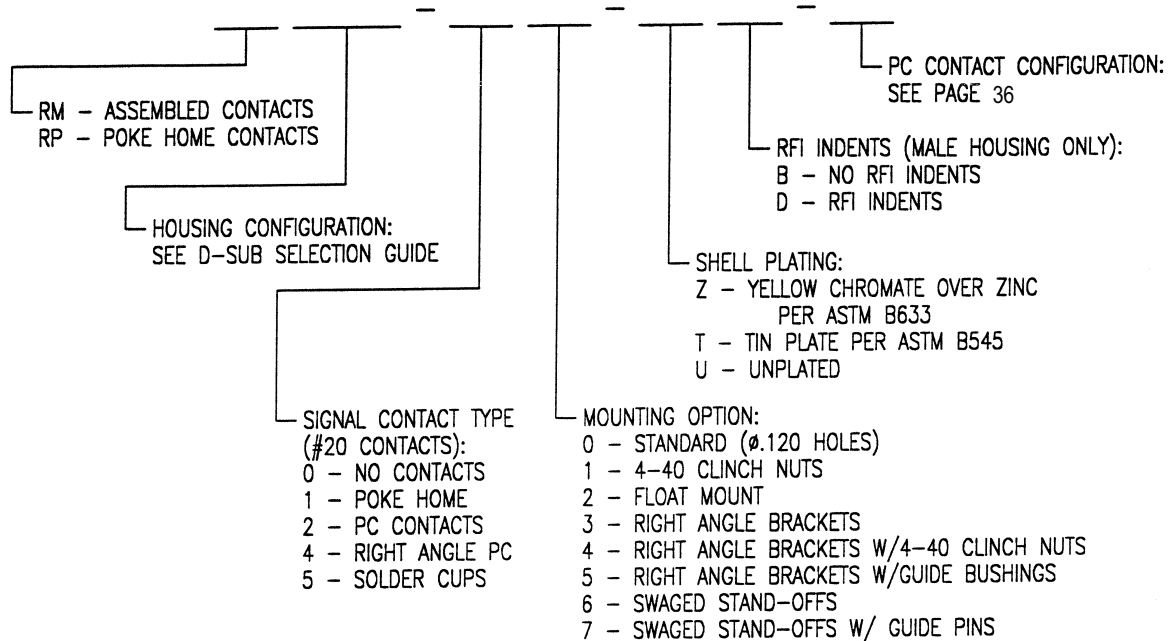

Example: RM2W7P-50-TD= 24W7 Male Housing, With Assembled Solder Cup Contacts, Tin Plated, With RFI Indents, And Standard Mounting

Edgemount D-Subminiature Connectors (RM - 2000 Series)

Note: Edgemount Coaxial Connectors are supplied installed in housing

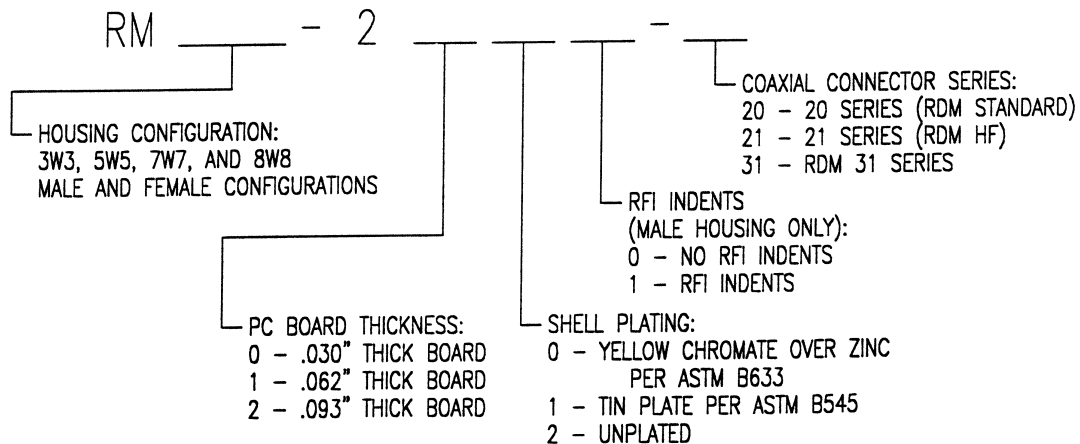

Example: RM5W5P-2010-20= 5W5 Male Edgemount Housing, Tin Plated, Without RFI Indents, With RDM 20 Series Coaxial Connectors, For Use In A .030" Thick PC Board.

D-SUBMINIATURE CONNECTOR: Selection Guide

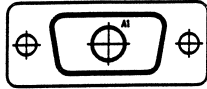

1W1

No. of size 8 contacts: 1
No. of size 20 contacts: 0

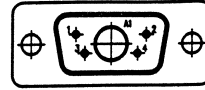

5W1

No. of size 8 contacts: 1
No. of size 20 contacts: 4

Shell Size E

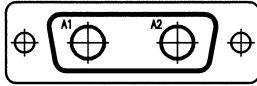

2W2

No. of size 8 contacts: 2
No. of size 20 contacts: 0

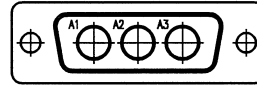

3W3

No. of size 8 contacts: 3
No. of size 20 contacts: 0

Shell Size A

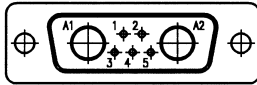

7W2

No. of size 8 contacts: 2
No. of size 20 contacts: 5

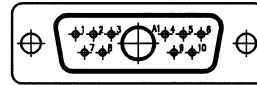

11W1

No. of size 8 contacts: 1
No. of size 20 contacts: 10

Shell Size B

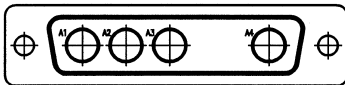

4W4

No. of size 8 contacts: 4
No. of size 20 contacts: 0

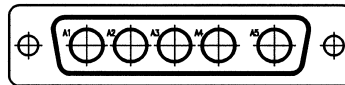

5W5

No. of size 8 contacts: 5
No. of size 20 contacts: 0

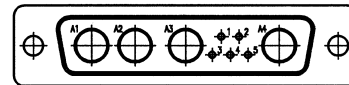

9W4

No. of size 8 contacts: 4
No. of size 20 contacts: 5

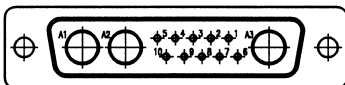

13W3

No. of size 8 contacts: 3
No. of size 20 contacts: 10

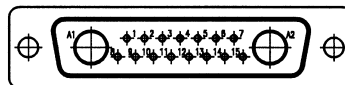

17W2

No. of size 8 contacts: 2
No. of size 20 contacts: 15

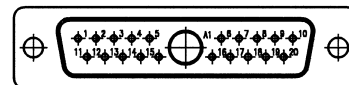

21W1

No. of size 8 contacts: 1
No. of size 20 contacts: 20

Shell Size C

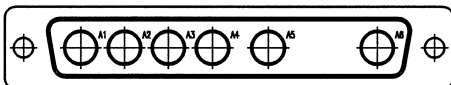

6W6

No. of size 8 contacts: 6
No. of size 20 contacts: 0

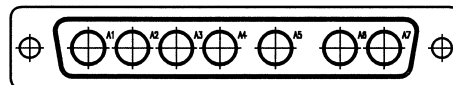

7W7

No. of size 8 contacts: 7
No. of size 20 contacts: 0

D-SUBMINIATURE CONNECTOR: Selection Guide

Shell Size C (Continued)

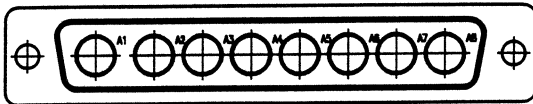

8W8

No. of size 8 contacts: 8
No. of size 20 contacts: 0

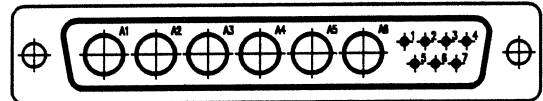

13W6

No. of size 8 contacts: 6
No. of size 20 contacts: 7



17W5

No. of size 8 contacts: 5
No. of size 20 contacts: 12



21WA4

No. of size 8 contacts: 4
No. of size 20 contacts: 17

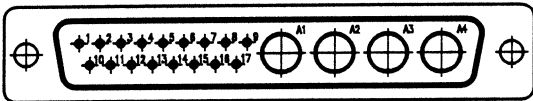

21W4

No. of size 8 contacts: 4
No. of size 20 contacts: 17



25W3

No. of size 8 contacts: 3
No. of size 20 contacts: 22

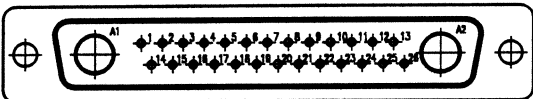

27W2

No. of size 8 contacts: 2
No. of size 20 contacts: 25

Shell Size D

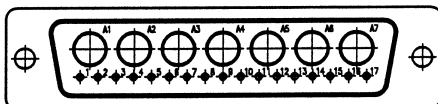

24W7

No. of size 8 contacts: 7
No. of size 20 contacts: 17

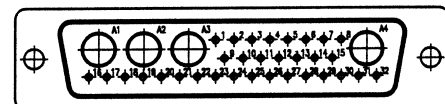

36W4

No. of size 8 contacts: 4
No. of size 20 contacts: 32

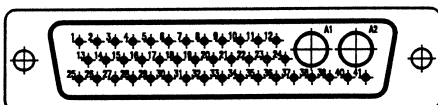

43W2

No. of size 8 contacts: 2
No. of size 20 contacts: 41

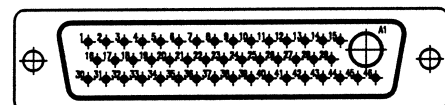

47W1

No. of size 8 contacts: 1
No. of size 20 contacts: 46

D-SUBMINIATURE: PCB Signal Contact Selection

TABLE I.

1ST LETTER DESIGNATION	CONTACT DIAMETER
A	.024
B	.030
C	.040

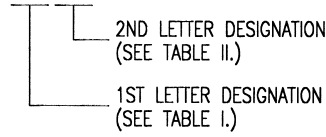

EXAMPLE: AA = .024 DIA. STRAIGHT SIGNAL CONTACTS, .154 EXTENSION BEYOND INSULATOR

TABLE II.

2ND LETTER DESIGNATION	CONTACT STYLE	"E" DIM	FIGURE
A	STRAIGHT	.154	1
B	STRAIGHT	.185	1
C	STRAIGHT	.216	1
D	STRAIGHT	.132	2
E	STRAIGHT	.163	2
F	STRAIGHT	.194	2
G	R/A	.094	3
H	R/A	.125	3
J	R/A	.157	3

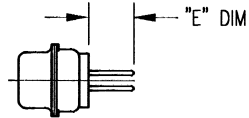

FIG. 1 - STRAIGHT CONTACTS

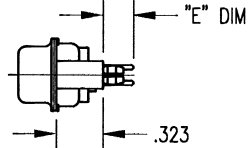

FIG. 2 - STRAIGHT CONTACTS WITH STAND-OFFS

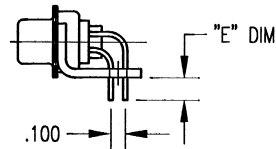
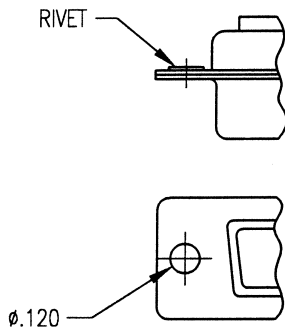

FIG. 3 - RIGHT ANGLE CONTACTS WITH BRACKETS

D-SUBMINIATURE: Mounting Options

0 - Standard



1 - 4-40 Clinch Nuts

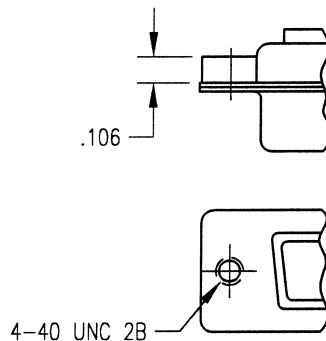

2 - Float Mount Bushings

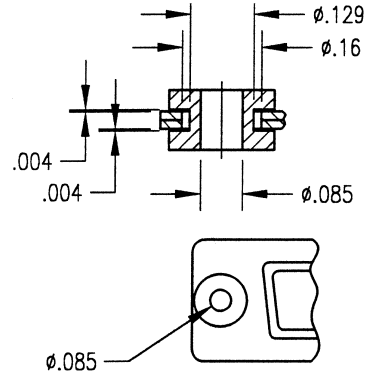

6 - Swaged Stand-Offs

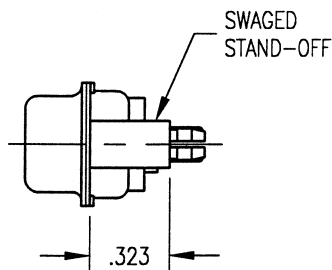

7 - Swaged Stand-Offs With Guide Pins

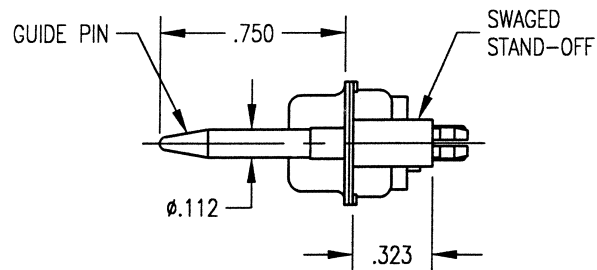

• See page 40 for right angle mounting dimensions

Dimensions shown are in inches.

Winchester/Retconn

D-SUBMINIATURE: Guide Pin Plates

Male

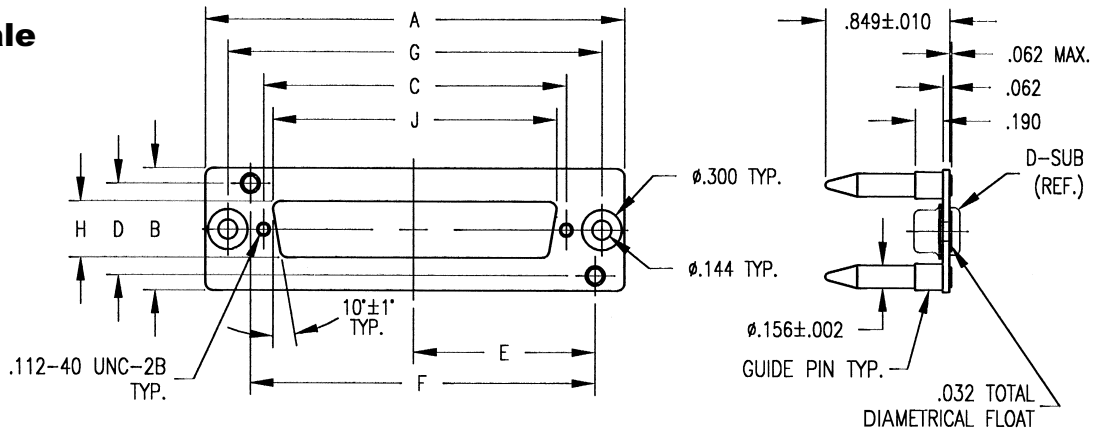

Female

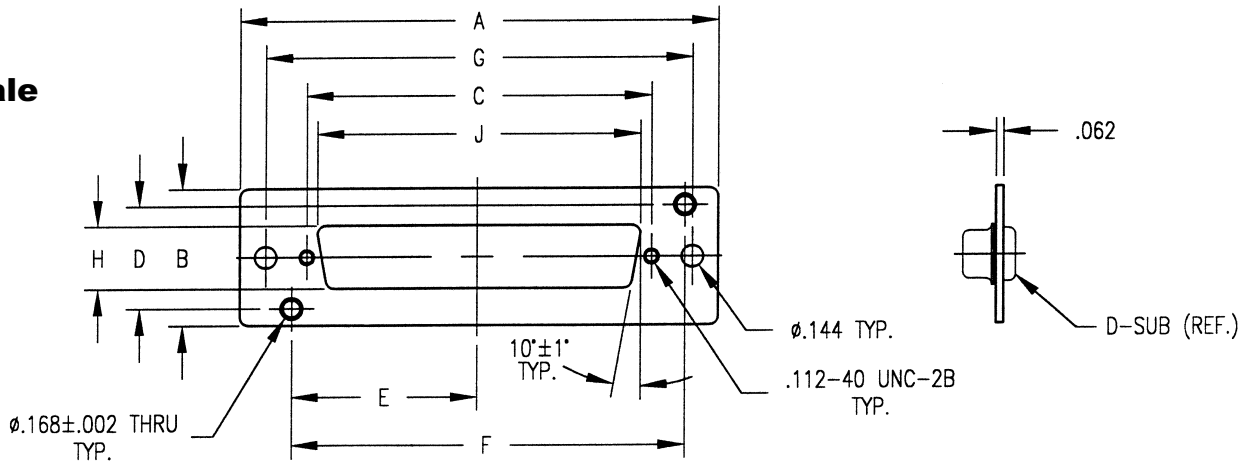

SHELL SIZE	A ±.015	B ±.015	C ±.005	D ±.003	E ±.005	F ±.003	G ±.005	H ±.005	J ±.005
E	1.953	1.000	.984	.750	.734	1.335	1.578	.458	.827
A	2.281	1.000	1.312	.750	.898	1.663	1.906	.458	1.153
B	2.820	1.000	1.852	.750	1.168	2.203	2.446	.458	1.695
C	3.468	1.000	2.500	.750	1.492	2.851	3.094	.458	2.342
D	2.275	1.125	2.406	.874	1.437	2.749	3.000	.569	2.248

Dimensions shown are in inches.

Winchester/Retconn

400 Park Road • Watertown, Connecticut 06795-5000 • Phone: (860) 945-5000 • FAX: (860) 945-3950 • Internet: <http://www.litton-wed.com>

D-SUBMINIATURE: Shell Dimensions

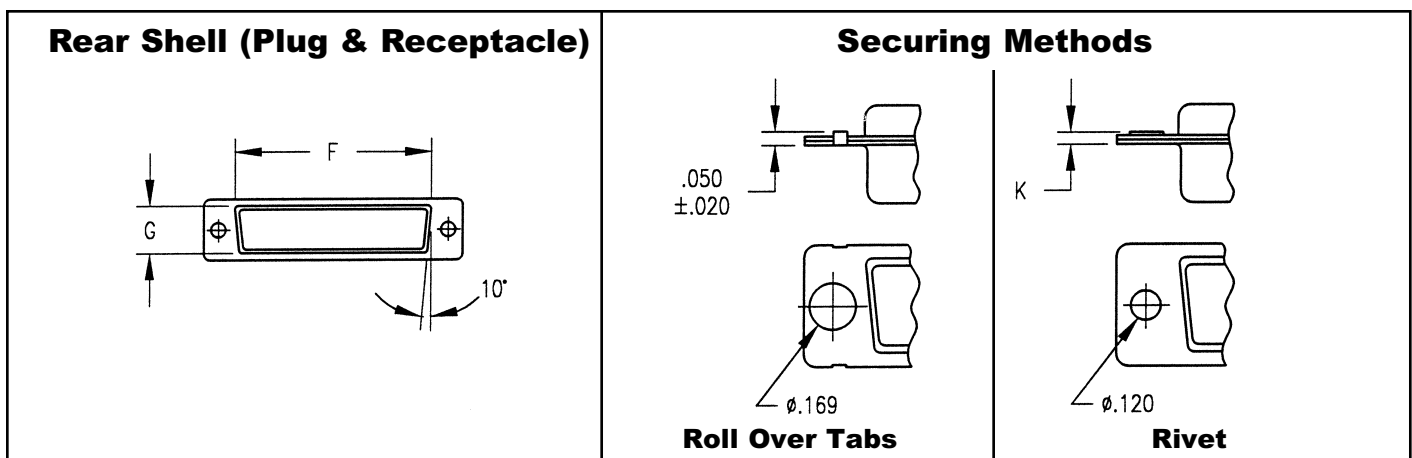
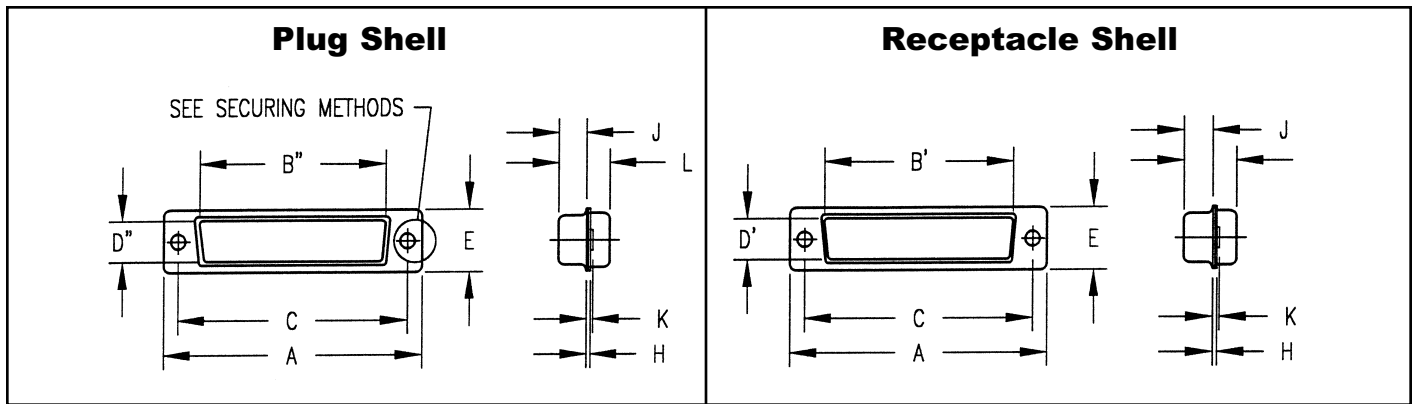

SHELL SIZE	GENDER	A ±.015	B' ±.005	B" ±.005	C ±.005	D' ±.005	D" ±.005	E ±.015	F ±.010	G ±.010	H ±.010	J	K	L ±.010
E	P	1.213	-	.666	.984	-	.329	.494	.759	.422	.030	.229/.238	.035/.060	.422
E	R	1.213	.643	-	.984	.311	-	.494	.759	.422	.030	.238/.248	.035/.060	.429
A	P	1.541	-	.994	1.312	-	.329	.494	1.083	.422	.030	.229/.238	.035/.060	.422
A	R	1.541	.971	-	1.312	.311	-	.494	1.083	.422	.030	.238/.248	.035/.060	.429
B	P	2.088	-	1.534	1.852	-	.329	.494	1.625	.422	.039	.224/.236	.050/.070	.426
B	R	2.088	1.511	-	1.852	.311	-	.494	1.625	.422	.030	.238/.248	.035/.060	.429
C	P	2.729	-	2.182	2.500	-	.329	.494	2.272	.422	.039	.224/.236	.050/.070	.426
C	R	2.729	2.159	-	2.500	.311	-	.494	2.272	.422	.030	.238/.248	.035/.060	.429
D	P	2.635	-	2.079	2.406	-	.441	.605	2.178	.534	.039	.224/.236	.050/.070	.426
D	R	2.635	2.064	-	2.406	.423	-	.605	2.178	.534	.030	.238/.248	.035/.060	.429

GENDER:

P: Plug (Pin Signal Contacts)

R: Receptacle (Socket Signal Contacts)

Dimensions shown are in inches.

Winchester/Retconn

D-SUBMINIATURE: Edgemount Connectors (Patent Information Pending)

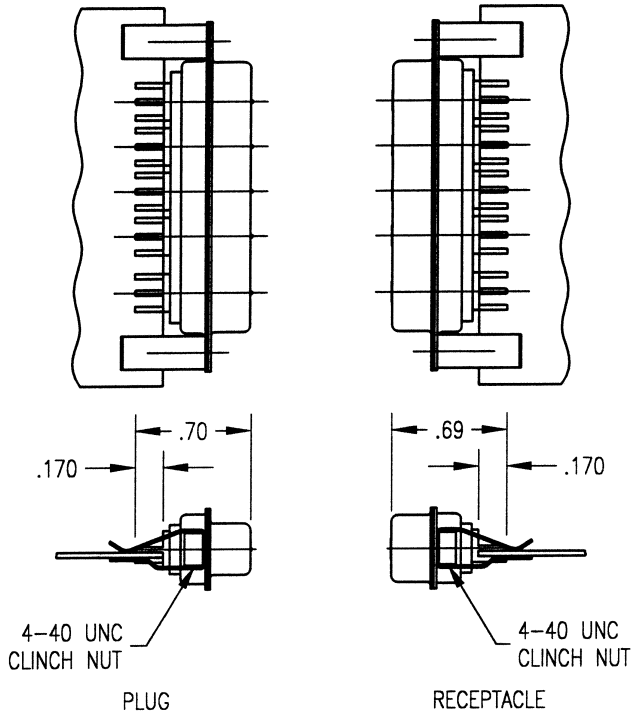

.030" THICK PC BOARD SHOWN.
ALSO AVAILABLE FOR .062" AND .093"
THICK PC BOARDS.

See page 33 for part number selection.

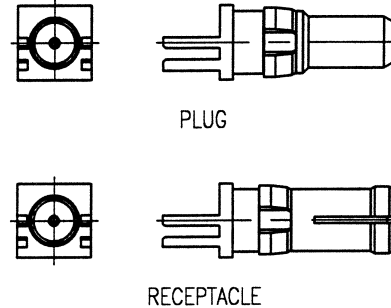

PC BOARD FOOTPRINTS (male footprint shown • female footprint is mirror image)

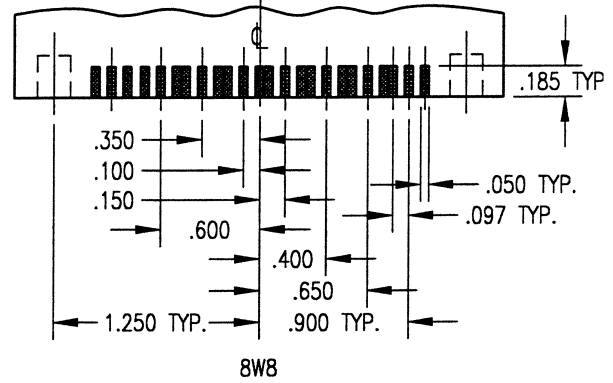
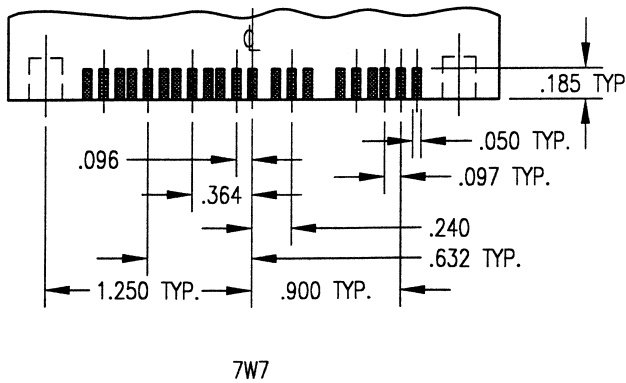
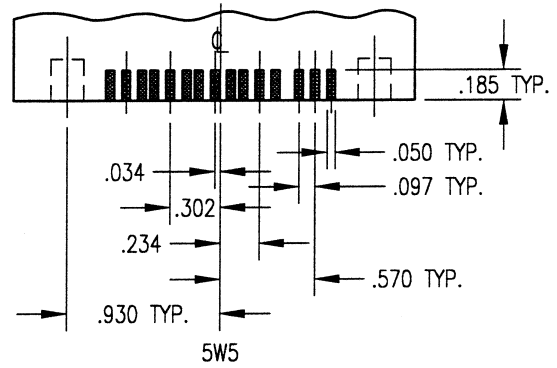
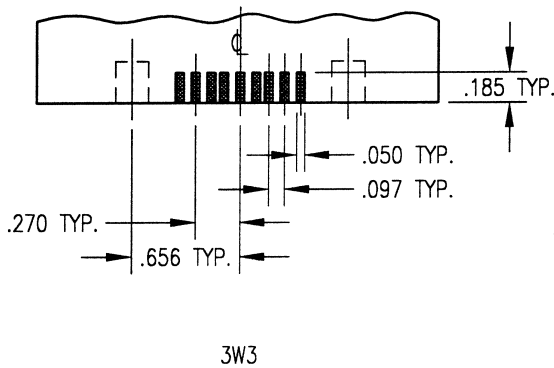

Dimensions shown are in inches.

Winchester/Retconn

D-SUBMINIATURE: Right Angle Mounting Dimensions

Right Angle Power Contacts

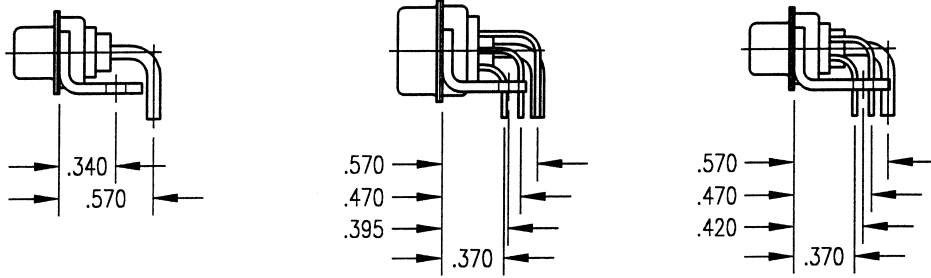

Right Angle Coaxial Contacts

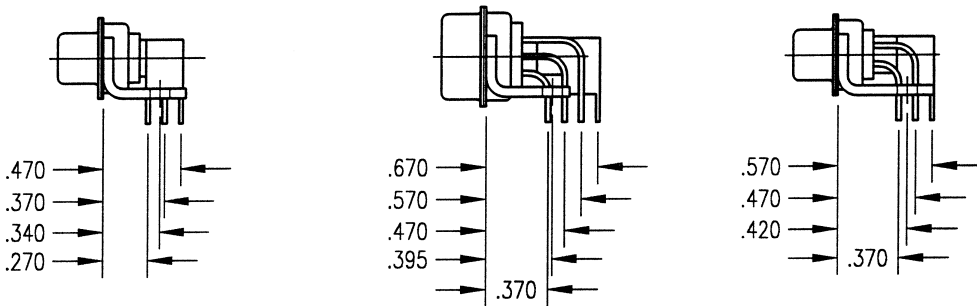

SHELL SIZE "A"
LAYOUT 2W2
3W3

SHELL SIZE "B"
LAYOUT 4W4
5W5

SHELL SIZE "C"
LAYOUT 6W6
7W7
8W8

SHELL SIZE "D"
LAYOUT 24W7
36W4
43W2
47W1

SHELL SIZE "A"
LAYOUT 7W2
11W1

SHELL SIZE "B"
LAYOUT 9W4
13W3
17W2
21W1

SHELL SIZE "C"
LAYOUT 13W6
17W5
21WA4
21W4
25W3
27W2

SHELL SIZE "E"
LAYOUT 5W1

Dimensions shown are in inches.

Winchester/Retconn

D-SUBMINIATURE CONNECTORS: Footprints

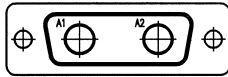

2W2
Straight Coax Contacts

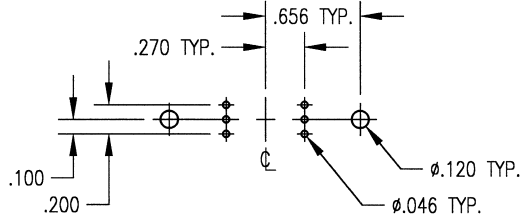

Viewed from component side of PCB.
Male footprint shown.
Female footprint mirrored.

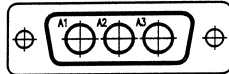

3W3
Straight Coax Contacts

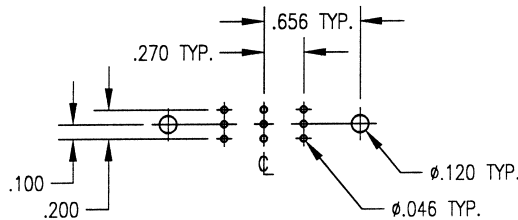

Viewed from component side of PCB.
Male footprint shown.
Female footprint mirrored.

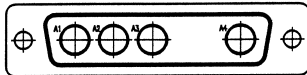

4W4
Straight Coax Contacts

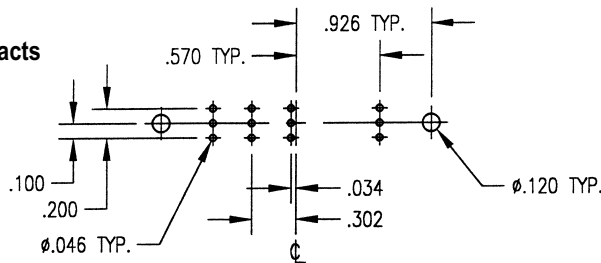

Viewed from component side of PCB.
Male footprint shown.
Female footprint mirrored.

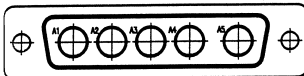

5W5
Straight Coax Contacts

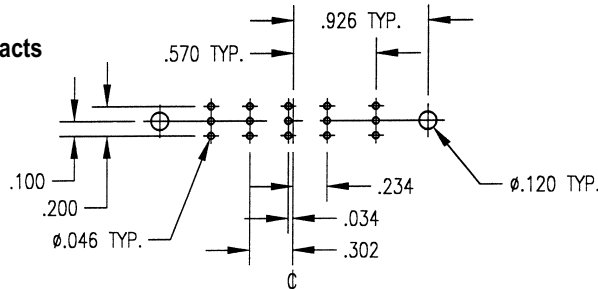

Viewed from component side of PCB.
Male footprint shown.
Female footprint mirrored.

Dimensions shown are in inches.

D-SUBMINIATURE CONNECTORS: Footprints

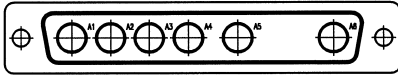

6W6
Straight Coax Contacts

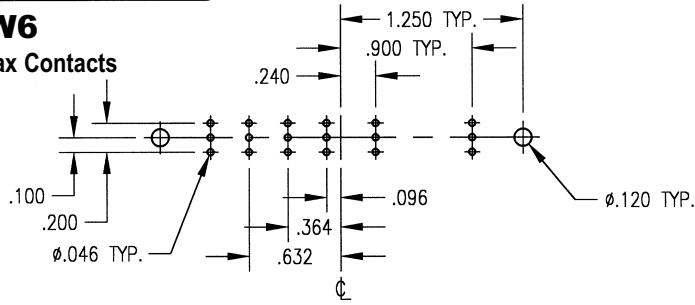

Viewed from component side of PCB.
Male footprint shown.
Female footprint is mirrored.

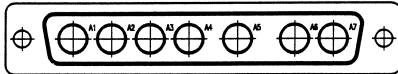

7W7
Straight Coax Contacts

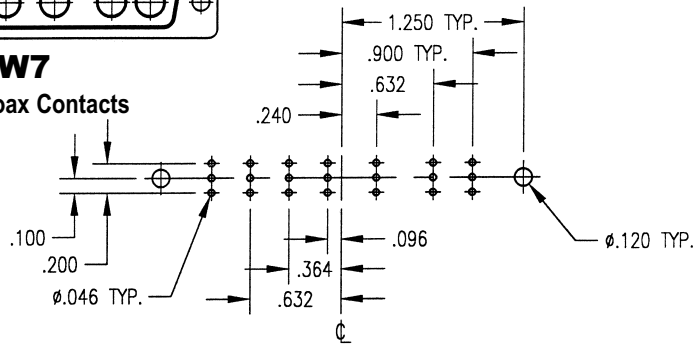

Viewed from component side of PCB.
Male footprint shown.
Female footprint is mirrored.

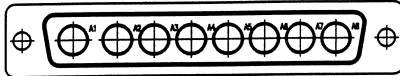

8W8
Straight Coax Contacts

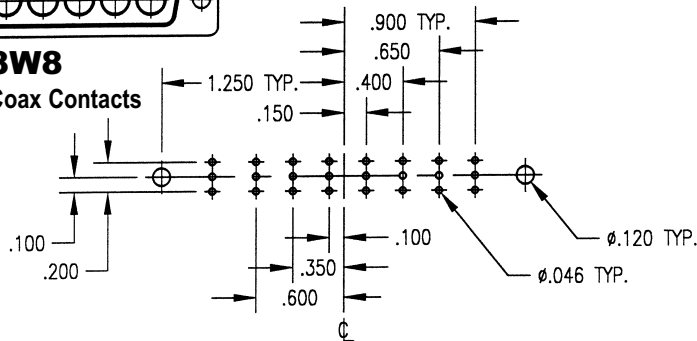

Viewed from component side of PCB.
Male footprint shown.
Female footprint is mirrored.



5W1
Straight Coax Contacts

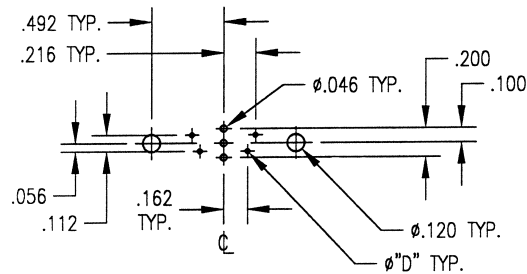

Viewed from component side of PCB.
Male footprint shown.
Female footprint is mirrored.

Signal Contact Dia.	"D" DIM.
.040	.055 MIN.
.030	.045 MIN.
.024	.040 MIN.

Dimensions shown are in inches.

D-SUBMINIATURE CONNECTORS: Footprints



7W2
Straight Coax Contacts

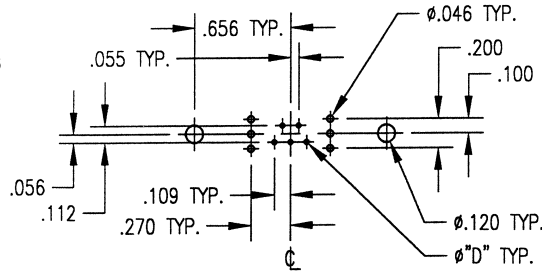

Signal Contact Dia.	"D" DIM.
.040	.055 MIN.
.030	.045 MIN.
.024	.040 MIN.

Viewed from component side of PCB.
Male footprint shown.
Female footprint is mirrored.

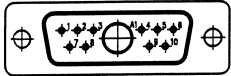

11W1
Straight Coax Contacts

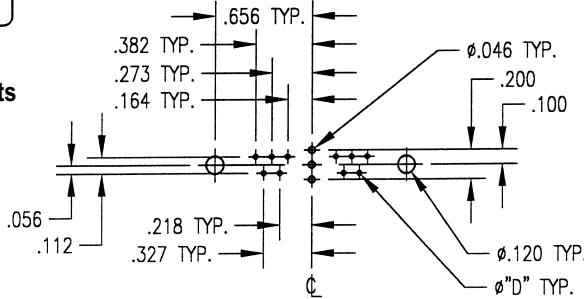

Signal Contact Dia.	"D" DIM.
.040	.055 MIN.
.030	.045 MIN.
.024	.040 MIN.

Viewed from component side of PCB.
Male footprint shown.
Female footprint is mirrored.

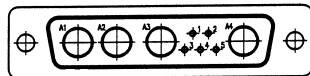

9W4
Straight Coax Contacts

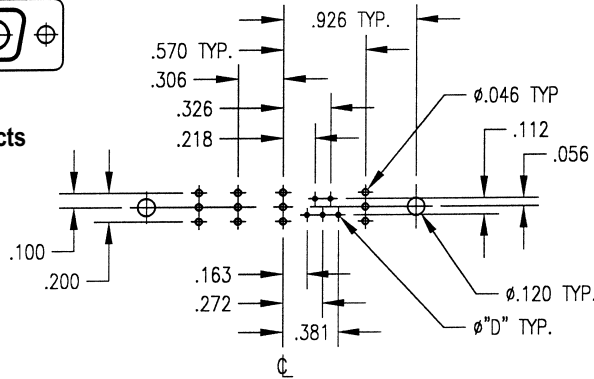

Signal Contact Dia.	"D" DIM.
.040	.055 MIN.
.030	.045 MIN.
.024	.040 MIN.

Viewed from component side of PCB.
Male footprint shown.
Female footprint is mirrored.

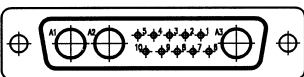

13W3
Straight Coax Contacts

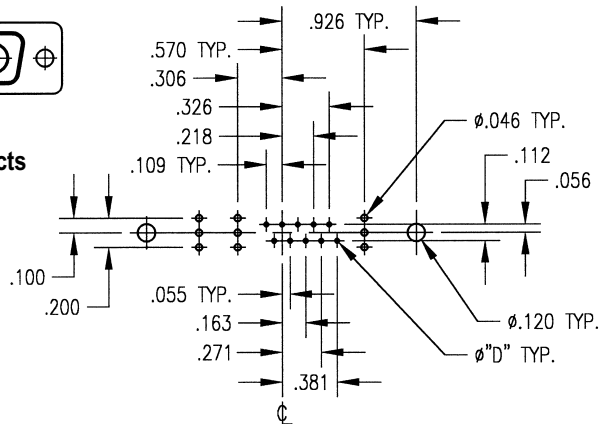

Signal Contact Dia.	"D" DIM.
.040	.055 MIN.
.030	.045 MIN.
.024	.040 MIN.

Viewed from component side of PCB.
Male footprint shown.
Female footprint is mirrored.

Dimensions shown are in inches.

D-SUBMINIATURE CONNECTORS: Footprints



17W2
Straight Coax Contacts

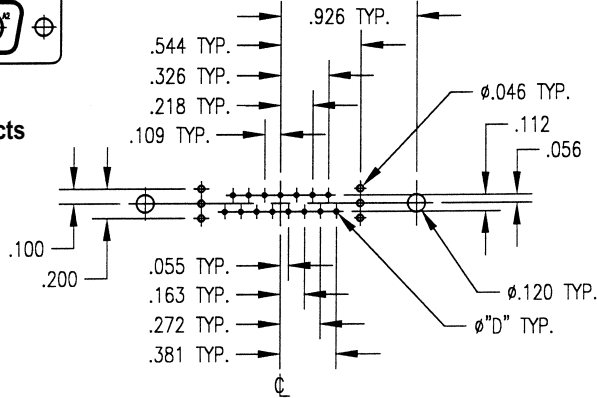

Signal Contact Dia. "D" DIM.	
.040	.055 MIN.
.030	.045 MIN.
.024	.040 MIN.

Viewed from component side of PCB.
Male footprint shown.
Female footprint is mirrored.

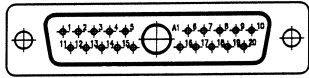

21W1
Straight Coax Contacts

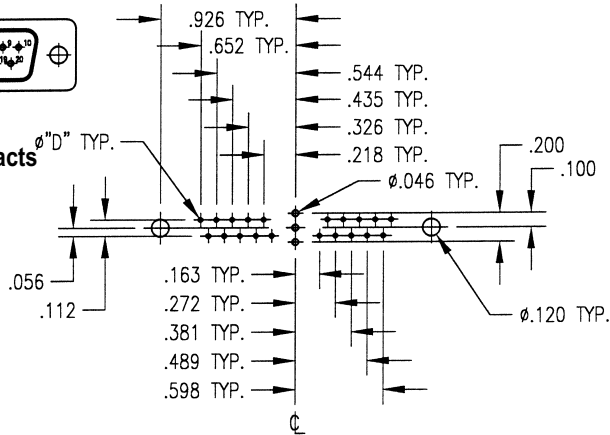

Signal Contact Dia. "D" DIM.	
.040	.055 MIN.
.030	.045 MIN.
.024	.040 MIN.

Viewed from component side of PCB.
Male footprint shown.
Female footprint is mirrored.

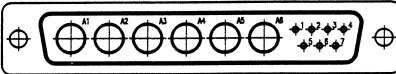

13W6
Straight Coax Contacts

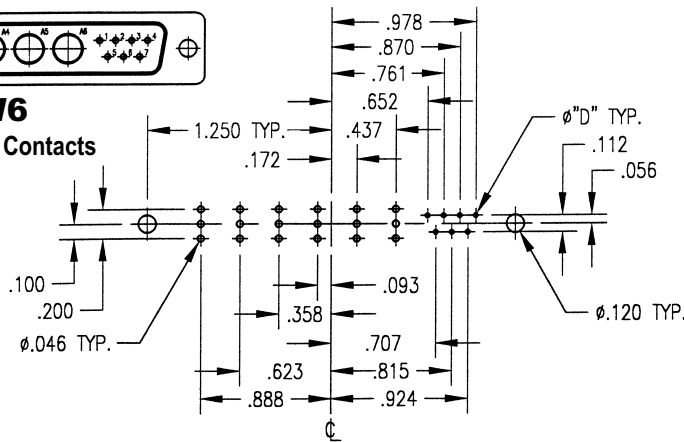

Signal Contact Dia. "D" DIM.	
.040	.055 MIN.
.030	.045 MIN.
.024	.040 MIN.

Viewed from component side of PCB.
Male footprint shown.
Female footprint is mirrored.

Dimensions shown are in inches.

D-SUBMINIATURE CONNECTORS: Footprints



17W5

Straight Coax Contacts

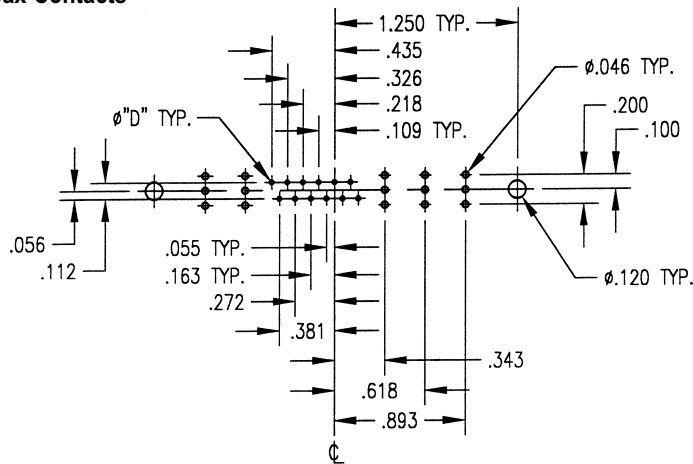

Signal Contact Dia.	"D" DIM.
.040	.055 MIN.
.030	.045 MIN.
.024	.040 MIN.

Viewed from component side of PCB.
Male footprint shown.
Female footprint is mirrored.

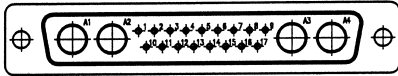

21WA4

Straight Coax Contacts

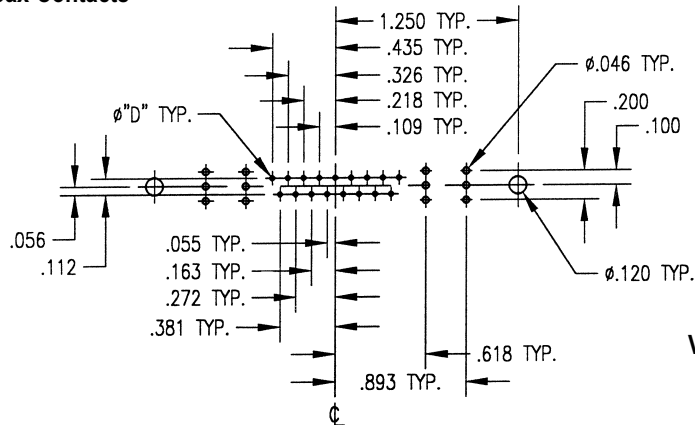

Signal Contact Dia.	"D" DIM.
.040	.055 MIN.
.030	.045 MIN.
.024	.040 MIN.

Viewed from component side of PCB.
Male footprint shown.
Female footprint is mirrored.

Dimensions shown are in inches.

D-SUBMINIATURE CONNECTORS: Footprints

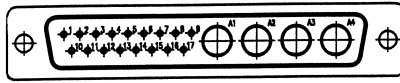

21W4
Straight Coax Contacts

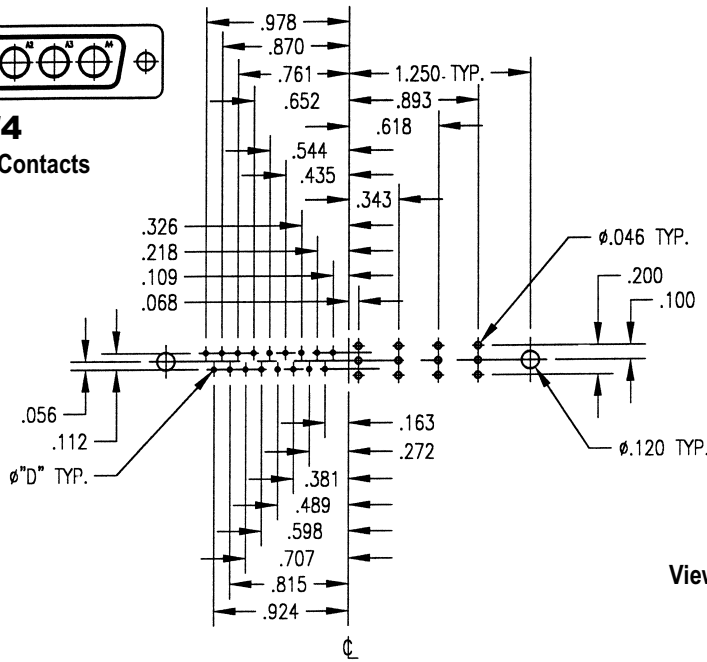

Signal Contact Dia.	"D" DIM.
.040	.055 MIN.
.030	.045 MIN.
.024	.040 MIN.

Viewed from component side of PCB.
Male footprint shown.
Female footprint is mirrored.

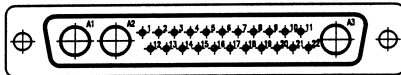

25W3
Straight Coax Contacts

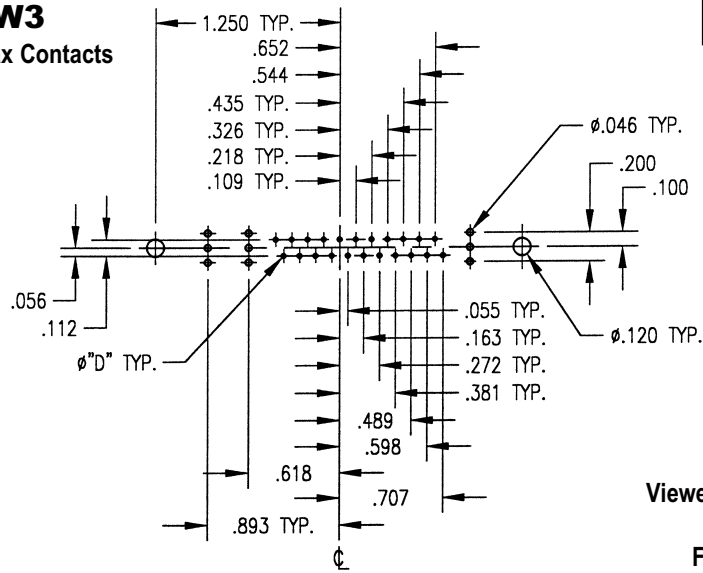

Signal Contact Dia.	"D" DIM.
.040	.055 MIN.
.030	.045 MIN.
.024	.040 MIN.

Viewed from component side of PCB.
Male footprint shown.
Female footprint is mirrored.

Dimensions shown are in inches.

D-SUBMINIATURE CONNECTORS: Footprints



27W2
Straight Coax Contacts

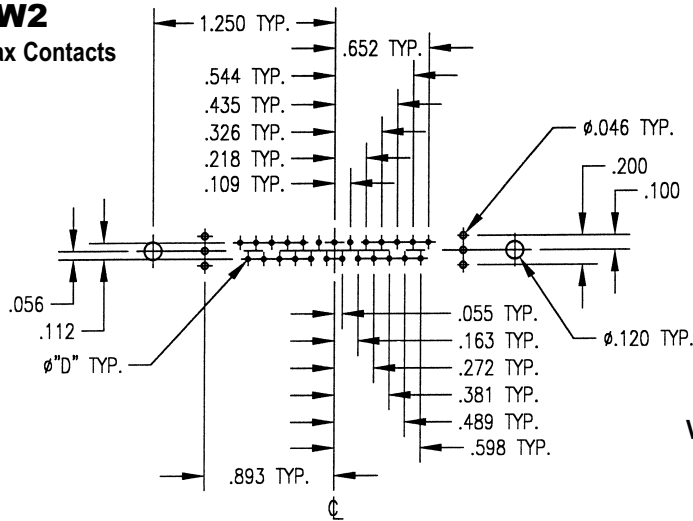

Signal Contact Dia.	"D" DIM.
.040	.055 MIN.
.030	.045 MIN.
.024	.040 MIN.

Viewed from component side of PCB.
Male footprint shown.
Female footprint is mirrored.

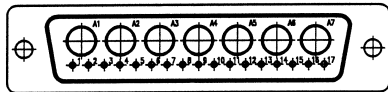

24W7
Straight Coax Contacts

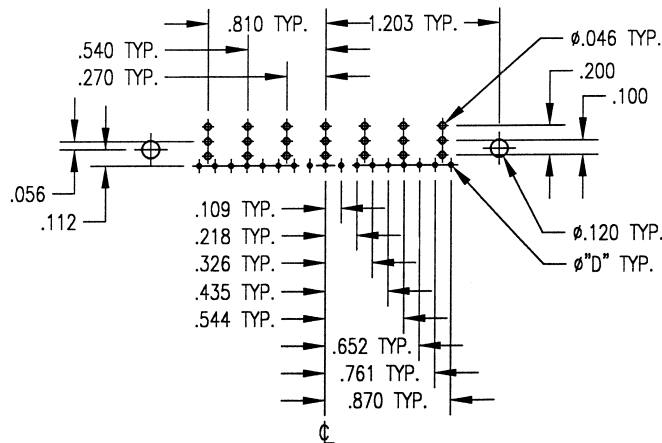

Signal Contact Dia.	"D" DIM.
.040	.055 MIN.
.030	.045 MIN.
.024	.040 MIN.

Viewed from component side of PCB.
Male footprint shown.
Female footprint is mirrored.

Dimensions shown are in inches.

D-SUBMINIATURE CONNECTORS: Footprints

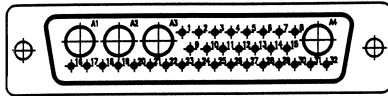

36W4

Straight Coax Contacts

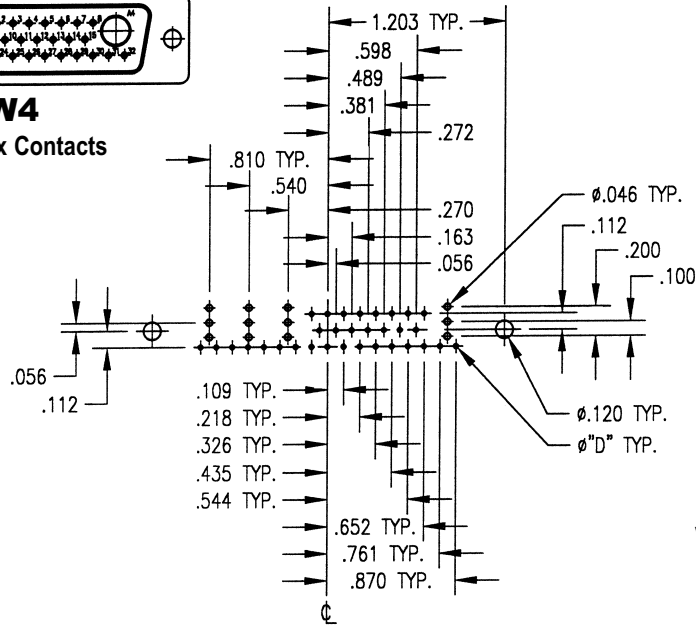

Signal Contact Dia. "D" DIM.	
.040	.055 MIN.
.030	.045 MIN.
.024	.040 MIN.

Viewed from component side of PCB.
Male footprint shown.
Female footprint is mirrored.

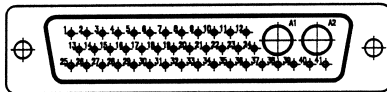

43W2

Straight Coax Contacts

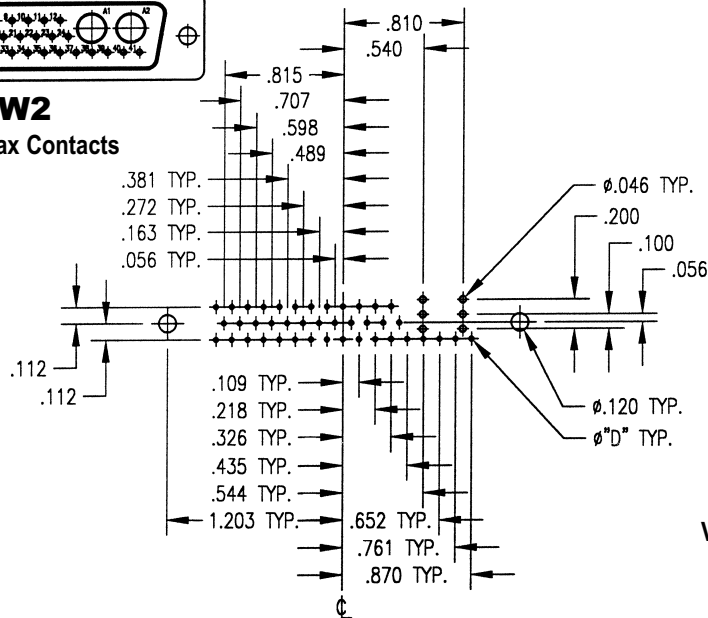

Signal Contact Dia. "D" DIM.	
.040	.055 MIN.
.030	.045 MIN.
.024	.040 MIN.

Viewed from component side of PCB.
Male footprint shown.
Female footprint is mirrored.

Dimensions shown are in inches.

D-SUBMINIATURE CONNECTORS: Footprints

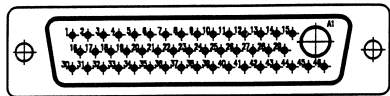

47W1
Straight Coax Contacts

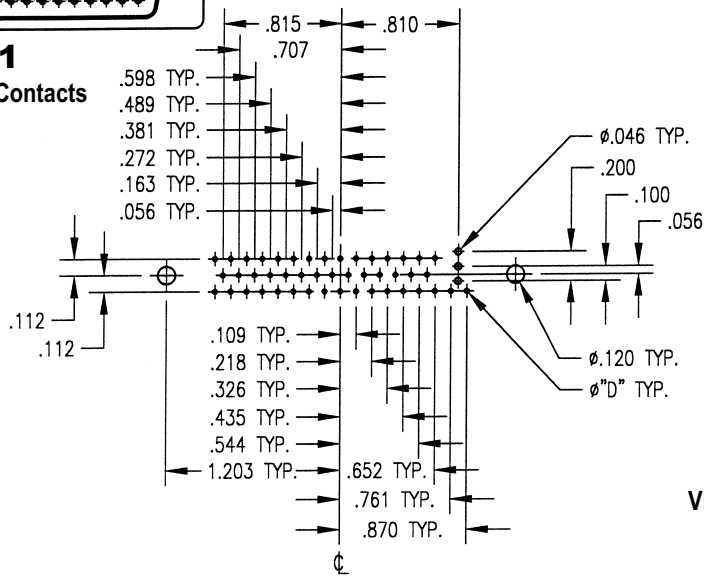

Signal Contact Dia.	"D" DIM.
.040	.055 MIN.
.030	.045 MIN.
.024	.040 MIN.

Viewed from component side of PCB.
Male footprint shown.
Female footprint is mirrored.

Dimensions shown are in inches.

D-SUBMINIATURE CONNECTORS: Footprints

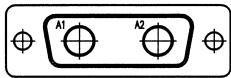

2W2
Right Angle Coax Contacts

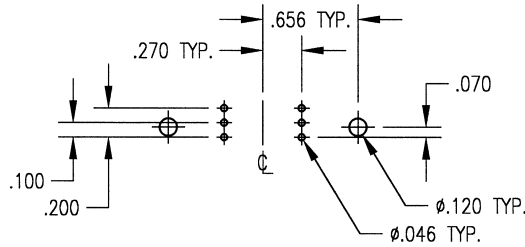

Mating Face
of Connector



Viewed from component side of PCB.
Male footprint shown.
Female footprint is mirrored.

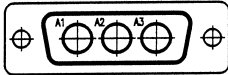

3W3
Right Angle Coax Contacts

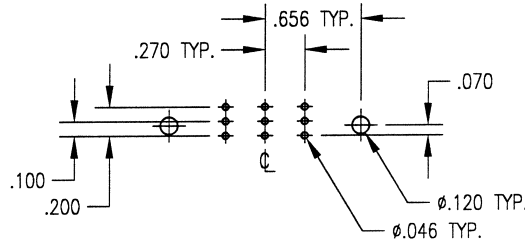

Mating Face
of Connector



Viewed from component side of PCB.
Male footprint shown.
Female footprint is mirrored.

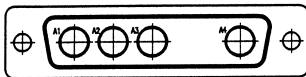

4W4
Right Angle Coax Contacts

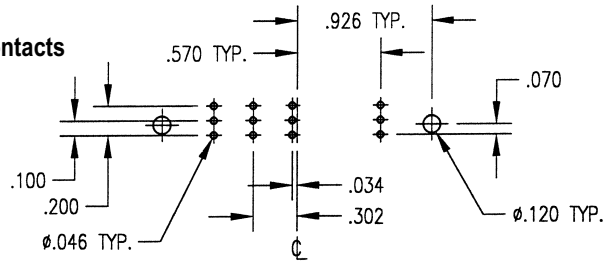

Mating Face
of Connector



Viewed from component side of PCB.
Male footprint shown.
Female footprint is mirrored.

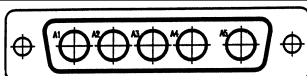

5W5
Right Angle Coax Contacts

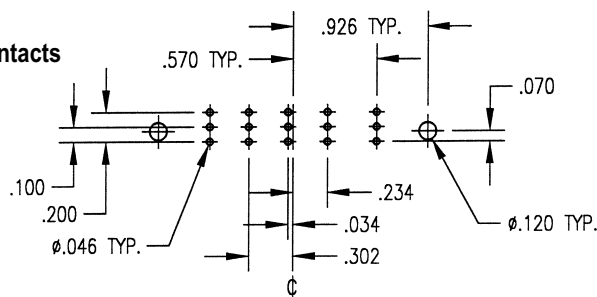

Mating Face
of Connector



Viewed from component side of PCB.
Male footprint shown.
Female footprint is mirrored.

Dimensions shown are in inches.

D-SUBMINIATURE CONNECTOR: Footprints

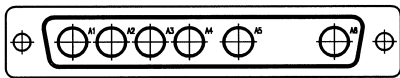

6W6

Right Angle Coax Contacts

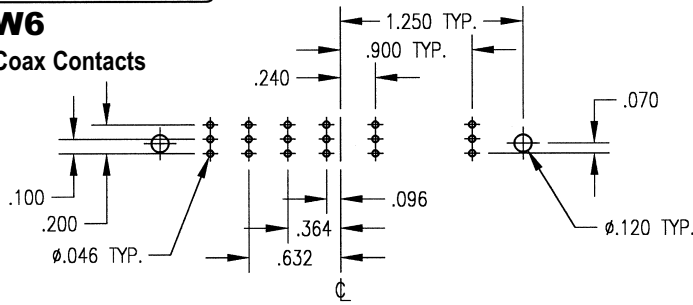

Mating Face of Connector



Viewed from component side of PCB.
Male footprint shown.
Female footprint is mirrored.

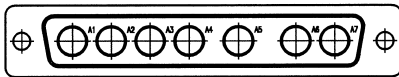

7W7

Right Angle Coax Contacts

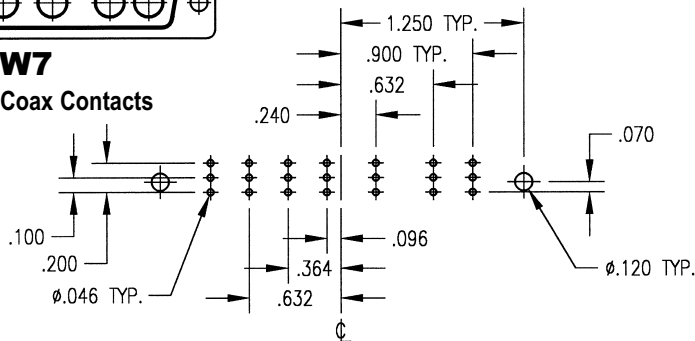

Mating Face of Connector



Viewed from component side of PCB.
Male footprint shown.
Female footprint is mirrored.



8W8

Right Angle Coax Contacts

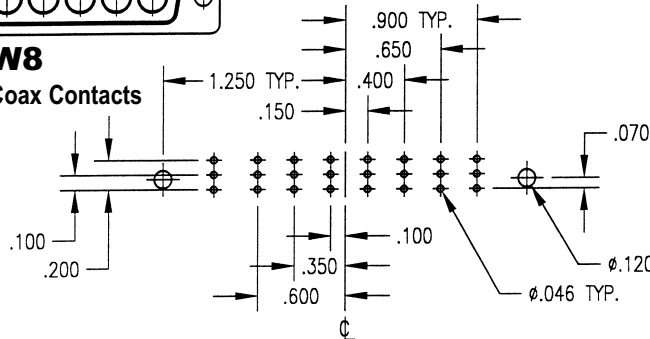

Mating Face of Connector



Viewed from component side of PCB.
Male footprint shown.
Female footprint is mirrored.

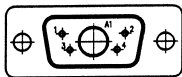

5W1

Right Angle Coax Contacts

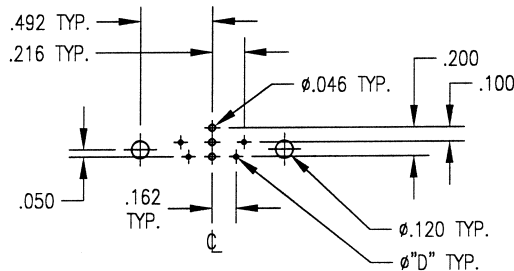

Mating Face of Connector



Signal Contact Dia. "D" DIM.	
.040	.055 MIN.
.030	.045 MIN.
.024	.040 MIN.

Viewed from component side of PCB.
Male footprint shown.
Female footprint is mirrored.

Dimensions shown are in inches.

Winchester/Retconn

D-SUBMINIATURE CONNECTORS: Footprints



7W2
Right Angle Coax Contacts

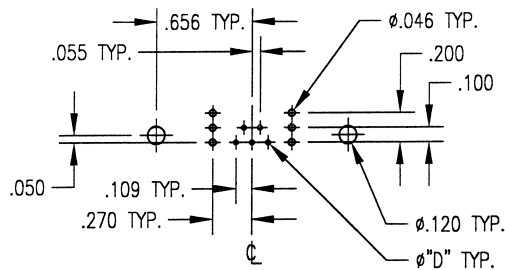

Mating Face
of Connector



Signal Contact Dia.	"D" DIM.
.040	.055 MIN.
.030	.045 MIN.
.024	.040 MIN.

Viewed from component side of PCB.
Male footprint shown.
Female footprint is mirrored.



11W1
Right Angle Coax Contacts

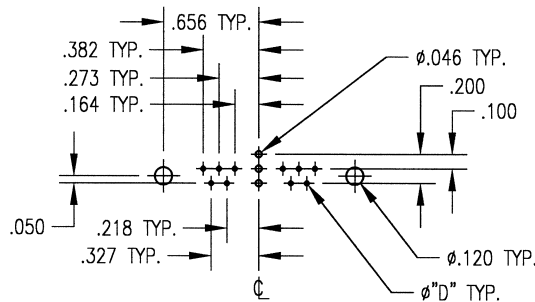

Mating Face
of Connector



Signal Contact Dia.	"D" DIM.
.040	.055 MIN.
.030	.045 MIN.
.024	.040 MIN.

Viewed from component side of PCB.
Male footprint shown.
Female footprint is mirrored.

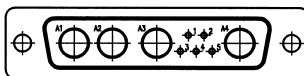

9W4
Right Angle Coax Contacts

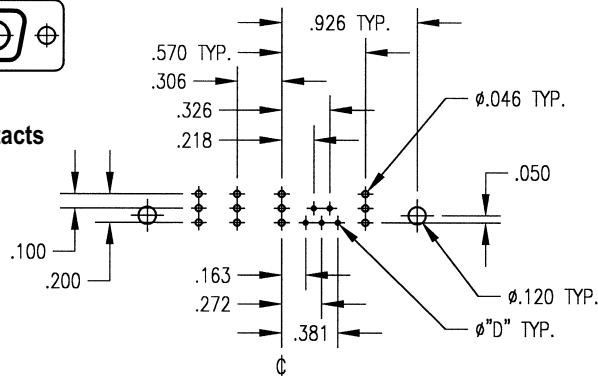

Mating Face
of Connector



Signal Contact Dia.	"D" DIM.
.040	.055 MIN.
.030	.045 MIN.
.024	.040 MIN.

Viewed from component side of PCB.
Male footprint shown.
Female footprint is mirrored.

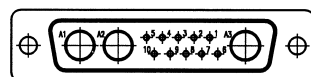

13W3
Right Angle Coax Contacts

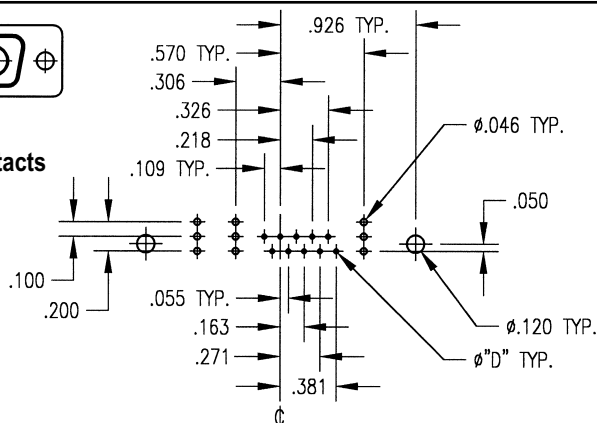

Mating Face
of Connector



Signal Contact Dia.	"D" DIM.
.040	.055 MIN.
.030	.045 MIN.
.024	.040 MIN.

Viewed from component side of PCB.
Male footprint shown.
Female footprint is mirrored.

Dimensions shown are in inches.

Winchester/Retconn

D-SUBMINIATURE CONNECTORS: Footprints



17W2
Right Angle Coax Contacts

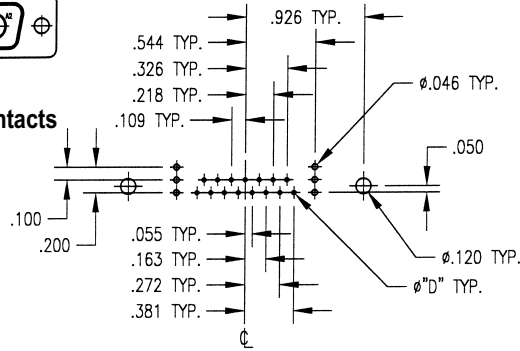

Mating Face
of Connector



Signal Contact Dia. "D" DIM.	
.040	.055 MIN.
.030	.045 MIN.
.024	.040 MIN.

Viewed from component side of PCB.
Male footprint shown.
Female footprint is mirrored.



21W1
Right Angle Coax Contacts

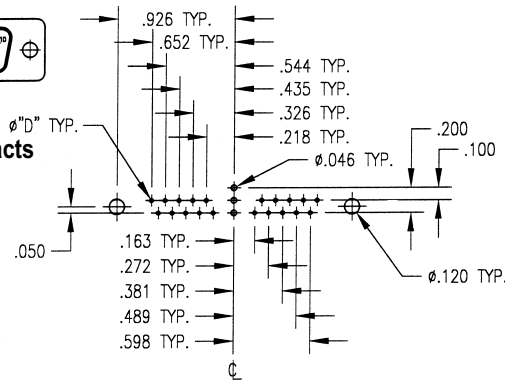

Mating Face
of Connector



Signal Contact Dia. "D" DIM.	
.040	.055 MIN.
.030	.045 MIN.
.024	.040 MIN.

Viewed from component side of PCB.
Male footprint shown.
Female footprint is mirrored.

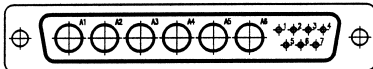

13W6
Right Angle Coax Contacts

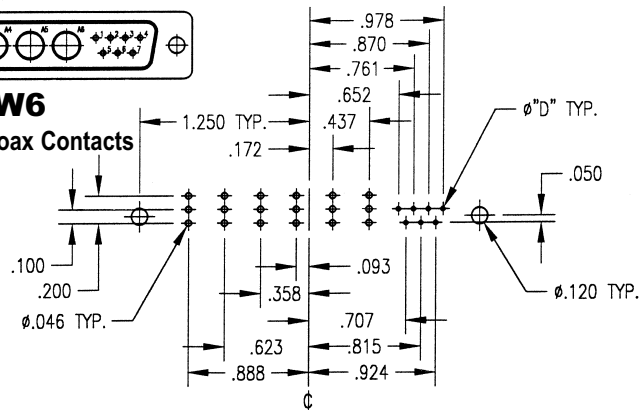

Mating Face
of Connector



Signal Contact Dia. "D" DIM.	
.040	.055 MIN.
.030	.045 MIN.
.024	.040 MIN.

Viewed from component side of PCB.
Male footprint shown.
Female footprint is mirrored.

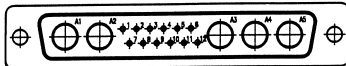

17W5
Right Angle Coax Contacts

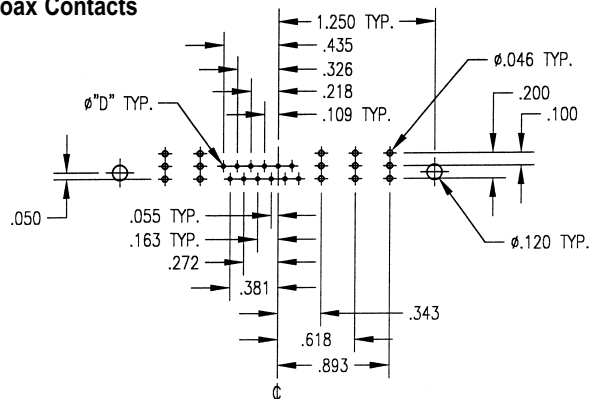

Mating Face
of Connector



Signal Contact Dia. "D" DIM.	
.040	.055 MIN.
.030	.045 MIN.
.024	.040 MIN.

Viewed from component side of PCB.
Male footprint shown.
Female footprint is mirrored.

D-SUBMINIATURE CONNECTORS: Footprints



21WA4
Right Angle Coax Contacts

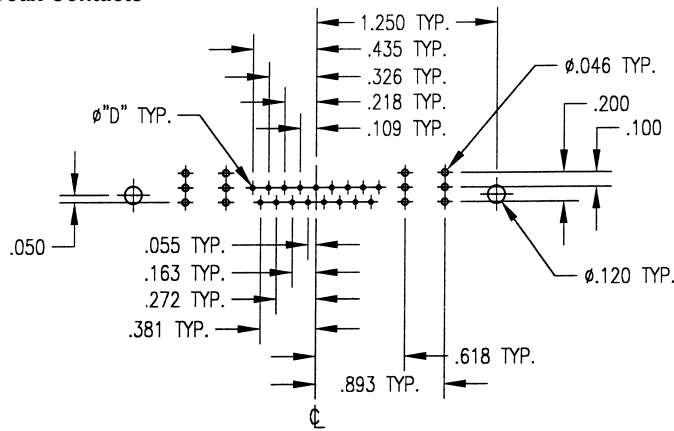

Signal Contact Dia.	"D" DIM.
.040	.055 MIN.
.030	.045 MIN.
.024	.040 MIN.

Viewed from component side of PCB.
Male footprint shown.
Female footprint is mirrored.

Mating Face
of Connector
↓

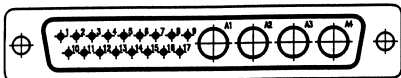

21W4
Right Angle Coax Contacts

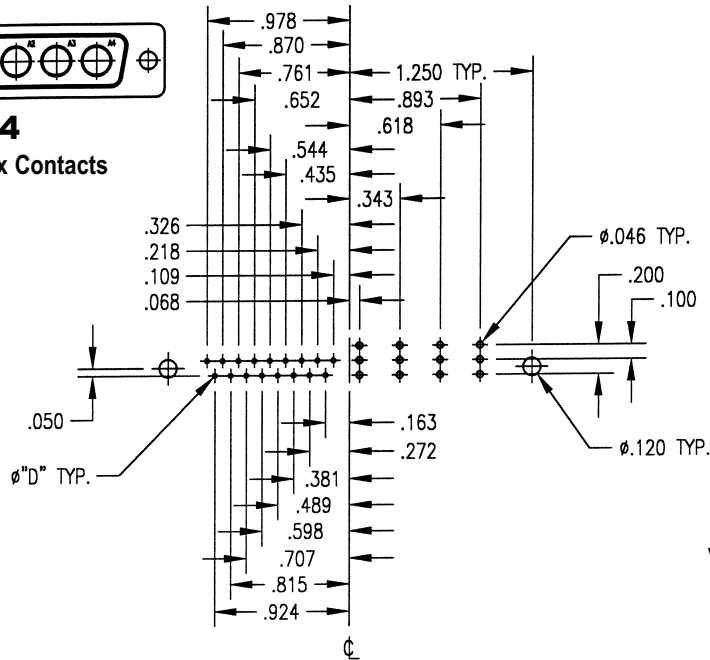

Signal Contact Dia.	"D" DIM.
.040	.055 MIN.
.030	.045 MIN.
.024	.040 MIN.

Viewed from component side of PCB.
Male footprint shown.
Female footprint is mirrored.

Mating Face
of Connector
↓

Dimensions shown are in inches.

D-SUBMINIATURE CONNECTORS: Footprints

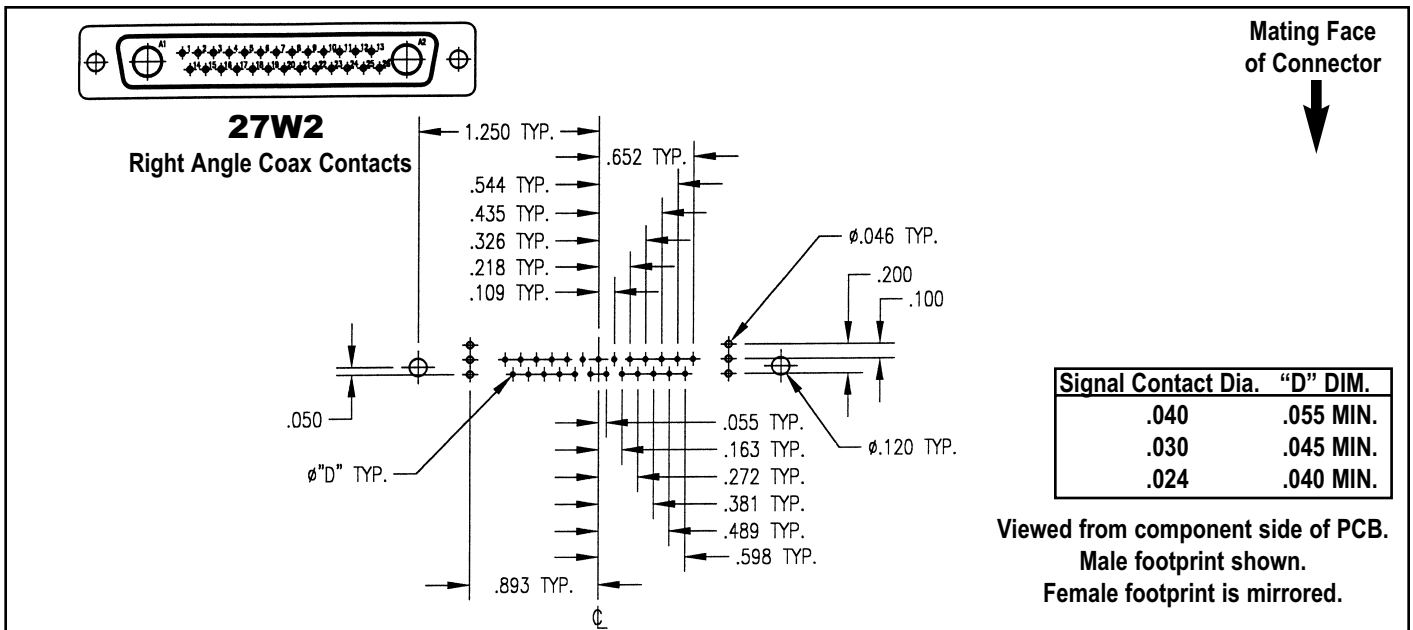
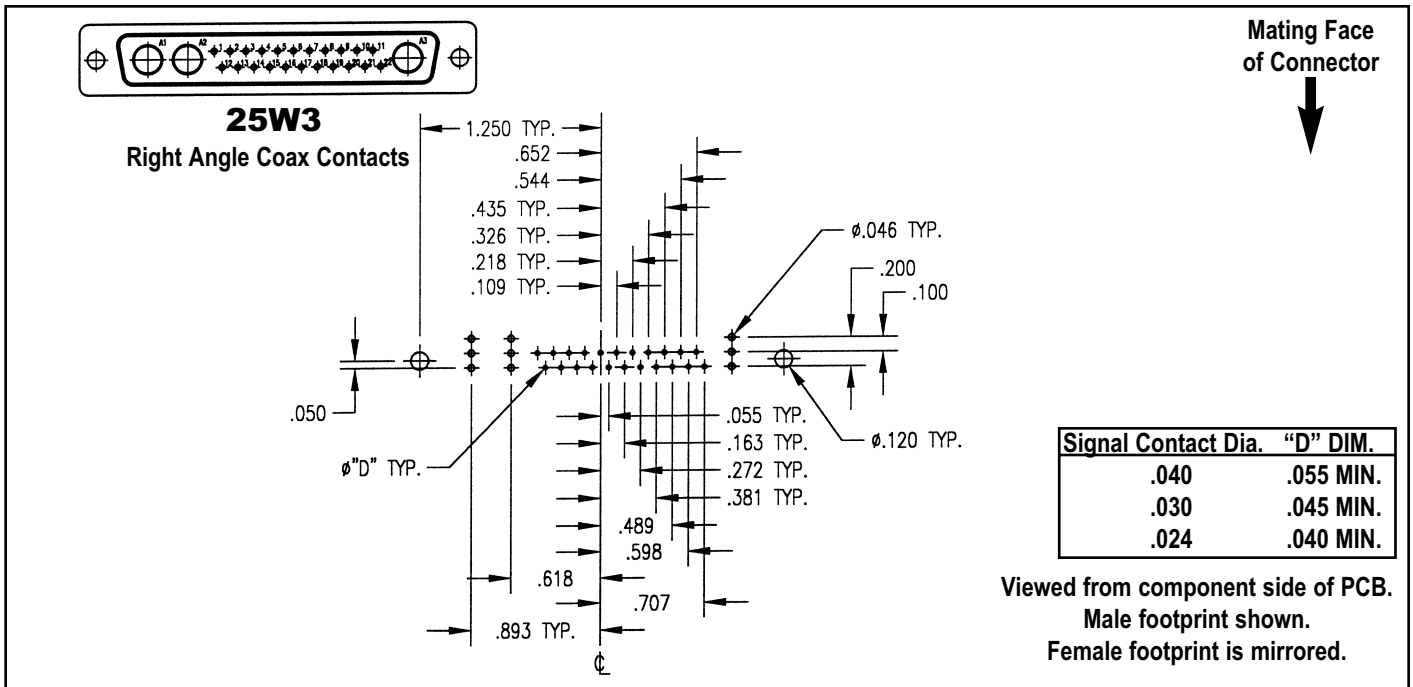

Dimensions shown are in inches.

D-SUBMINIATURE CONNECTORS: Footprints

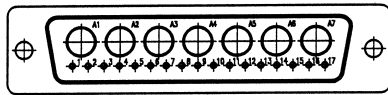

24W7
Right Angle Coax Contacts

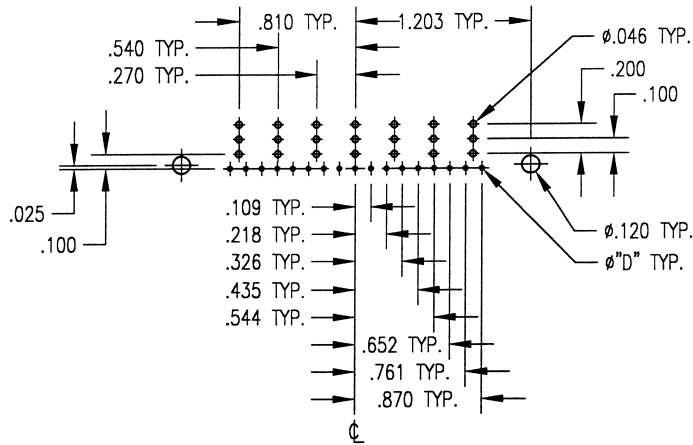

Signal Contact Dia. "D" DIM.	
.040	.055 MIN.
.030	.045 MIN.
.024	.040 MIN.

Viewed from component side of PCB.
Male footprint shown.
Female footprint is mirrored.

Mating Face
of Connector
↓



36W4
Right Angle Coax Contacts

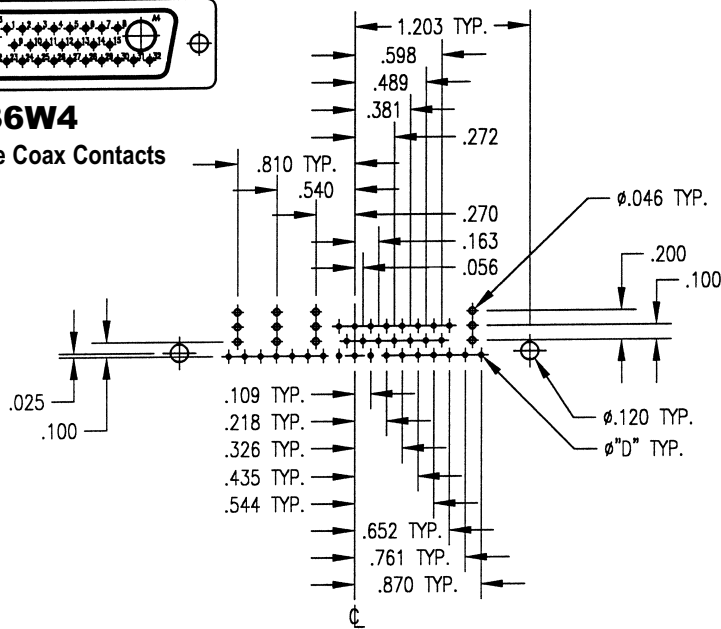

Signal Contact Dia. "D" DIM.	
.040	.055 MIN.
.030	.045 MIN.
.024	.040 MIN.

Viewed from component side of PCB.
Male footprint shown.
Female footprint is mirrored.

Mating Face
of Connector
↓

Dimensions shown are in inches.

D-SUBMINIATURE CONNECTORS: Footprints

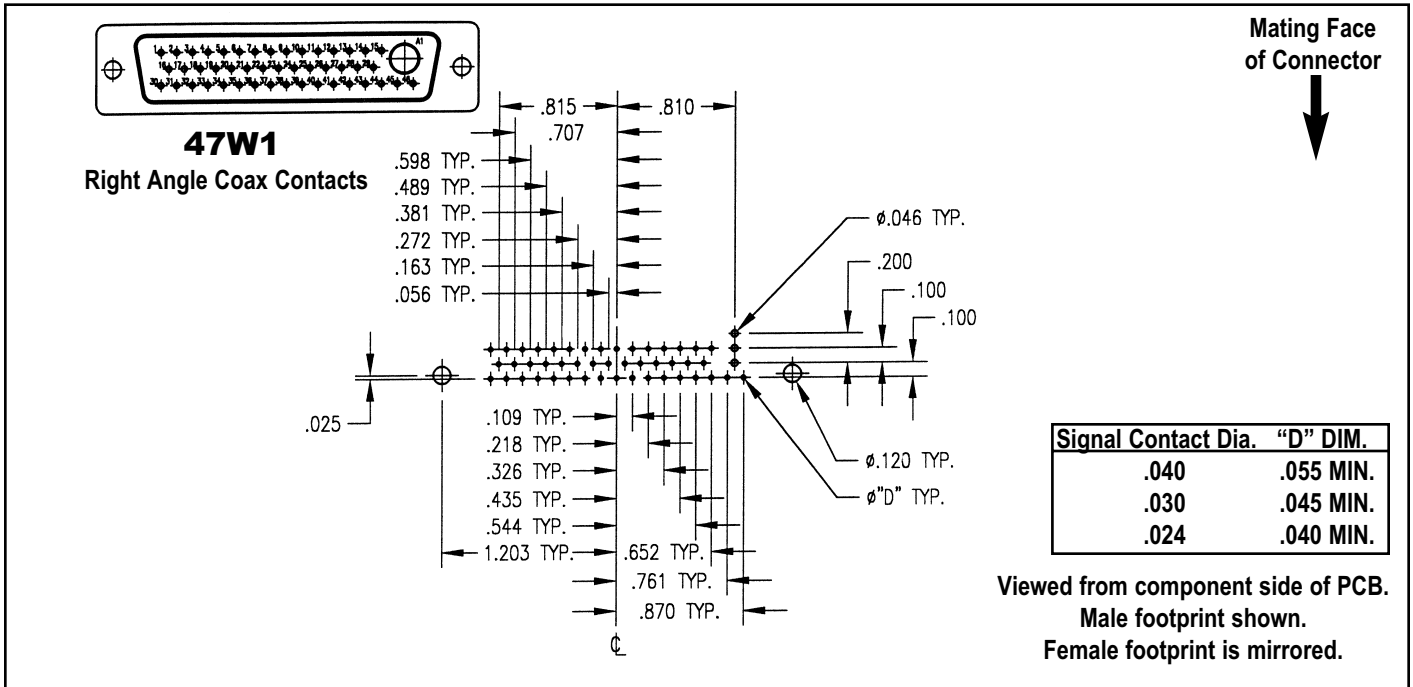
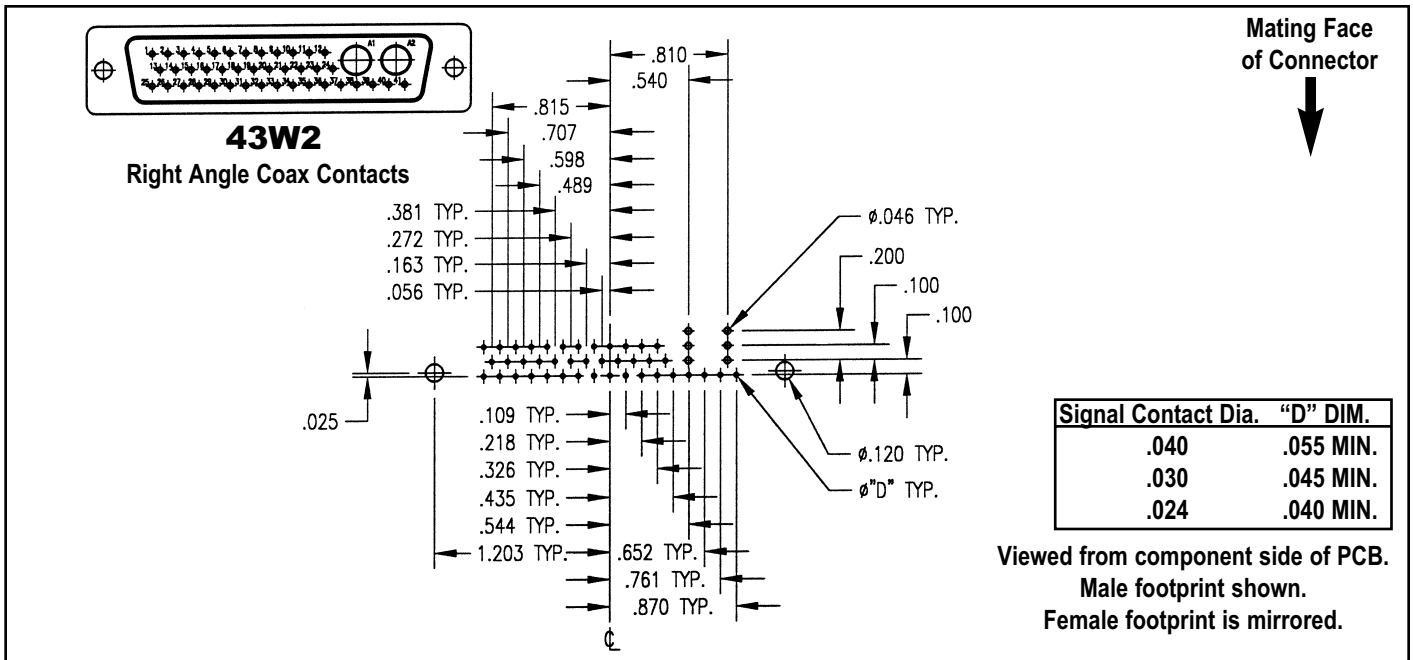

Dimensions shown are in inches.

D-SUBMINIATURE CONNECTORS: Footprints

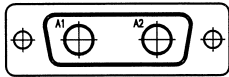

2W2

Straight Power Contacts

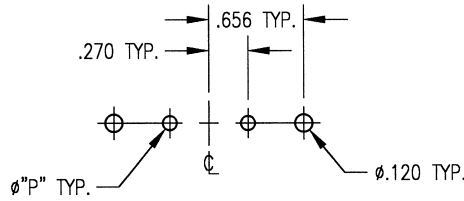

Power Contact Dia. "P" DIM.	
.125	.144 MIN.
.078	.098 MIN.

Viewed from component side of PCB.
Male footprint shown.
Female footprint is mirrored.

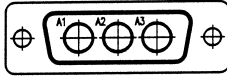

3W3

Straight Power Contacts

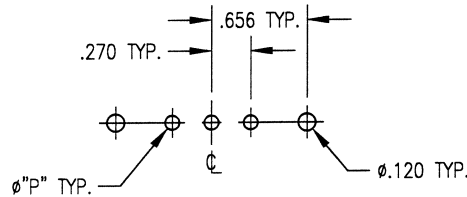

Power Contact Dia. "P" DIM.	
.125	.144 MIN.
.078	.098 MIN.

Viewed from component side of PCB.
Male footprint shown.
Female footprint is mirrored.

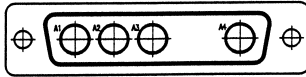

4W4

Straight Power Contacts

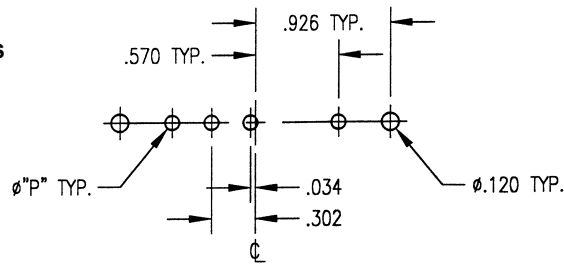

Power Contact Dia. "P" DIM.	
.125	.144 MIN.
.078	.098 MIN.

Viewed from component side of PCB.
Male footprint shown.
Female footprint is mirrored.

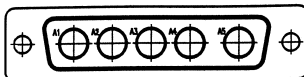

5W5

Straight Power Contacts

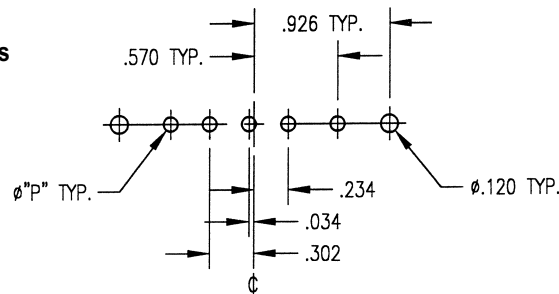

Power Contact Dia. "P" DIM.	
.125	.144 MIN.
.078	.098 MIN.

Viewed from component side of PCB.
Male footprint shown.
Female footprint is mirrored.

Dimensions shown are in inches.

D-SUBMINIATURE CONNECTORS: Footprints

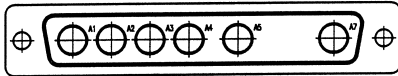

6W6
Straight Power Contacts

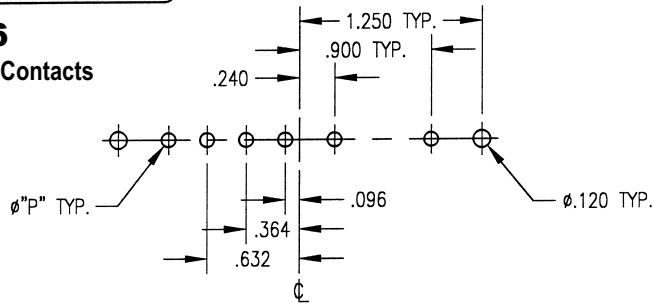

Power Contact Dia.	"P" DIM.
.125	.144 MIN.
.078	.098 MIN.

Viewed from component side of PCB.
Male footprint shown.
Female footprint is mirrored.

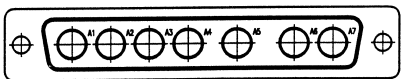

7W7
Straight Power Contacts

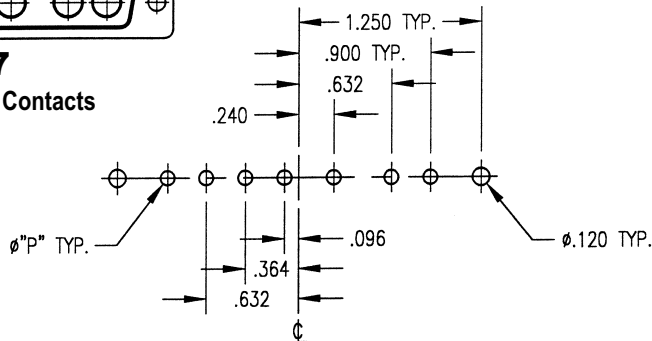

Power Contact Dia.	"P" DIM.
.125	.144 MIN.
.078	.098 MIN.

Viewed from component side of PCB.
Male footprint shown.
Female footprint is mirrored.



8W8
Straight Power Contacts

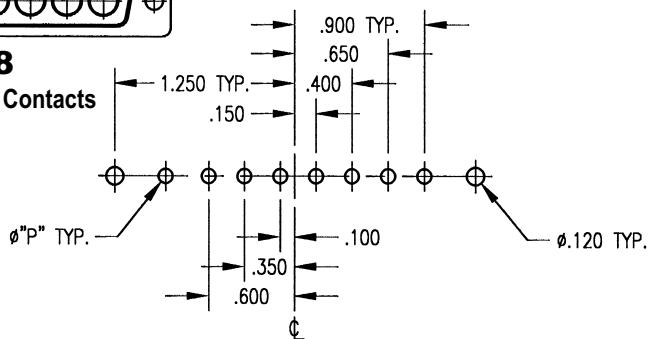

Power Contact Dia.	"P" DIM.
.125	.144 MIN.
.078	.098 MIN.

Viewed from component side of PCB.
Male footprint shown.
Female footprint is mirrored.

Dimensions shown are in inches.

D-SUBMINIATURE CONNECTORS: Footprints



5W1

Straight Power Contacts

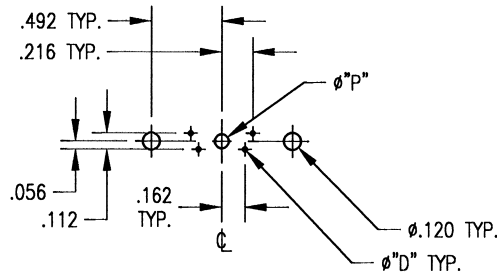

Signal Contact Dia. "D"DIM.	
.040	.055 MIN.
.030	.045 MIN.
.024	.040 MIN.

Power Contact Dia. "P"DIM.	
.125	.144 MIN.
.078	.098 MIN.

Viewed from component side of PCB.
Male footprint shown.
Female footprint is mirrored.

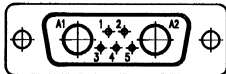

7W2

Straight Power Contacts

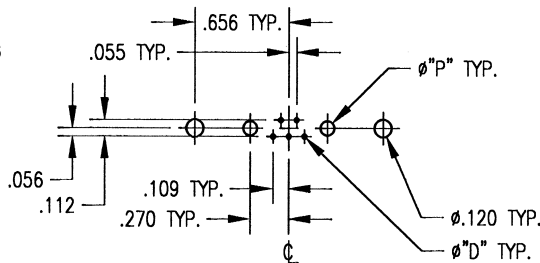

Signal Contact Dia. "D"DIM.	
.040	.055 MIN.
.030	.045 MIN.
.024	.040 MIN.

Power Contact Dia. "P"DIM.	
.125	.144 MIN.
.078	.098 MIN.

Viewed from component side of PCB.
Male footprint shown.
Female footprint is mirrored.



11W1

Straight Power Contacts

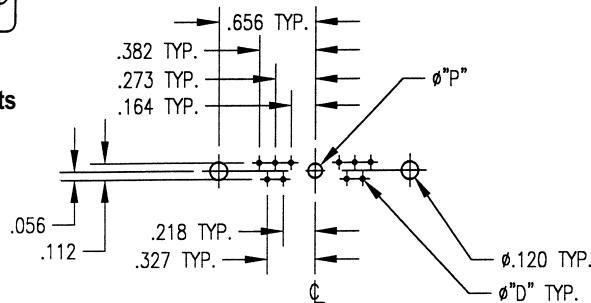

Signal Contact Dia. "D"DIM.	
.040	.055 MIN.
.030	.045 MIN.
.024	.040 MIN.

Power Contact Dia. "P"DIM.	
.125	.144 MIN.
.078	.098 MIN.

Viewed from component side of PCB.
Male footprint shown.
Female footprint is mirrored.

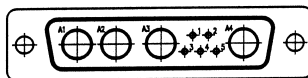

9W4

Straight Power Contacts

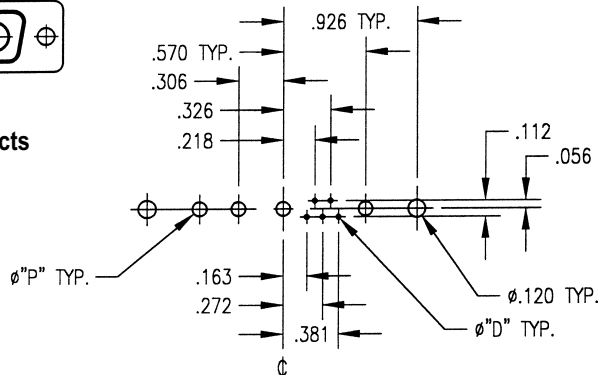

Signal Contact Dia. "D"DIM.	
.040	.055 MIN.
.030	.045 MIN.
.024	.040 MIN.

Power Contact Dia. "P"DIM.	
.125	.144 MIN.
.078	.098 MIN.

Viewed from component side of PCB.
Male footprint shown.
Female footprint is mirrored.

Dimensions shown are in inches.

Winchester/Retconn

D-SUBMINIATURE CONNECTORS: Footprints

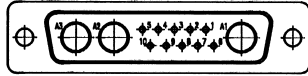

13W3
Straight Power Contacts

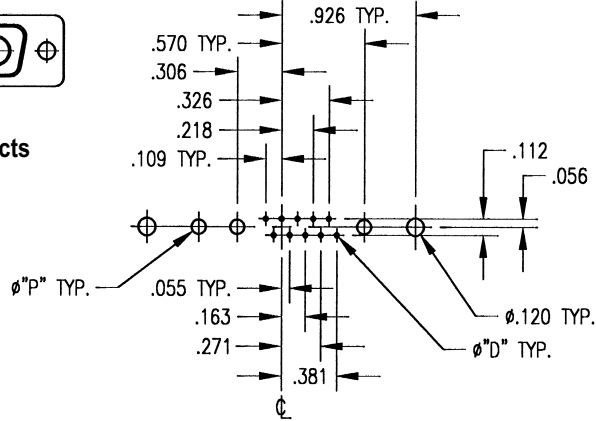

Signal Contact Dia. "D"DIM.	
.040	.055 MIN.
.030	.045 MIN.
.024	.040 MIN.

Viewed from component side of PCB.
Male footprint shown.
Female footprint is mirrored.



17W2
Straight Power Contacts

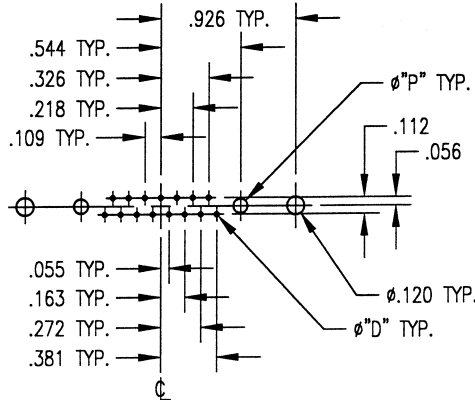

Signal Contact Dia. "D"DIM.	
.040	.055 MIN.
.030	.045 MIN.
.024	.040 MIN.

Power Contact Dia. "P"DIM.	
.125	.144 MIN.
.078	.098 MIN.

Viewed from component side of PCB.
Male footprint shown.
Female footprint is mirrored.



21W1
Straight Power Contacts

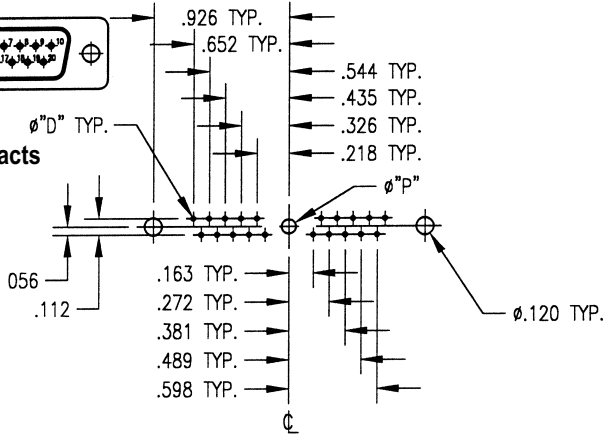

Signal Contact Dia. "D"DIM.	
.040	.055 MIN.
.030	.045 MIN.
.024	.040 MIN.

Power Contact Dia. "P"DIM.	
.125	.144 MIN.
.078	.098 MIN.

Viewed from component side of PCB.
Male footprint shown.
Female footprint is mirrored.

Dimensions shown are in inches.

D-SUBMINIATURE CONNECTORS: Footprints

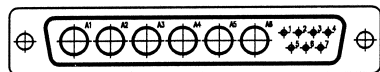

13W6
Straight Power Contacts

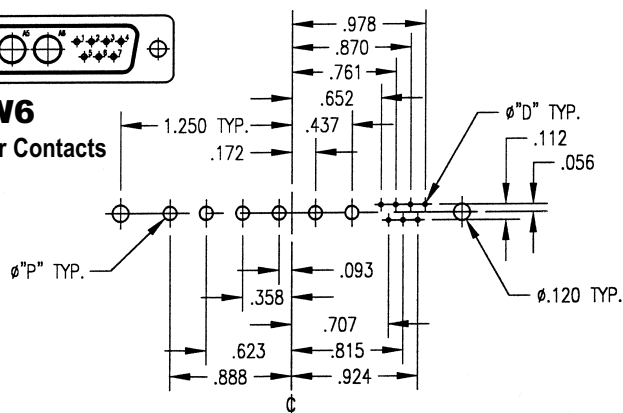

Signal Contact Dia. "D" DIM.	
.040	.055 MIN.
.030	.045 MIN.
.024	.040 MIN.

Power Contact Dia. "P" DIM.	
.125	.144 MIN.
.078	.098 MIN.

Viewed from component side of PCB.
Male footprint shown.
Female footprint is mirrored.

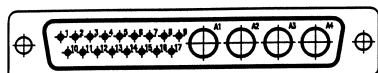

17W5
Straight Power Contacts

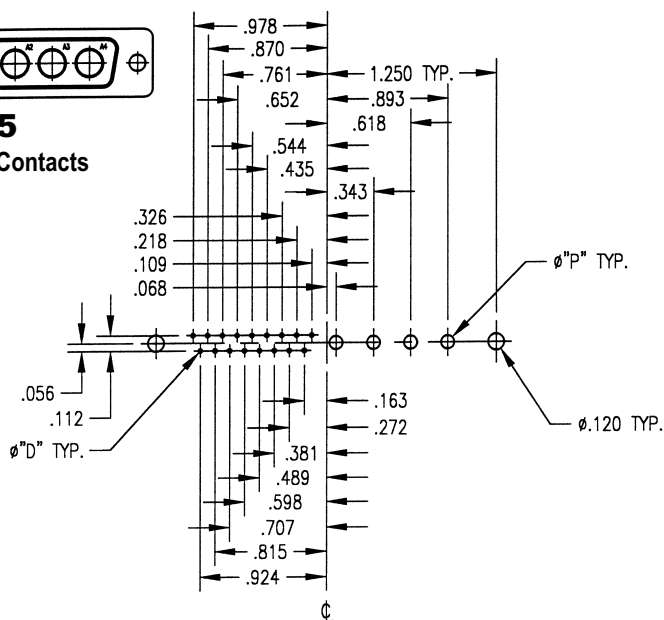

Signal Contact Dia. "D" DIM.	
.040	.055 MIN.
.030	.045 MIN.
.024	.040 MIN.

Power Contact Dia. "P" DIM.	
.125	.144 MIN.
.078	.098 MIN.

Viewed from component side of PCB.
Male footprint shown.
Female footprint is mirrored.

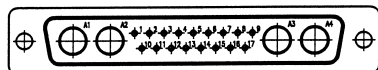

21WA4
Straight Power Contacts

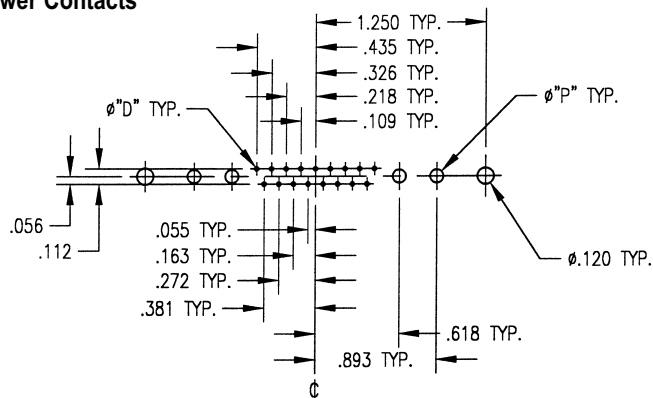

Signal Contact Dia. "D" DIM.	
.040	.055 MIN.
.030	.045 MIN.
.024	.040 MIN.

Power Contact Dia. "P" DIM.	
.125	.144 MIN.
.078	.098 MIN.

Viewed from component side of PCB.
Male footprint shown.
Female footprint is mirrored.

Dimensions shown are in inches.

Winchester/Retconn

D-SUBMINIATURE CONNECTORS: Footprints



21W4
Straight Power Contacts

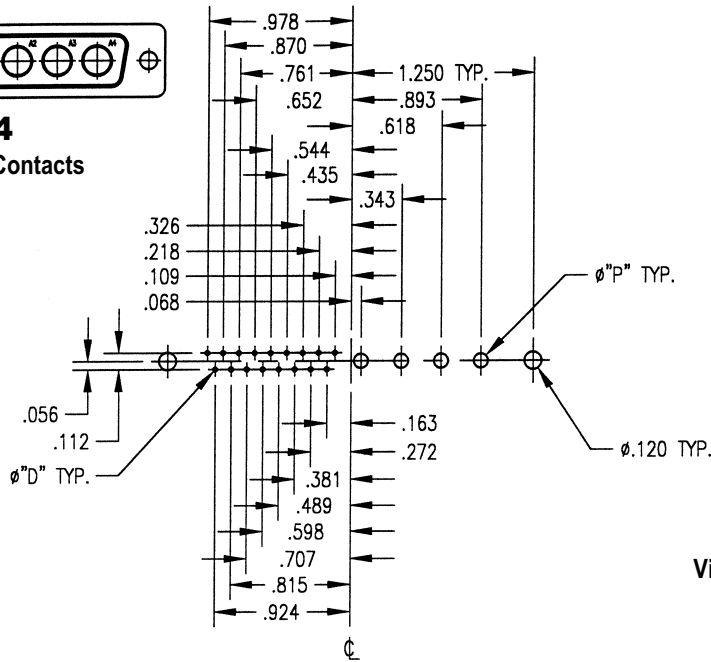

Signal Contact Dia. "D" DIM.	
.040	.055 MIN.
.030	.045 MIN.
.024	.040 MIN.

Power Contact Dia. "P" DIM.	
.125	.144 MIN.
.078	.098 MIN.

Viewed from component side of PCB.
Male footprint shown.
Female footprint is mirrored.



25W3
Straight Power Contacts

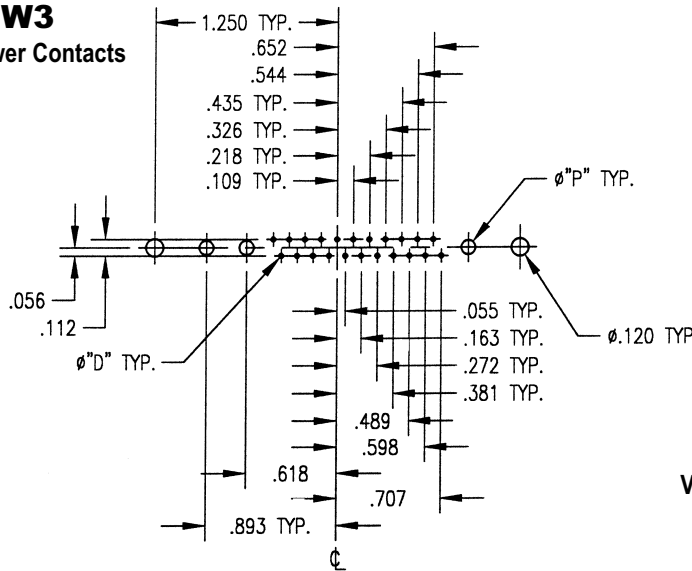

Signal Contact Dia. "D" DIM.	
.040	.055 MIN.
.030	.045 MIN.
.024	.040 MIN.

Power Contact Dia. "P" DIM.	
.125	.144 MIN.
.078	.098 MIN.

Viewed from component side of PCB.
Male footprint shown.
Female footprint is mirrored.

Dimensions shown are in inches.

D-SUBMINIATURE CONNECTORS: Footprints

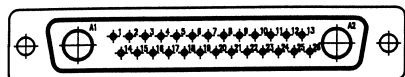

27W2
Straight Power Contacts

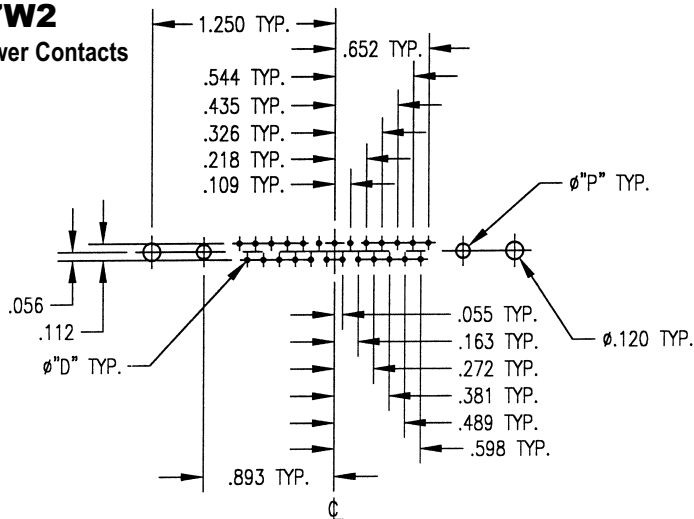

Signal Contact Dia. "D" DIM.	
.040	.055 MIN.
.030	.045 MIN.
.024	.040 MIN.

Power Contact Dia. "P" DIM.	
.125	.144 MIN.
.078	.098 MIN.

Viewed from component side of PCB.
Male footprint shown.
Female footprint is mirrored.

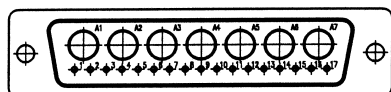

24W7
Straight Power Contacts

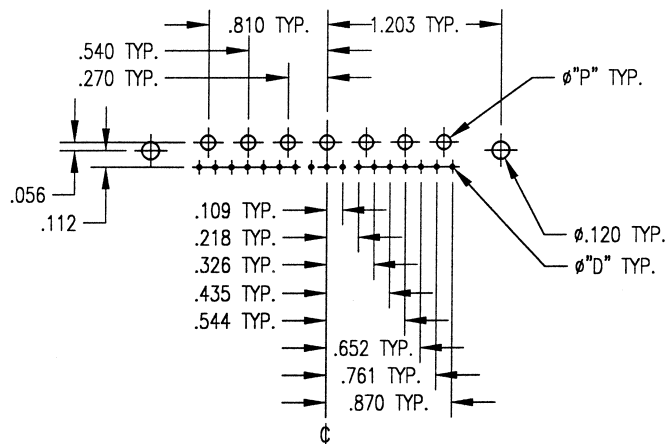

Signal Contact Dia. "D" DIM.	
.040	.055 MIN.
.030	.045 MIN.
.024	.040 MIN.

Power Contact Dia. "P" DIM.	
.125	.144 MIN.
.078	.098 MIN.

Viewed from component side of PCB.
Male footprint shown.
Female footprint is mirrored.

Dimensions shown are in inches.

D-SUBMINIATURE CONNECTORS: Footprints



36W4
Straight Power Contacts

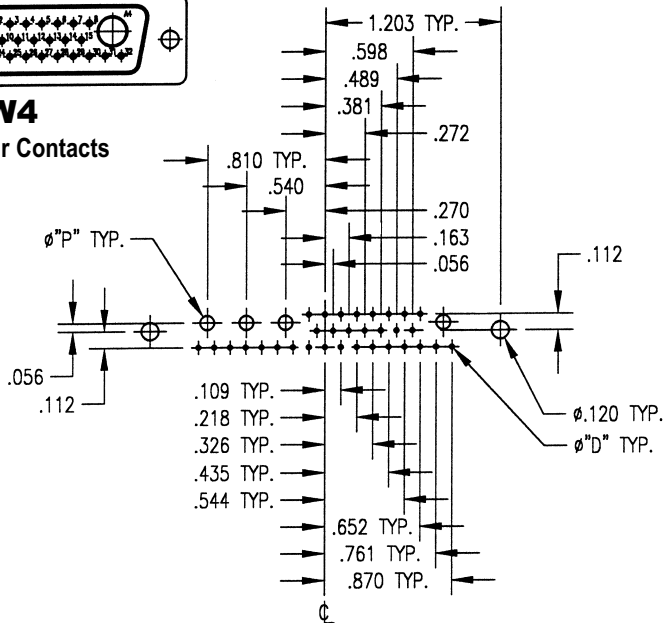

Signal Contact Dia. "D" DIM.	
.040	.055 MIN.
.030	.045 MIN.
.024	.040 MIN.

Power Contact Dia. "P" DIM.	
.125	.144 MIN.
.078	.098 MIN.

Viewed from component side of PCB.
Male footprint shown.
Female footprint is mirrored.

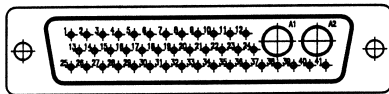

43W2
Straight Power Contacts

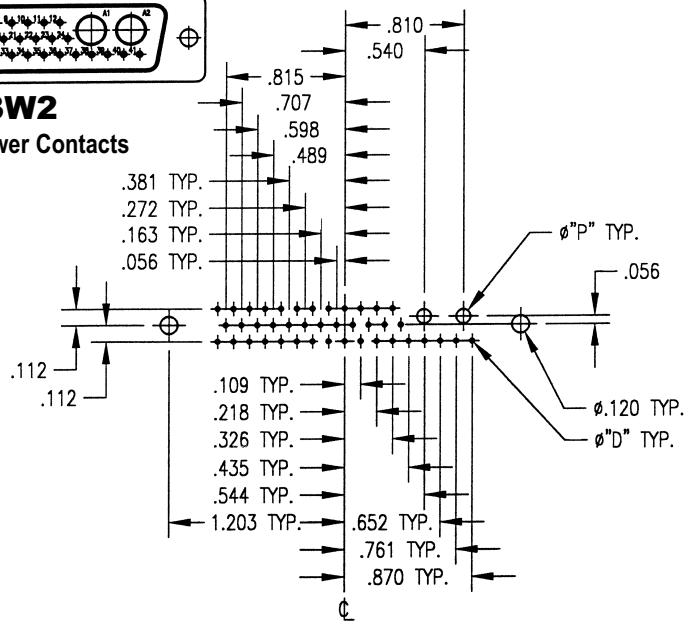

Signal Contact Dia. "D" DIM.	
.040	.055 MIN.
.030	.045 MIN.
.024	.040 MIN.

Power Contact Dia. "P" DIM.	
.125	.144 MIN.
.078	.098 MIN.

Viewed from component side of PCB.
Male footprint shown.
Female footprint is mirrored.

Dimensions shown are in inches.

D-SUBMINIATURE CONNECTORS: Footprints

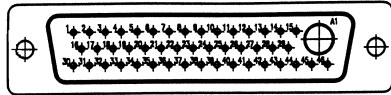

47W1

Straight Power Contacts

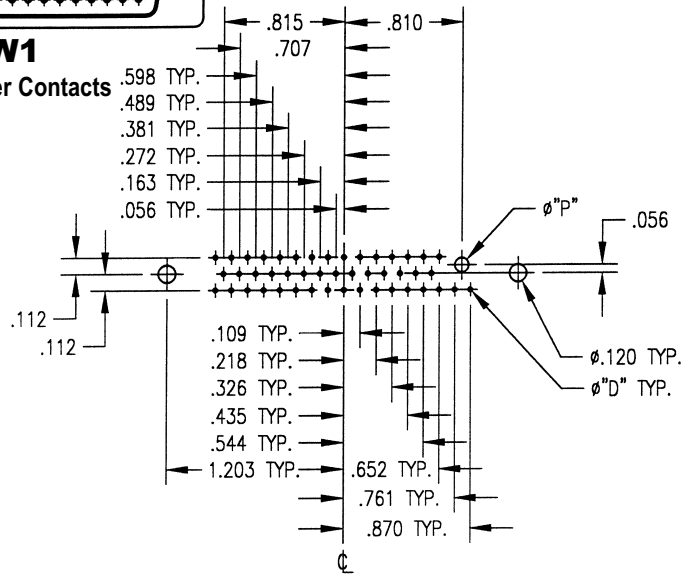

Signal Contact Dia. "D" DIM.	
.040	.055 MIN.
.030	.045 MIN.
.024	.040 MIN.

Power Contact Dia. "P" DIM.	
.125	.144 MIN.
.078	.098 MIN.

Viewed from component side of PCB.
 Male footprint shown.
 Female footprint is mirrored.

Dimensions shown are in inches.

D-SUBMINIATURE CONNECTORS: Footprints

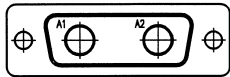

2W2

Right Angle Power Contacts

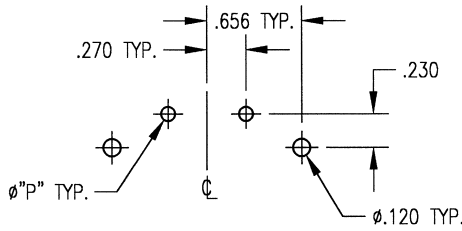

Mating Face
of Connector



Power Contact Dia. "P" DIM.	
.125	.144 MIN.
.078	.098 MIN.

Viewed from component side of PCB.
Male footprint shown.
Female footprint is mirrored.

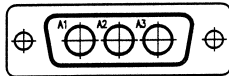

3W3

Right Angle Power Contacts

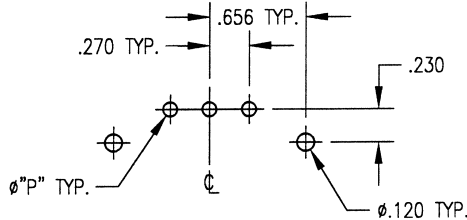

Mating Face
of Connector



Power Contact Dia. "P" DIM.	
.125	.144 MIN.
.078	.098 MIN.

Viewed from component side of PCB.
Male footprint shown.
Female footprint is mirrored.

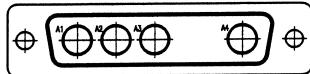

4W4

Right Angle Power Contacts

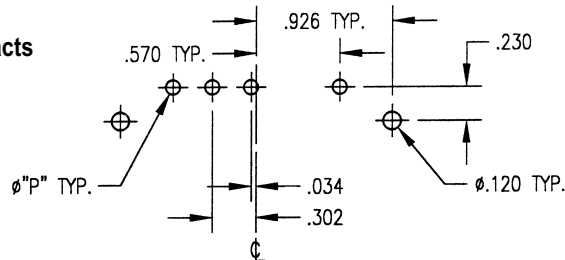

Mating Face
of Connector



Power Contact Dia. "P" DIM.	
.125	.144 MIN.
.078	.098 MIN.

Viewed from component side of PCB.
Male footprint shown.
Female footprint is mirrored.

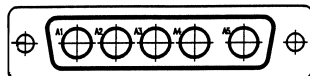

5W5

Right Angle Power Contacts

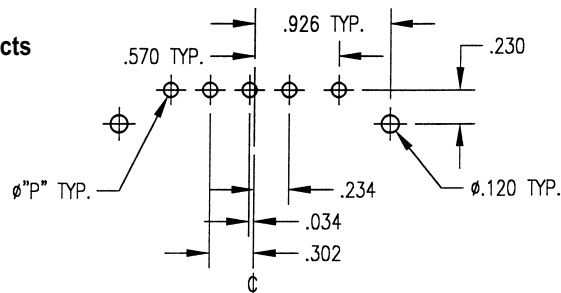

Mating Face
of Connector



Power Contact Dia. "P" DIM.	
.125	.144 MIN.
.078	.098 MIN.

Viewed from component side of PCB.
Male footprint shown.
Female footprint is mirrored.

Dimensions shown are in inches.

Winchester/Retconn

D-SUBMINIATURE CONNECTORS: Footprints

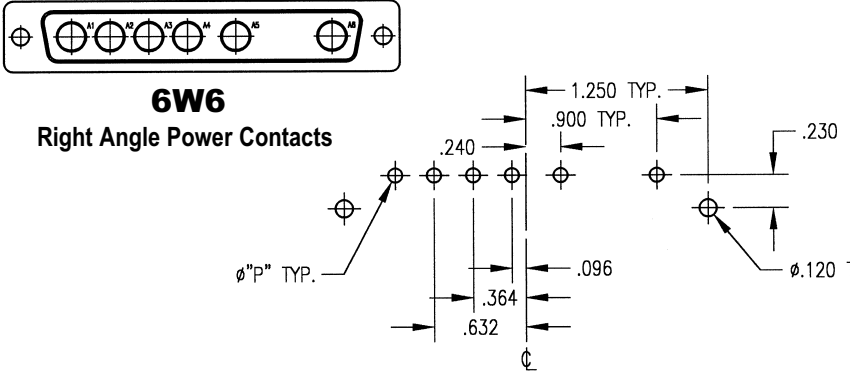

6W6
Right Angle Power Contacts

Dimensions: .240, .364, .632, .096, .900 TYP., 1.250 TYP., .230, ϕ .120 TYP., ϕ "P" TYP.

Mating Face of Connector
↓

Power Contact Dia.	"P" DIM.
.125	.144 MIN.
.078	.098 MIN.

Viewed from component side of PCB.
Male footprint shown.
Female footprint is mirrored.

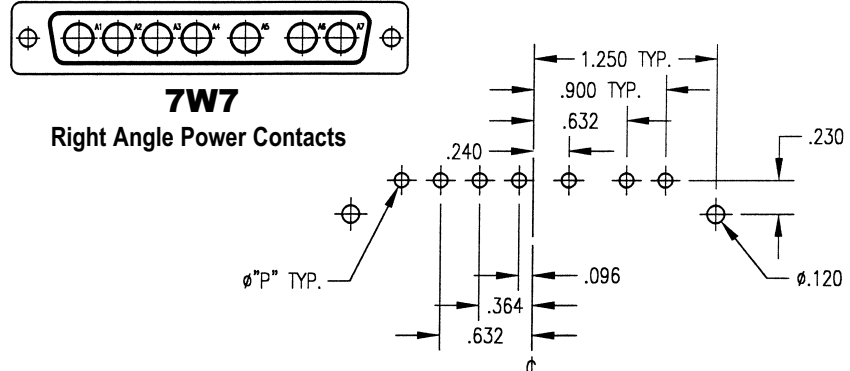

7W7
Right Angle Power Contacts

Dimensions: .240, .364, .632, .096, .900 TYP., 1.250 TYP., .230, ϕ .120 TYP., ϕ "P" TYP.

Mating Face of Connector
↓

Power Contact Dia.	"P" DIM.
.125	.144 MIN.
.078	.098 MIN.

Viewed from component side of PCB.
Male footprint shown.
Female footprint is mirrored.

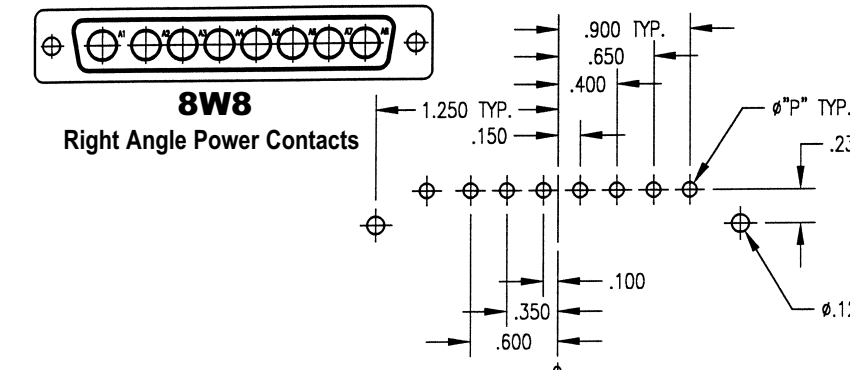

8W8
Right Angle Power Contacts

Dimensions: .150, .350, .600, .100, .400, .650, .900 TYP., 1.250 TYP., .230, ϕ .120 TYP., ϕ "P" TYP.

Mating Face of Connector
↓

Power Contact Dia.	"P" DIM.
.125	.144 MIN.
.078	.098 MIN.

Viewed from component side of PCB.
Male footprint shown.
Female footprint is mirrored.

Dimensions shown are in inches.

D-SUBMINIATURE CONNECTORS: Footprints

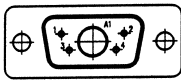

5W1

Right Angle Power Contacts

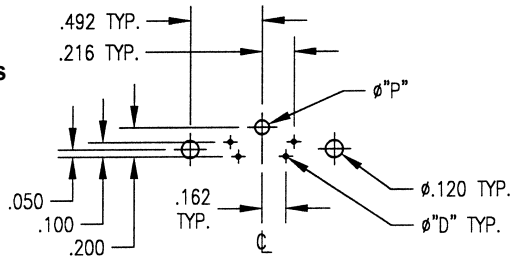

Mating Face
of Connector

Signal Contact Dia. "D" DIM.	
.040	.055 MIN.
.030	.045 MIN.
.024	.040 MIN.

Power Contact Dia. "P" DIM.	
.125	.144 MIN.
.078	.098 MIN.

Viewed from component side of PCB.
Male footprint shown.
Female footprint is mirrored.



7W2

Right Angle Power Contacts

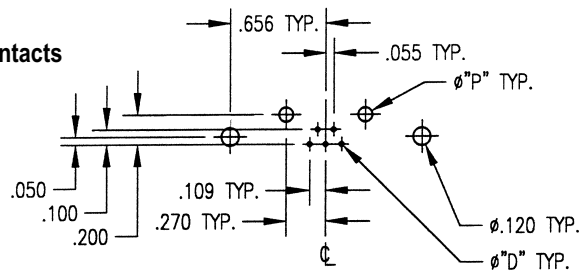

Mating Face
of Connector

Signal Contact Dia. "D" DIM.	
.040	.055 MIN.
.030	.045 MIN.
.024	.040 MIN.

Power Contact Dia. "P" DIM.	
.125	.144 MIN.
.078	.098 MIN.

Viewed from component side of PCB.
Male footprint shown.
Female footprint is mirrored.



11W1

Right Angle Power Contacts

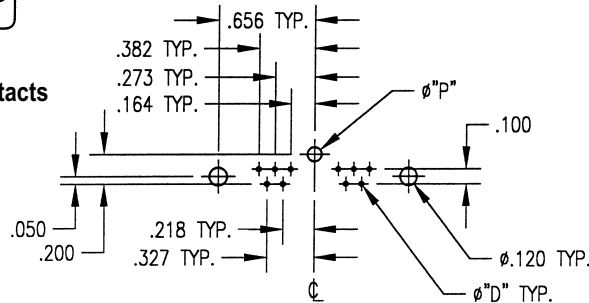

Mating Face
of Connector

Signal Contact Dia. "D" DIM.	
.040	.055 MIN.
.030	.045 MIN.
.024	.040 MIN.

Power Contact Dia. "P" DIM.	
.125	.144 MIN.
.078	.098 MIN.

Viewed from component side of PCB.
Male footprint shown.
Female footprint is mirrored.

Dimensions shown are in inches.

D-SUBMINIATURE CONNECTORS: Footprints

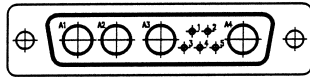

9W4
Right Angle Power Contacts

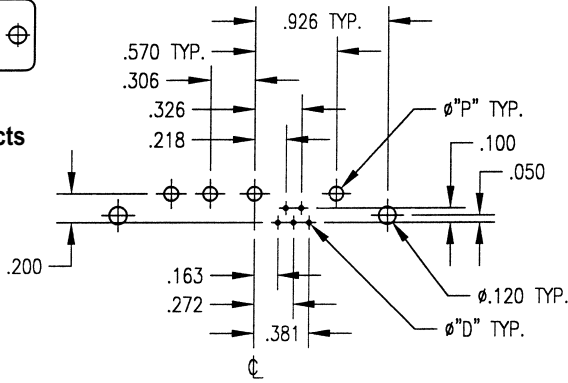

Mating Face
of Connector



Signal Contact Dia. "D" DIM.	
.040	.055 MIN.
.030	.045 MIN.
.024	.040 MIN.

Power Contact Dia. "P" DIM.	
.125	.144 MIN.
.078	.098 MIN.

Viewed from component side of PCB.
Male footprint shown.
Female footprint is mirrored.

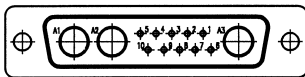

13W3
Right Angle Power Contacts

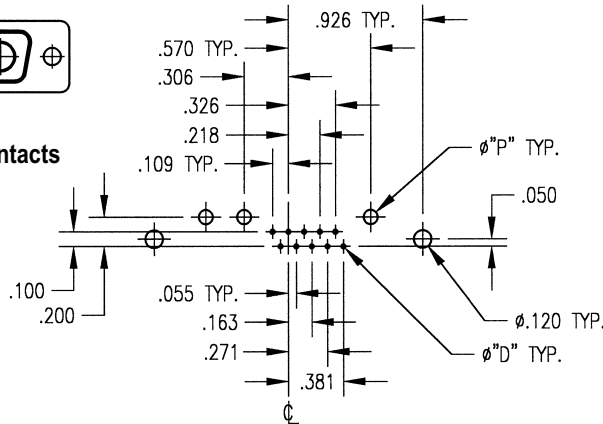

Mating Face
of Connector



Signal Contact Dia. "D" DIM.	
.040	.055 MIN.
.030	.045 MIN.
.024	.040 MIN.

Power Contact Dia. "P" DIM.	
.125	.144 MIN.
.078	.098 MIN.

Viewed from component side of PCB.
Male footprint shown.
Female footprint is mirrored.

Dimensions shown are in inches.

D-SUBMINIATURE CONNECTOR: Footprints



17W2
Right Angle Power Contacts

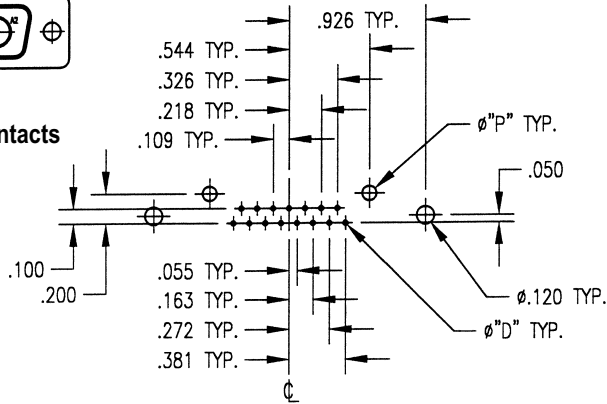

Mating Face
of Connector



Signal Contact Dia. "D" DIM.	
.040	.055 MIN.
.030	.045 MIN.
.024	.040 MIN.

Power Contact Dia. "P" DIM.	
.125	.144 MIN.
.078	.098 MIN.

Viewed from component side of PCB.
Male footprint shown.
Female footprint is mirrored.



21W1
Right Angle Power Contacts

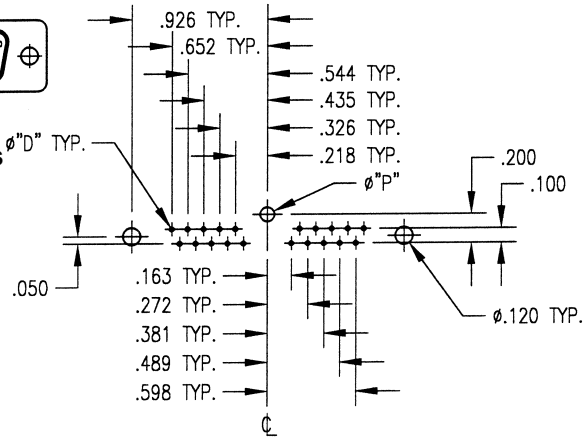

Mating Face
of Connector



Signal Contact Dia. "D" DIM.	
.040	.055 MIN.
.030	.045 MIN.
.024	.040 MIN.

Power Contact Dia. "P" DIM.	
.125	.144 MIN.
.078	.098 MIN.

Viewed from component side of PCB.
Male footprint shown.
Female footprint is mirrored.

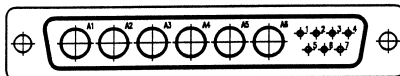

13W6
Right Angle Power Contacts

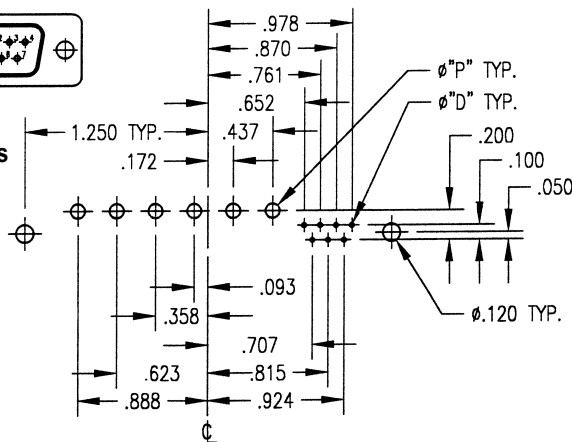

Mating Face
of Connector



Signal Contact Dia. "D" DIM.	
.040	.055 MIN.
.030	.045 MIN.
.024	.040 MIN.

Power Contact Dia. "P" DIM.	
.125	.144 MIN.
.078	.098 MIN.

Viewed from component side of PCB.
Male footprint shown.
Female footprint is mirrored.

Dimensions shown are in inches.

D-SUBMINIATURE CONNECTORS: Footprints

Mating Face
of Connector

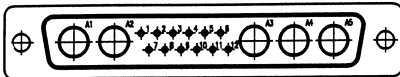

17W5

Right Angle Power Contacts

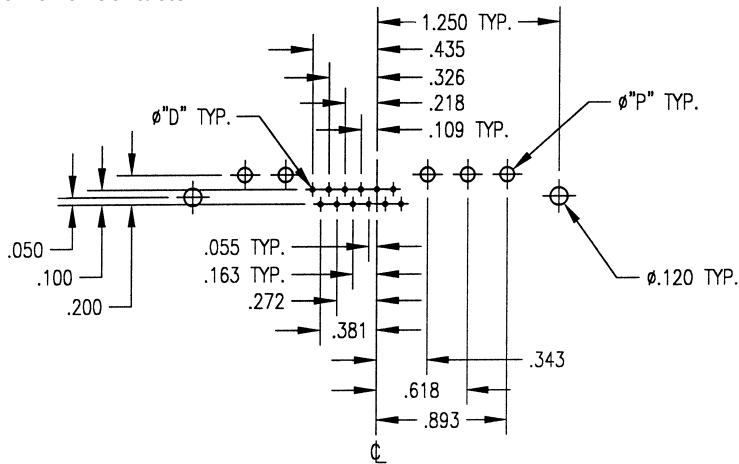

Signal Contact Dia. "D" DIM.	
.040	.055 MIN.
.030	.045 MIN.
.024	.040 MIN.

Power Contact Dia. "P" DIM.	
.125	.144 MIN.
.078	.098 MIN.

Viewed from component side of PCB.
Male footprint shown.
Female footprint is mirrored.

Mating Face
of Connector

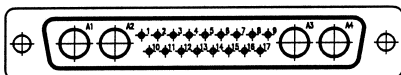

21WA4

Right Angle Power Contacts

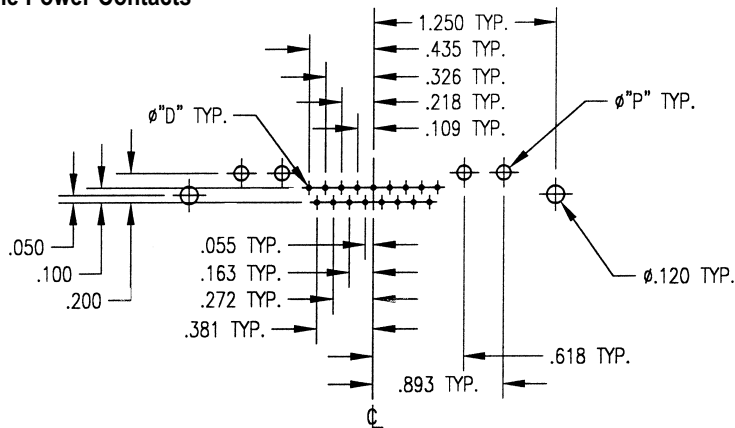

Signal Contact Dia. "D" DIM.	
.040	.055 MIN.
.030	.045 MIN.
.024	.040 MIN.

Power Contact Dia. "P" DIM.	
.125	.144 MIN.
.078	.098 MIN.

Viewed from component side of PCB.
Male footprint shown.
Female footprint is mirrored.

Dimensions shown are in inches.

D- SUBMINIATURE CONNECTORS: Footprints

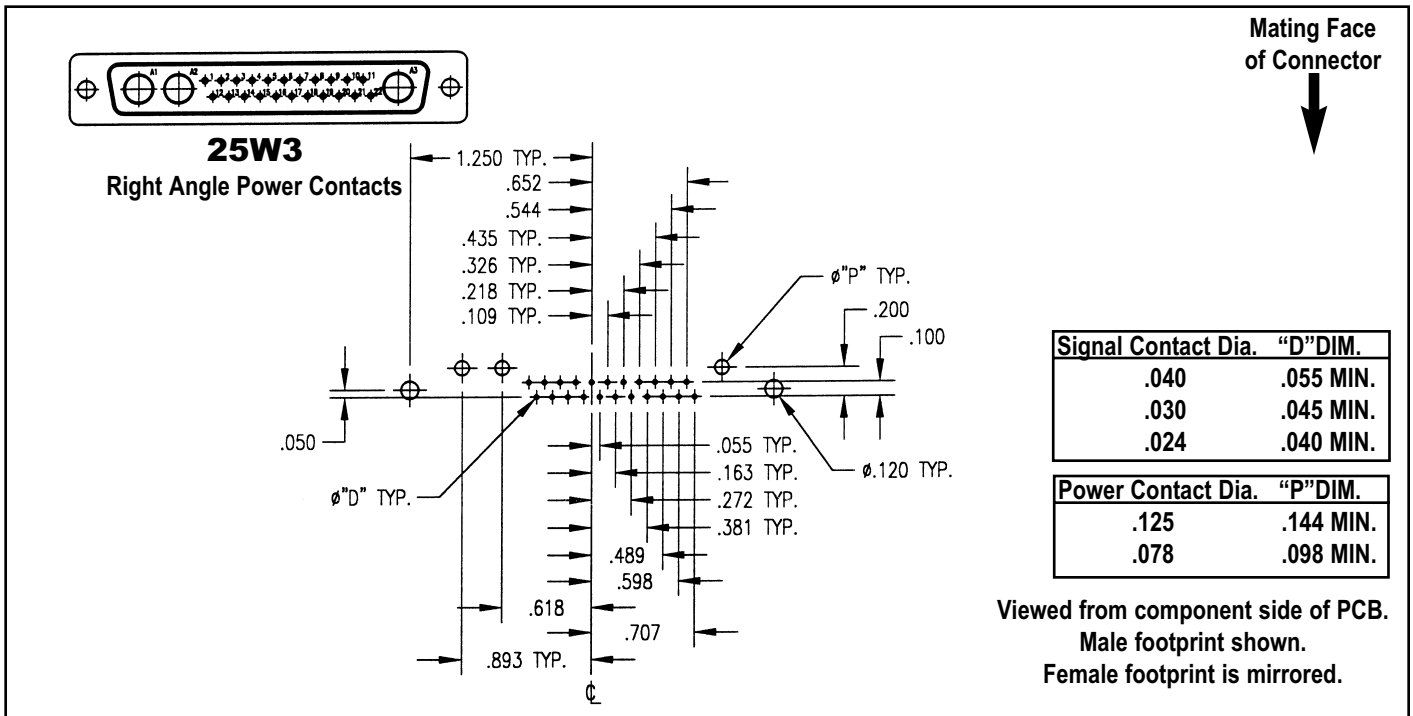
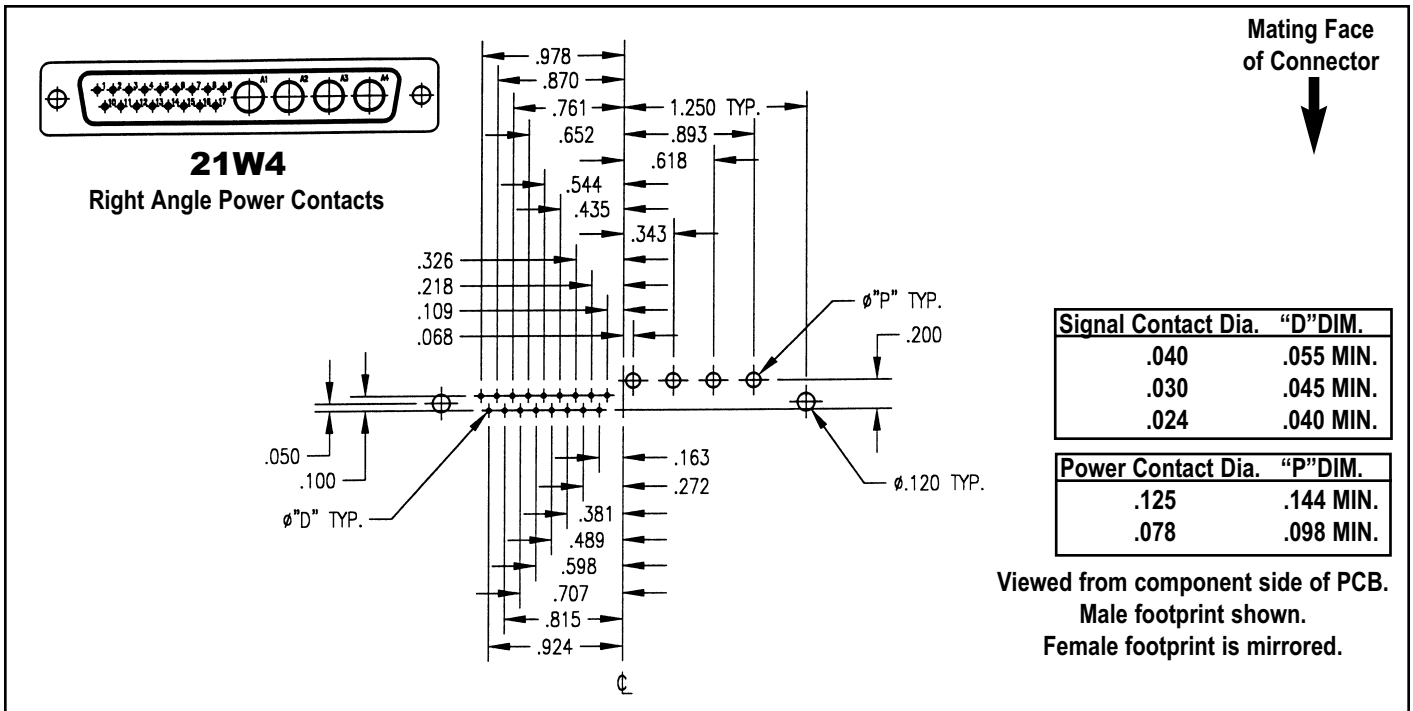

Dimensions shown are in inches.

D-SUBMINIATURE CONNECTORS: Footprints

Mating Face
of Connector

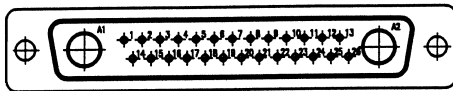

27W2

Right Angle Power Contacts

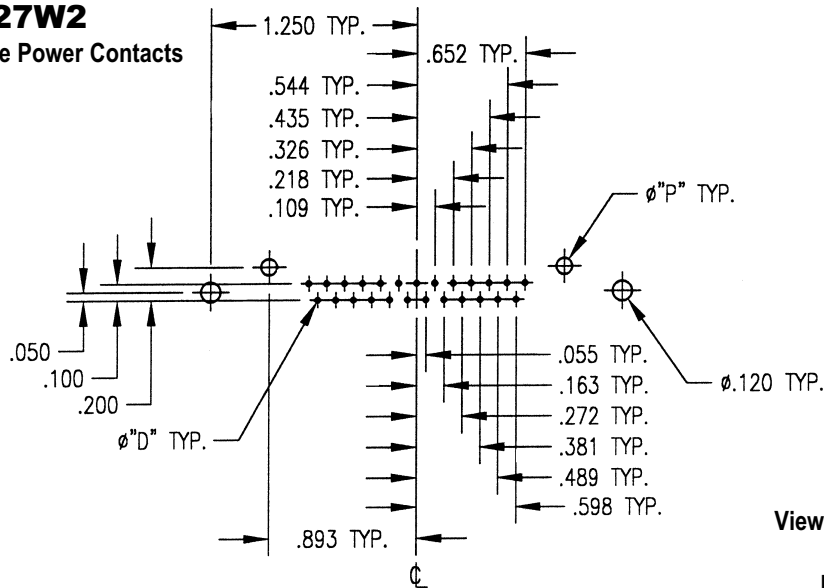

Signal Contact Dia. "D" DIM.	
.040	.055 MIN.
.030	.045 MIN.
.024	.040 MIN.

Power Contact Dia. "P" DIM.	
.125	.144 MIN.
.078	.098 MIN.

Viewed from component side of PCB.
Male footprint shown.
Female footprint is mirrored.

Mating Face
of Connector

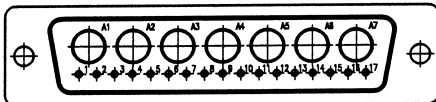

24W7

Right Angle Power Contacts

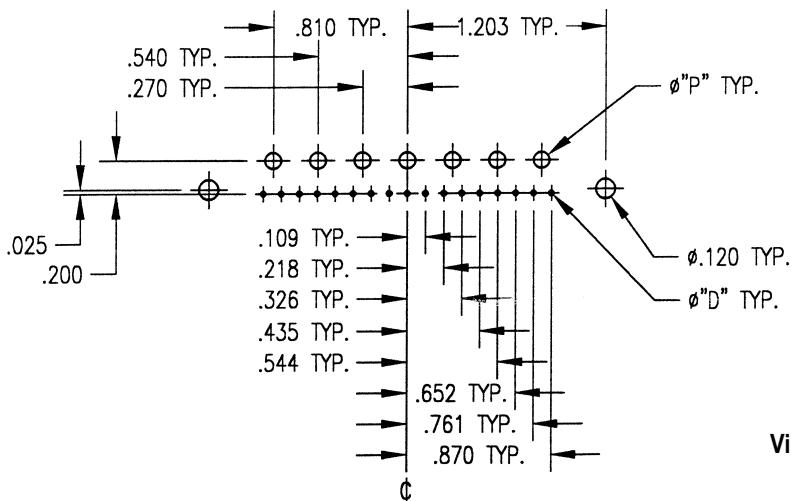

Signal Contact Dia. "D" DIM.	
.040	.055 MIN.
.030	.045 MIN.
.024	.040 MIN.

Power Contact Dia. "P" DIM.	
.125	.144 MIN.
.078	.098 MIN.

Viewed from component side of PCB.
Male footprint shown.
Female footprint is mirrored.

Dimensions shown are in inches.

D-SUBMINIATURE CONNECTORS: Footprints

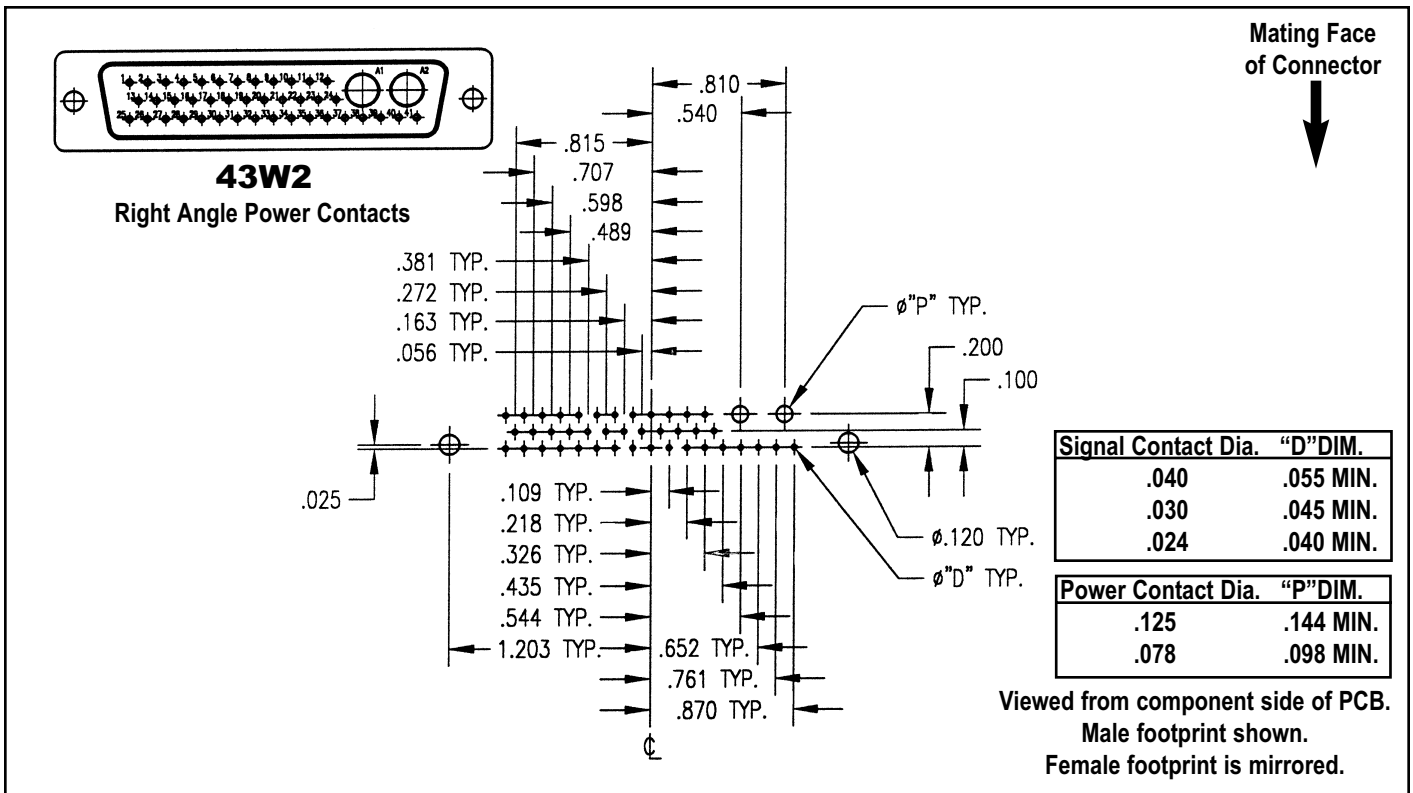
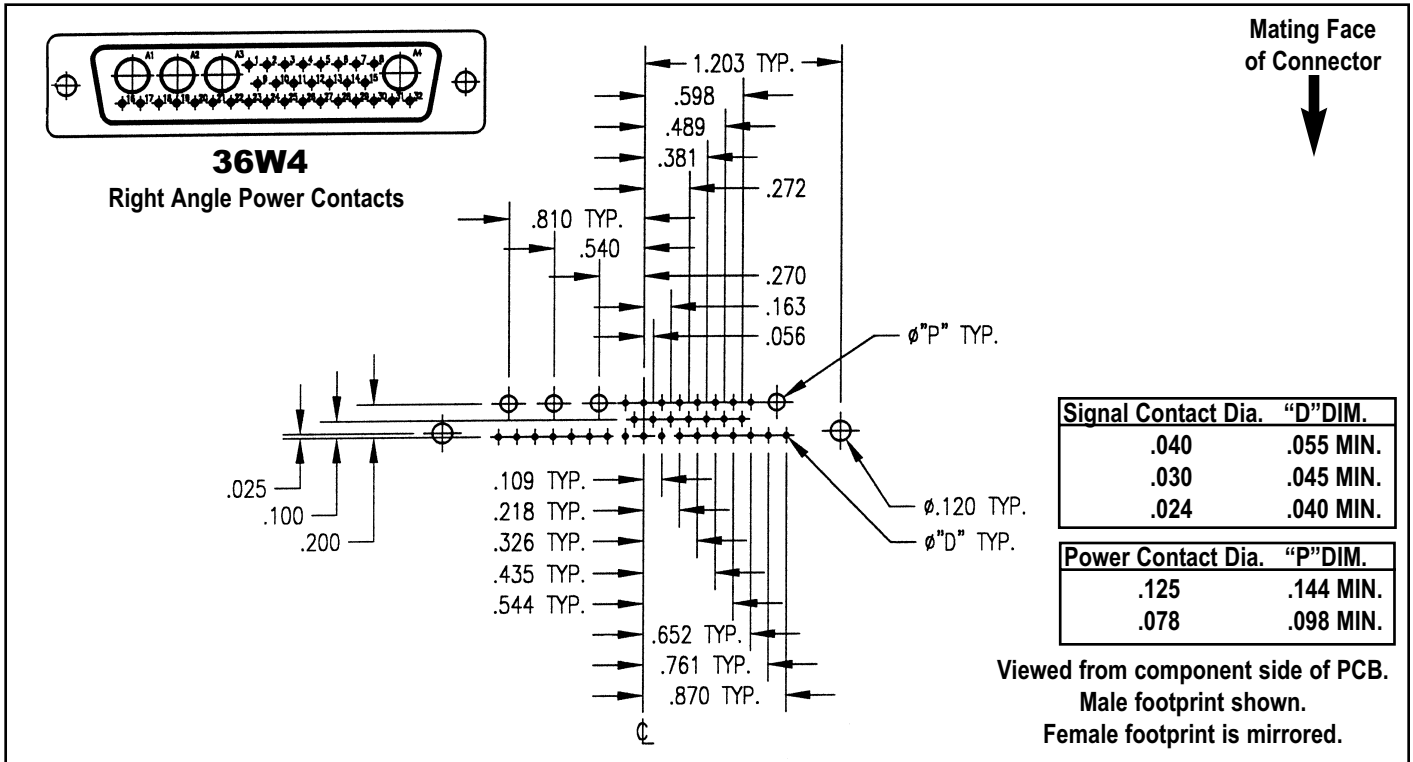

Dimensions shown are in inches.

D-SUBMINIATURE CONNECTORS: Footprints

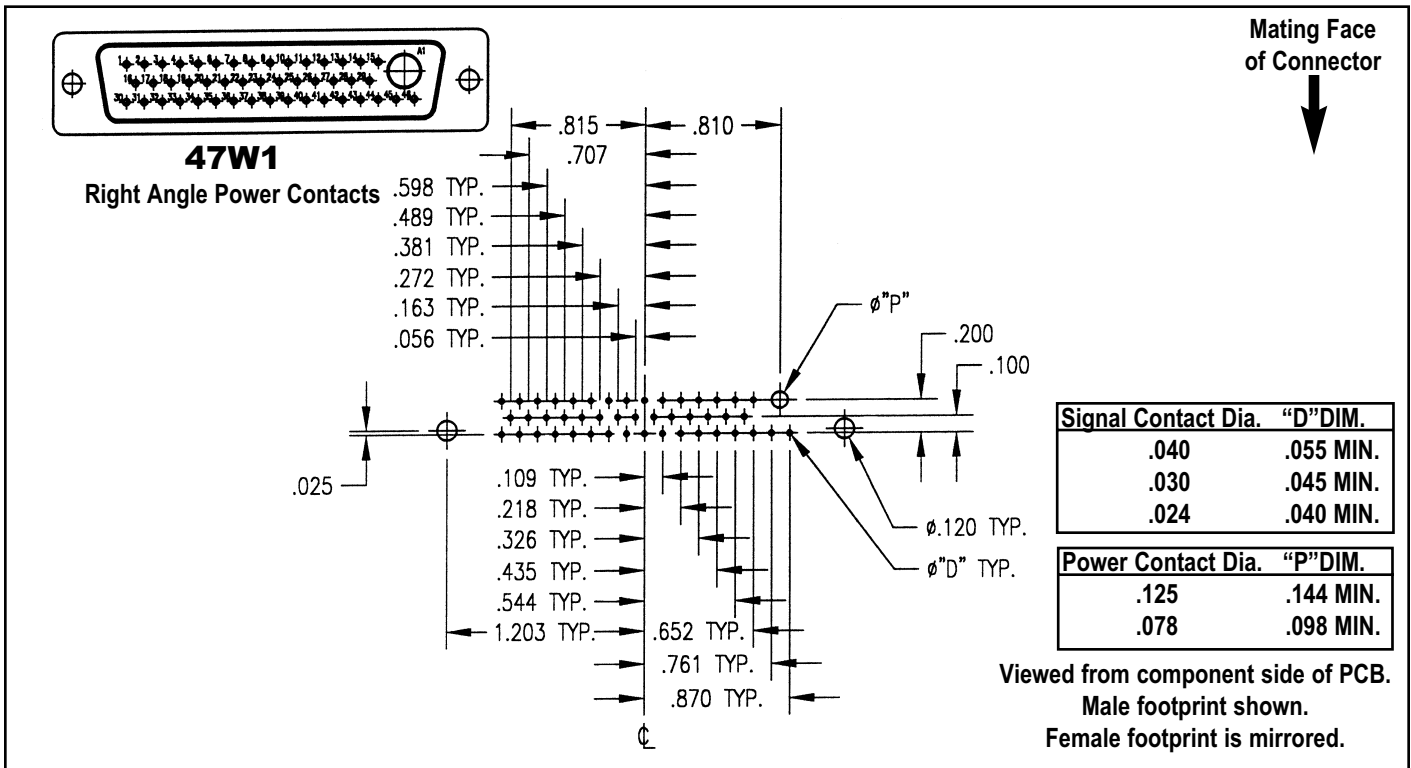

Dimensions shown are in inches.

CABLE REFERENCE TABLE

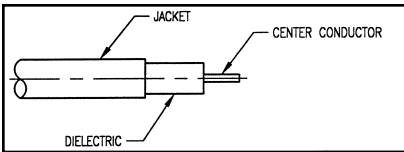
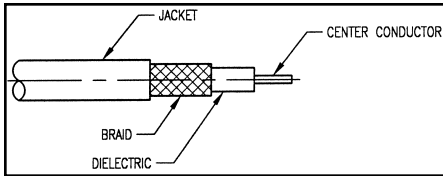

CABLE	CENTER CONDUCTOR	O.D. DIELECTRIC	O.D. JACKET	IMPEDANCE (Ohms)
RG-402	.0359	.1175	.141	50
RG-405	.0201	.0658	.086	50

CABLE	CENTER CONDUCTOR	O.D. DIELECTRIC	O.D. SHIELD	O.D. JACKET	IMPEDANCE (Ohms)
RG-8A/U	.0285	.285	-	.405	50
RG-9B/U	.0285	.280	-	.420	50
RG-55	.032	.116	.176	.176	50
RG-58	.038	.116	.150	.150	50
RG-58A	.0071	.116	-	.195	50
RG-59	.023	.146	.191	.191	75
RG-62	.025	.146	.191	.191	93
RG-62A	.0253	.146	-	.242	93
RG-71	.025	.146	.208	.208	93
RG-140	.025	.146	.176	.176	75
RG-141	.039	.116	.146	.146	50
RG-141A	.0390	.116	-	.190	50
RG-142	.039	.116	.171	.171	50
RG-174	.019	.060	.080	.080	50
RG-178	.012	.034	.054	.054	50
RG-179	.012	.060	.084	.084	75
RG-179B/U	.0040	.063	-	.100	75
RG-180	.012	.102	.124	.124	95
RG-187	.012	.060	.084	.084	75
RG-187A/U	.0040	.060	-	.11	75
RG-188	.020	.060	.081	.081	50
RG-188A/U	.0067	.060	-	.110	50
RG-195	.012	.102	.124	.124	95
RG-196	.012	.034	.054	.054	50
RG-210/U	.0253	.146	-	.242	93
RG-213/U	.0296	.285	-	.405	50
RG-214/U	.0296	.285	-	.425	50
RG-223	.032	.116	.176	.176	50
RG-303	.039	.116	.146	.146	50
RG-316	.020	.060	.081	.081	50
RG-316 DS	.020	.060	.102	.102	50

MOUNTING HOLE LAYOUTS

Number 040 A

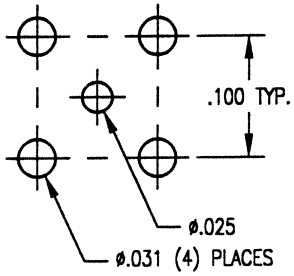

Number 050

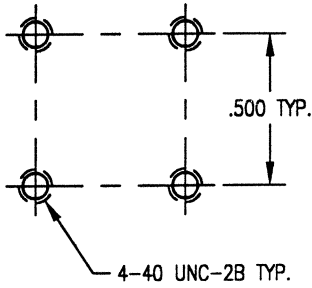

Number 055

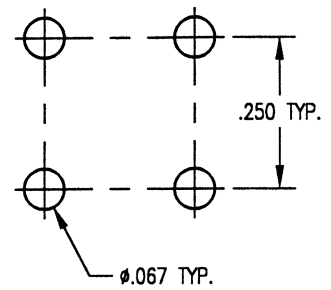

Number 060 A

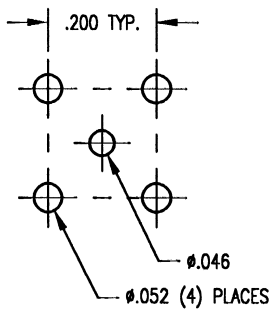

Number 060 B

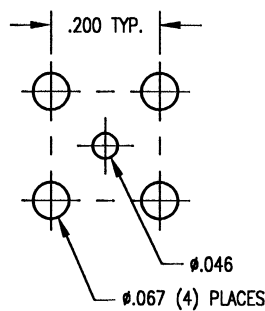

Number 060 C

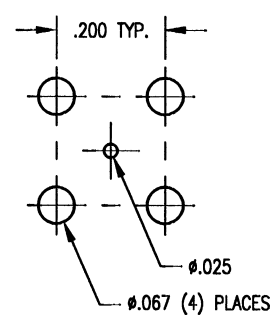

Number 061

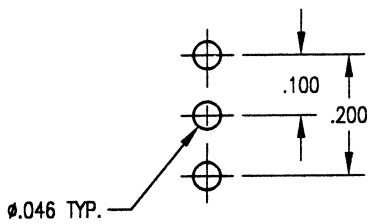

Number 065

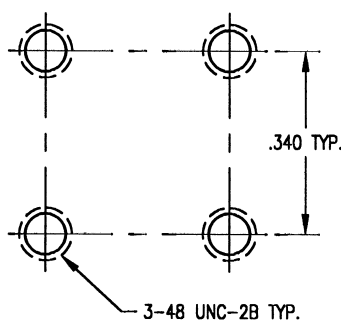

Number 066

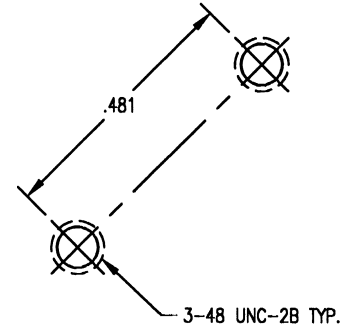

Number 069

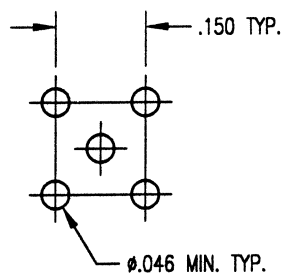

Number 070

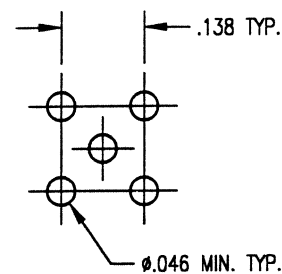

Dimensions shown are in inches.

Winchester/Retconn

400 Park Road • Watertown, Connecticut 06795-5000 • Phone: (860) 945-5000 • FAX: (860) 945-3950 • Internet: <http://www.litton-wed.com>

CABLE ASSEMBLY PROCEDURES: 5-07

Part Numbers		"A" Dim	"B" Dim	"C" Dim
200-510-0360G	201-510-0360G	1/4	5/16	5/64
200-510-0362G	201-510-0362G	9/32	7/32	5/64
200-510-0630G	201-510-0630G	1/4	5/16	5/64
200-510-1070G	201-510-1070G	5/16	3/8	5/64
200-510-1160G	201-510-1160G	5/16	3/8	5/64

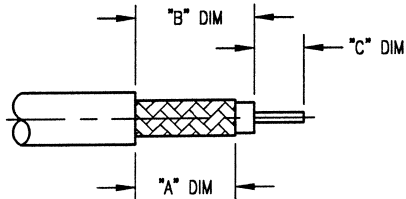

1. TRIM CABLE TO DIMENSIONS SHOWN. TIN THE CENTER CONDUCTOR.

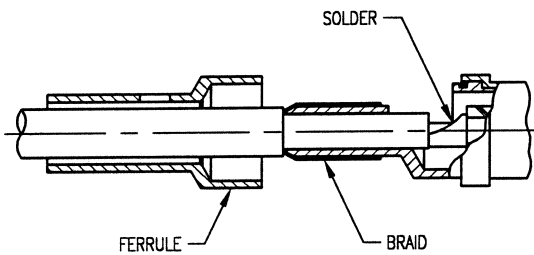

2. SLIDE FERRULE OVER JACKET. FLAIR BRAID. INSERT CABLE INTO BODY. CENTER CONDUCTOR MUST ENTER HOLE IN CONTACT. SOLDER CONDUCTOR TO CONTACT THROUGH SLOT IN BODY. CLEAN.

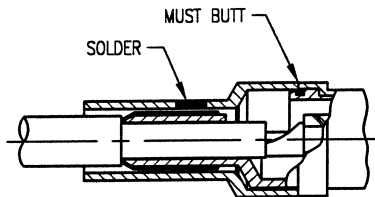

3. SLIDE FERRULE OVER BRAID UP TO THE SHOULDER OF BODY. SOLDER BRAID THROUGH HOLE IN FERRULE. CLEAN.

CABLE ASSEMBLY PROCEDURES: 5-08

Part Numbers		"A" Dim	"B" Dim	"C" Dim
202-510-0360G	203-510-0360G	15/64	3/8	1/16
202-510-0630G	203-510-0630G	15/64	3/8	1/16
202-510-1070G	203-510-1070G	5/16	27/64	3/32
202-510-1160G	203-510-1160G	5/16	27/64	3/32

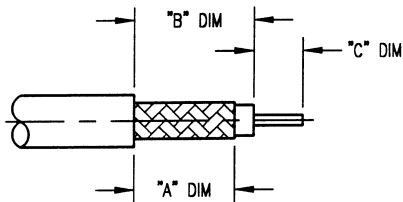

1. TRIM CABLE TO DIMENSIONS SHOWN. TIN THE CENTER CONDUCTOR.

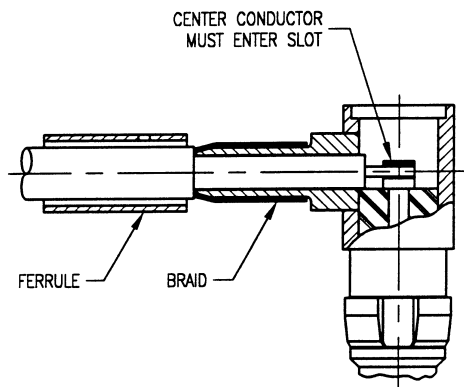

2. SLIDE FERRULE OVER JACKET. FLAIR BRAID. INSERT CABLE INTO BODY. CENTER CONDUCTOR MUST ENTER SLOT IN CONTACT. SOLDER CONTACT. CLEAN.

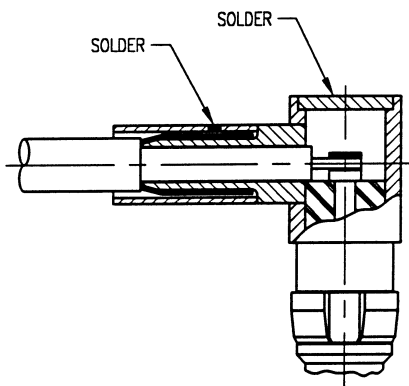

3. SLIDE FERRULE OVER BRAID UP TO THE SHOULDER OF BODY. SOLDER BRAID THROUGH HOLE IN FERRULE. CLEAN.

4. SOLDER CAP INTO BODY.

CABLE ASSEMBLY PROCEDURES: 5-09

Part Numbers		"A" Dim	"B" Dim
200-510-0850G	201-510-0360G	5/32	5/64
200-510-1410G	201-510-0630G	7/64	5/64
210-510-0850G	211-510-1070G	5/32	5/64
210-510-1410G	211-510-1160G	7/64	5/64
270-510-0850G	271-510-0850G	5/32	5/64
270-510-0850G	271-510-1410G	7/64	5/64

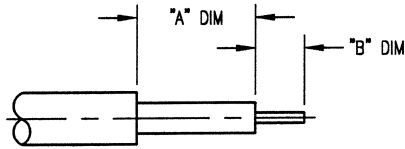

1. TRIM CABLE TO DIMENSIONS SHOWN. DO NOT NICK THE CENTER CONDUCTOR.

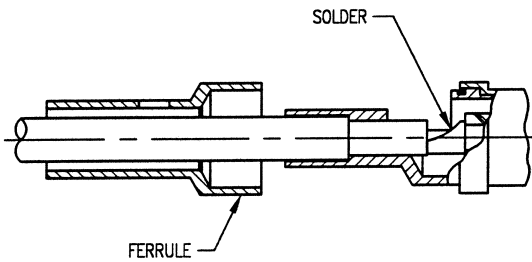

2. SLIDE FERRULE OVER JACKET. INSERT CABLE INTO BODY. CENTER CONDUCTOR MUST ENTER HOLE IN CONTACT. SOLDER CONDUCTOR TO CONTACT THROUGH SLOT IN BODY. CLEAN.

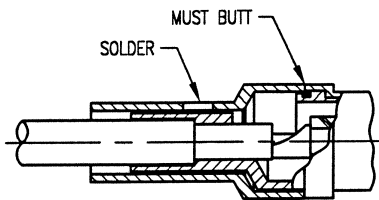

3. SLIDE FERRULE FORWARD UP TO THE SHOULDER OF BODY. SOLDER THROUGH HOLE IN FERRULE. CLEAN.

CABLE ASSEMBLY PROCEDURES: 5-10

Part Numbers		"A" Dim	"B" Dim
202-510-0360G	203-510-0360G	5/32	3/32
202-510-0630G	203-510-0630G	7/64	3/32
212-510-1070G	203-510-1070G	5/32	3/32
212-510-1160G	203-510-1160G	7/64	3/32
272-510-0850G	273-510-0850G	5/32	3/32
272-510-1410G	273-510-1410G	7/64	3/32

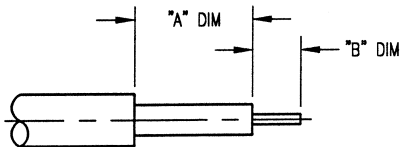

1. TRIM CABLE TO DIMENSIONS SHOWN. DO NOT NICK THE CENTER CONDUCTOR.

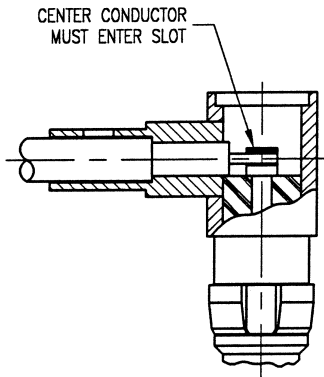

2. INSERT CABLE INTO BODY UNTIL IT BUTTS. CENTER CONDUCTOR MUST ENTER SLOT OF CONTACT.

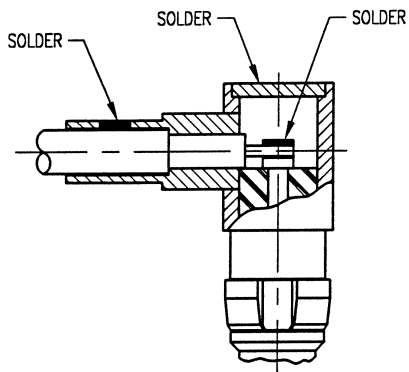

3. SOLDER CABLE JACKET INTO BODY.

4. SOLDER CENTER CONDUCTOR OF CABLE INTO SLOT OF CONTACT. SOLDER CAP INTO BODY.

CABLE ASSEMBLY PROCEDURES: 5-15

Part Numbers		"A" Dim
310-510-0850G	311-510-0850G	.020
310-510-1410G	311-510-1410G	.025
400-510-0850G	401-510-0850G	.020
400-510-1410G	401-510-1410G	.025

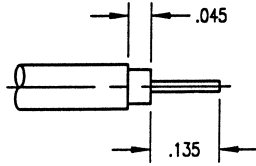

CABLE TRIM FOR
310-510-0850/311-510-0850
400-510-0850/401-510-0850

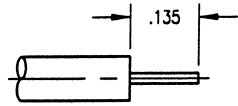

CABLE TRIM FOR
310-510-1410/311-510-1410
400-510-1410/401-510-1410

1. TRIM CABLE TO DIMENSIONS SHOWN. DO NOT NICK THE CENTER CONDUCTOR.

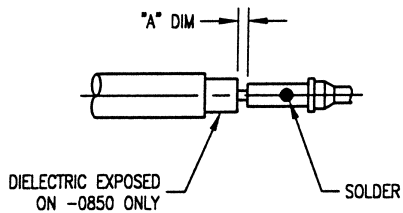

2. SOLDER CONTACT TO CENTER CONDUCTOR THROUGH THE HOLE IN THE CONTACT. SET GAP AS SHOWN.

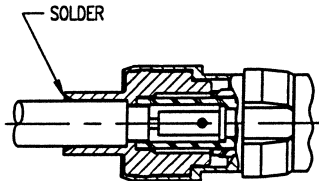

3. INSERT CENTER CONTACT INTO BODY UNTIL IT SNAPS INTO THE INSULATOR. SOLDER JACKET OF CABLE TO THE BODY.

CABLE ASSEMBLY PROCEDURES: 5-16

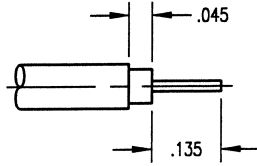

1. TRIM CABLE TO DIMENSIONS SHOWN. DO NOT NICK THE CENTER CONDUCTOR.

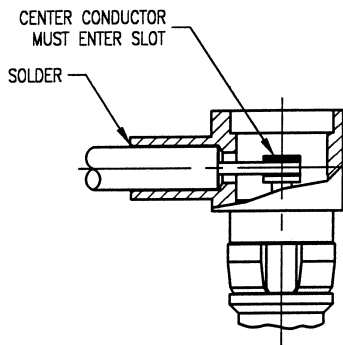

2. INSERT CABLE INTO BODY UNTIL IT BUTTS. CENTER CONDUCTOR MUST ENTER SLOT OF CONTACT.

3. SOLDER CABLE JACKET INTO BODY.

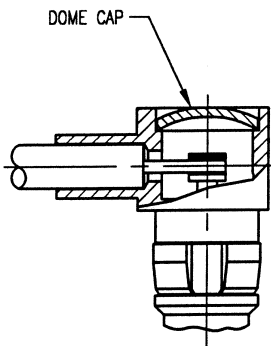

4. SOLDER CENTER CONDUCTOR OF CABLE INTO SLOT OF CONTACT. PLACE CAP IN BODY WITH DOME UP AND PRESS OR DIMPLE CAP.

CABLE ASSEMBLY PROCEDURES: 9-01

Part Numbers		"A" Dim	"B" Dim	"C" Dim
200-910-0360G	201-910-0360G	1/4	5/16	5/64
200-910-0630G	201-910-0630G	1/4	5/16	5/64
200-910-1070G	201-910-1070G	5/16	3/8	5/64
200-910-1160G	201-910-1160G	5/16	3/8	5/64

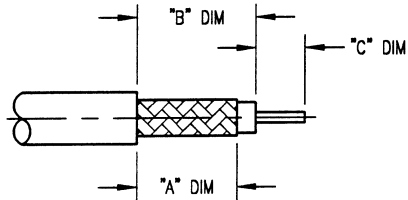

1. TRIM CABLE TO DIMENSIONS SHOWN. TIN THE CENTER CONDUCTOR.

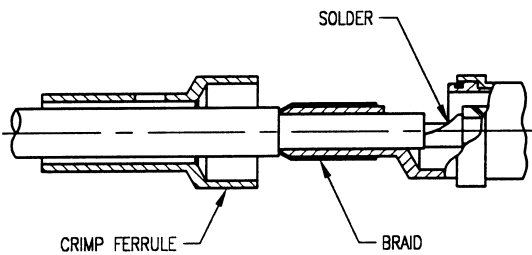

2. SLIDE FERRULE OVER JACKET. FLAIR BRAID. INSERT CABLE INTO BODY. CENTER CONDUCTOR MUST ENTER HOLE IN CONTACT. SOLDER CONDUCTOR TO CONTACT THROUGH SLOT IN BODY. CLEAN.

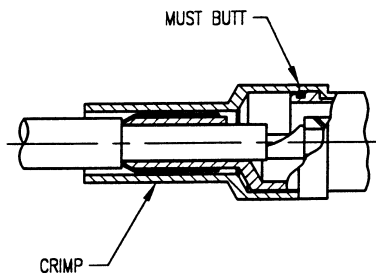

3. SLIDE FERRULE OVER BRAID UP TO THE SHOULDER OF BODY. CRIMP FERRULE TO RETAIN BRAID.

CABLE ASSEMBLY PROCEDURES: 9-02

Part Numbers		"A" Dim	"B" Dim	"C" Dim
202-910-0360G	203-910-0360G	15/64	3/8	1/16
202-910-0630G	203-910-0630G	15/64	3/8	1/16
202-910-1070G	203-910-1070G	5/16	27/64	3/32
202-910-1160G	203-910-1160G	5/16	27/64	3/32

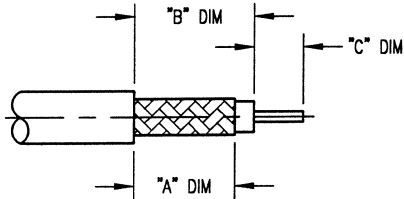

1. TRIM CABLE TO DIMENSIONS SHOWN. TIN THE CENTER CONDUCTOR.

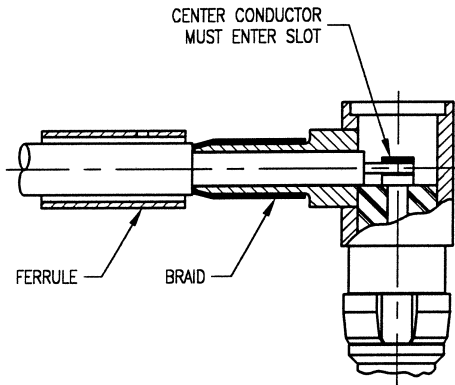

2. SLIDE FERRULE OVER JACKET. FLAIR BRAID. INSERT CABLE INTO BODY. CENTER CONDUCTOR MUST ENTER SLOT IN CONTACT. SOLDER CONTACT. CLEAN.

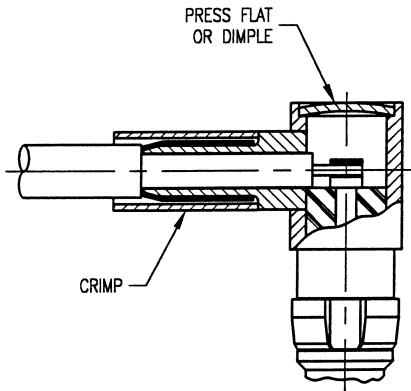

3. SLIDE FERRULE OVER BRAID UP TO THE SHOULDER OF BODY. CRIMP FERRULE TO RETAIN BRAID.

4. PLACE DOME CAP INTO BODY AND PRESS FLAT OR DIMPLE.

CABLE ASSEMBLY PROCEDURES: 9-07

Part Numbers		Center Contact Only		
		Crimp Tool	Positioner	Setting
240-910-0630G	241-910-0630G	T2400	P0630	4
240-910-1070G	241-910-1070G	T2400	P0630	4
260-910-0630G	261-910-0630G	T2400	P0630	4
260-910-1160G	261-910-1160G	T2400	P0630	7
260-910-1161G	261-910-1161G	T2400	P0630	7
290-910-0630G	291-910-0630G	T2400	P0630	4
290-910-1160G	291-910-1160G	T2400	P0630	7
290-910-1161G	291-910-1161G	T2400	P0630	7

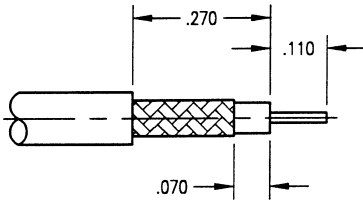

1. TRIM CABLE TO DIMENSIONS SHOWN. TIN THE CENTER CONDUCTOR.

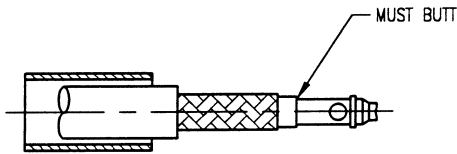

2. SLIDE FERRULE OVER JACKET. PLACE CENTER CONTACT INTO POSITIONER. INSERT CENTER CONDUCTOR OF CABLE INTO CONTACT. DIELECTRIC OF CABLE MUST BUTT AGAINST CONTACT. CRIMP. SEE TABLE FOR POSITIONER AND SETTING.

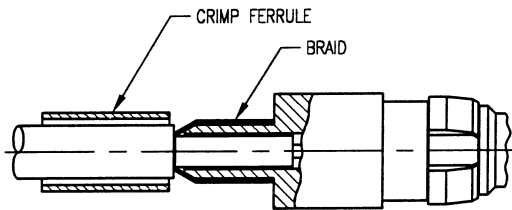

3. FLAIR BRAID. INSERT CENTER CONTACT INTO BODY.

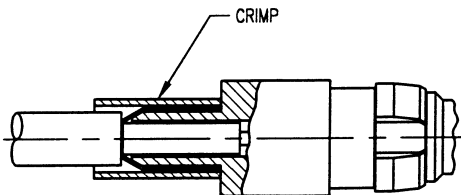

4. SLIDE FERRULE OVER BRAID UP TO THE SHOULDER OF BODY. CRIMP FERRULE TO RETAIN BRAID.

CABLE ASSEMBLY PROCEDURES: 9-16

Part Numbers		"A" Dim	"B" Dim	Ferrule Hex. Size
312-910-0630G	313-910-0630G	.234	.312	.128
312-910-0631G	313-910-0631G	.234	.312	.151
312-910-1160G	313-910-1160G	.312	.375	.213
312-910-1161G	313-910-1161G	.312	.375	.213

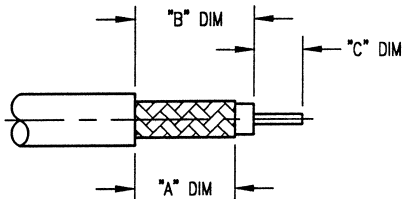

1. TRIM CABLE TO DIMENSIONS SHOWN. TIN THE CENTER CONDUCTOR.

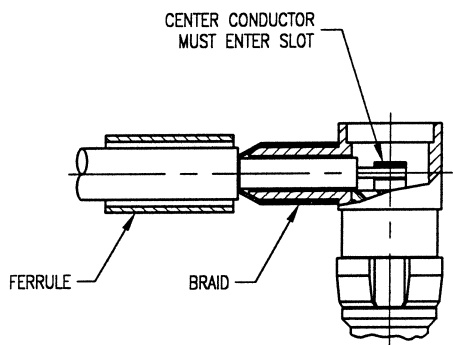

2. SLIDE FERRULE OVER JACKET. FLAIR BRAID. INSERT CABLE INTO BODY. CENTER CONDUCTOR MUST ENTER SLOT IN CONTACT. SOLDER CONTACT. CLEAN.

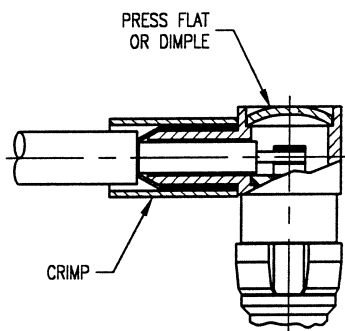

3. SLIDE FERRULE OVER BRAID UP TO THE SHOULDER OF BODY. CRIMP FERRULE TO RETAIN BRAID. SEE TABLE FOR HEX SIZES.

4. PLACE DOME CAP INTO BODY AND PRESS FLAT OR DIMPLE.

Dimensions shown are in inches.

Winchester/Retconn

400 Park Road • Watertown, Connecticut 06795-5000 • Phone: (860) 945-5000 • FAX: (860) 945-3950 • Internet: <http://www.litton-wed.com>

Connector Tools

Crimp Tool (For HEX Dies)

Part Number
T-1001

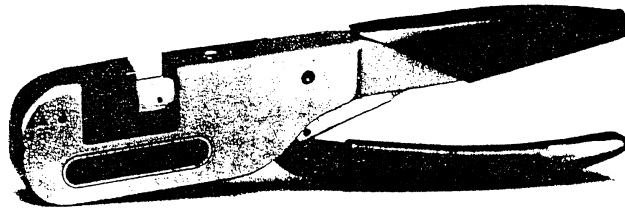

Die Set

Part Number	A HEX	Length	B HEX	Length
T-1001-2	.128	.325	.105	.325
T-1001-3	.213	.325	.178	.325
T-1001-5	.314	.400	.155	.400

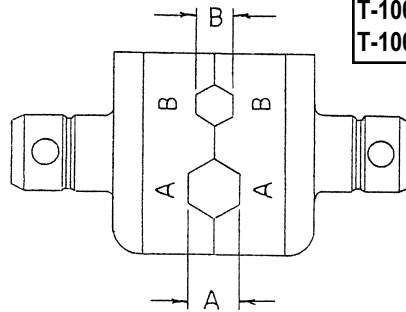
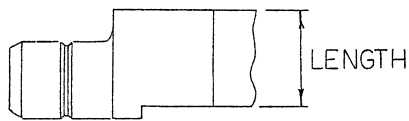

Note: To be used with crimp tool (T-1001)

Center Contact Crimping Tool

Part Number
T-2400

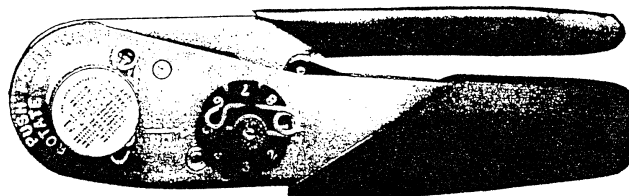

Positioner

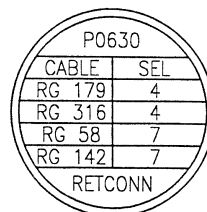
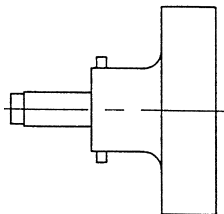

MARKING LABEL

Note: To be used with center contact crimping tool (T-2400)

Part Number
P0630

Dimensions shown are in inches.

Connector Tools

Contact Withdrawl Tool

Part Number
T-1000

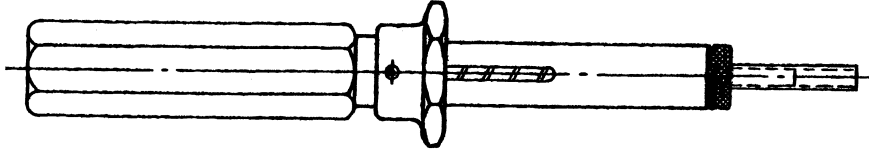

Tool For Inserting Stabilizing Ring Into Housing

Part Number
T-1004

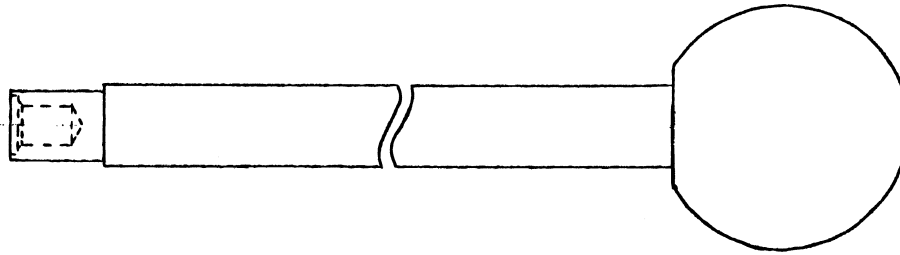

Insertion Tool Coax Contacts

Part Number
T-1003

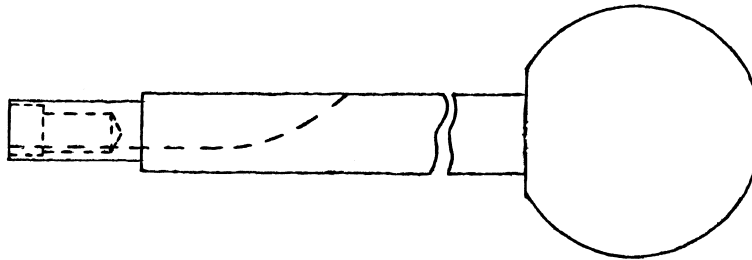

Dimensions shown are in inches.

Other Product Offerings

C-Press® Winchester press-fit compliant pin connectors

- D-Subs - standard and hybrid
- Headers- IDC, strip, power
- Telecom plastic and metal
- Coax - 50 and 70 Ohm power terminals
- Cardedge
- Contacts - reels and strips
- Industry standard high density L-Series
- Modular high density HD+™
- DIN 41612 Standard, Inverse, Hybrid
- Right angle press-fit
- Guided DIN
- Switching DIN

Standard PCB Connectors Solder type

- D-Subs - right angle, straight, hybrid
- DIN - Standard, inverse, hybrid
- Rack & Panel - rectangular, round, miniature, subminiature
- V.35 - right angle, straight, high or low profile
- Headers - IDC type
- MIL-C-55302
- Two piece cardedge
- MetCon™ 1&2, 2mm high density
- RF Coaxial Connectors

Standard Cable Type Connectors

- D-Subs - IDC
- Rack & Panel - Crimp, V.35, MIL-C-28748, MIL-C-39029, hybrid
- RF Coaxial Connectors

Unique Products

- Metalized plastic connectors
- USECO - terminals, hardware, terminal boards and more!
- Wireless LAN Antennas
- Interconnect Filtering - Inexpensive EMI filtering of most connectors
- A variety of Rack & Panel - cable to cable, PCB to PCB, Cable to PCB
- A variety of Power Connectors

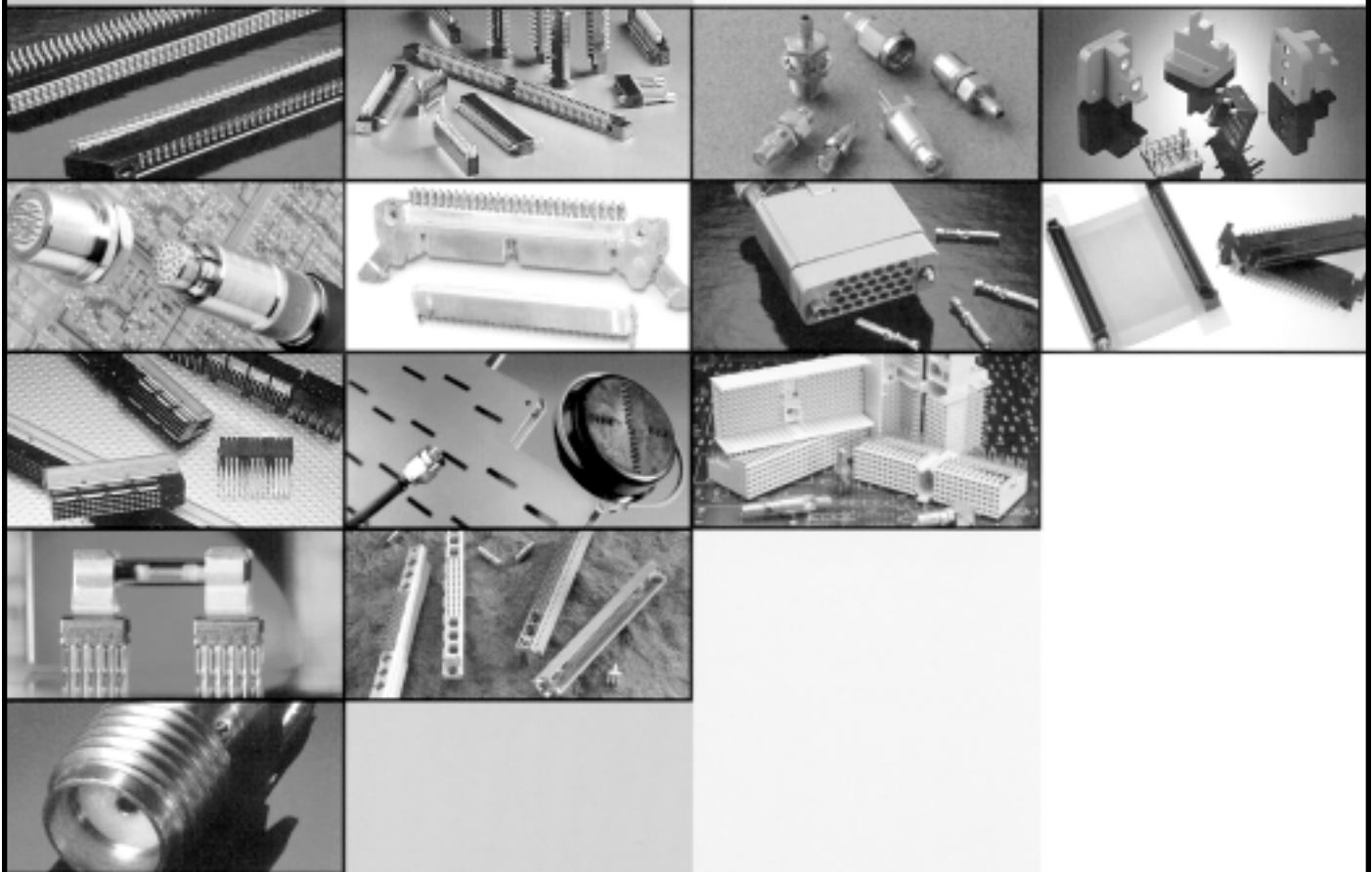

Other Product Offerings

Our
Products
are limited
only by your
imagination

The following list of questions will help define your requirements for additional information on our product offerings

Customer Information

Customer Name

Address

City

State

Zip

Contact Name

Telephone

Fax

Please have a Winchester Electronics Representative Call.

Product Offerings

For specific product information, check box next to the product description.

C-Press®

Winchester's press-fit compliant pin connectors

- D-Subs - standard and hybrid
- Headers-IDC, strip, power
- Telecom plastic and metal
- Coax - 50 and 70 Ohm power terminals
- Cardedge
- Contacts - reels and strips
- Industry standard high density L-Series
- Modular high density HD+™
- DIN 41612 Standard, Inverse, Hybrid
- Right angle press-fit
- Guided DIN
- Switching DIN

Standard Cable Type Connectors

- D-Subs - IDC
- Rack & Panel - Crimp, V.35, MIL-C-28748, MIL-C-39029, hybrid
- RF Coaxial Connectors

Standard PCB Connectors

Solder type

- D-Subs - right angle, straight, hybrid
- DIN - Standard, inverse, hybrid
- Rack & Panel - rectangular, round, miniature, subminiature
- V.35 - right angle, straight, high or low profile
- Headers - IDC type
- MIL-C-55302
- Two piece cardedge
- MetCon™ 1&2, 2mm high density
- RF Coaxial Connectors

Unique Products

- Metalized plastic connectors
- USECO - terminals, hardware, terminal boards and more!
- Wireless LAN Antennas
- Interconnect Filtering - Inexpensive EMI filtering of most connectors
- A variety of Rack & Panel - cable to cable, PCB to PCB, Cable to PCB
- A variety of Power Connectors

Headquarters

Winchester/Retconn
400 Park Road
Watertown, CT 06795-0500 USA
Telephone: 860-945-5000
Fax: 860-945-5191
Internet: <http://www.litton-wed.com>

United Kingdom

Litton Precision Products International, Inc.
6 First Ave., Globe Park
Marlow, Bucks
SL7 1YA England
Telephone: 44-1-628-486060
Fax: 44-1-628-472438

Italy

Veam S.r.l.
Via Statuto 2
20020 Arese
Milan, Italy
Telephone: 39-02-935-321
Fax: 39-02-938-5000

France

Litton Precision Products International, Inc.
2 Rue de Marly - BP 75
78-151 Le Chesnay Cedex
France
Telephone: 33-1-392-38300
Fax: 33-1-395-55068
E-Mail: lpiffr@aol.com

Germany

Litton Precision Products International, Inc.
Oberfoehringer Strasse 8
D-81679 Munich, Germany
Telephone: 49-89-922040
Fax: 49-89-985184
E-Mail: germany@littonppi.com

Spain

Litton Precision Products International, Inc.
Condes de Val 8
28036 Madrid, Spain
Telephone: 34-91-344-0144
Fax: 34-91-344-0102
E-Mail: litton@iponet.es

Scandinavia

Litton Precision Products International, Inc.
Heliosvagen 1B
Box 92146
S-120 08 Stockholm, Sweden
Telephone: 46-8-743-0585
Fax: 46-8-643-5220
E-Mail: lpipi@litton.se

Benelux

Litton Precision Products International, Inc.
Griendstraat 10
NL-2921 LA Krimpen a/d IJssel
The Netherlands, Holland
Telephone: 31-180-596888
Fax: 31-180-596899
E-Mail: littonnl@worldaccess.nl

Switzerland

Litton Precision Products International, Inc.
Gubelstrasse 28
CH-8050 Zurich
Switzerland
Telephone: 41-1-313-1001
Fax: 41-1-313-1255
E-Mail: info@littonppi.ch

Far East

Connector Operations
Division of Litton Worldwide Services, Inc.
Rm. #301, Hayama No. 5 Building
1-3-1, Shin Yokohama, Kohoku-Ku
Yokohama, Kanagawa 222
Japan
Telephone: 81-45-477-5115
Fax: 81-45-475-3200

Australia (Sydney)

Litton Precision Products International, Inc.
P.O. Box 1133
Crows Nest N.S.W. 1585
Sydney, Australia
Telephone: 61-2-9460-3666
Fax: 61-2-9460-3777

Australia (Melbourne)

Litton Precision Products International, Inc.
P.O. Box 310
Essendon, VIC 3040
Melbourne, Australia
Telephone: 61-3-9375-3838
Fax: 61-3-9370-0061

Czech Republic

Litton Precision Products International, Inc.
Videnska 125
CZ-619 00 Brno
Czech Republic
Telephone: 420-5-4712 5340
Fax: 420-5-4712 5348
E-Mail: info@littonppi.ch

Litton

Winchester/Retconn

Re-order Number: CAT-COMBO-D2000