

PLEASE CHECK WWW.MOLEX.COM FOR LATEST PART INFORMATION

Part Number: [0512160300](#)
Status: **Active**
Description: 2.00mm (.079") Pitch Wire-to-Board and Wire-to-Wire Receptacle Housing, Positive Lock, 3 Circuits

Documents:

3D Model	Product Specification PS-51216-006 (PDF)
Drawing (PDF)	Product Specification PS-51216-007 (PDF)
Product Specification PS-51216-005 (PDF)	RoHS Certificate of Compliance (PDF)

General

Product Family	Crimp Housings
Series	51216
Product Name	N/A

Physical

Circuits (maximum)	3
Color - Resin	Natural
Gender	Female
Glow-Wire Compliant	No
Lock to Mating Part	Yes
Material - Resin	Polyester
Number of Rows	1
Packaging Type	Bag
Panel Mount	No
Pitch - Mating Interface (in)	0.079 In
Pitch - Mating Interface (mm)	2.00 mm
Stackable	No
Temperature Range - Operating	-25°C to +85°C

Electrical

Current - Maximum per Contact	2.5A
-------------------------------	------

Material Info

Reference - Drawing Numbers

Product Specification	PS-51216-005, PS-51216-006, PS-51216-007, RPS-51216-003, RPS-51216-004, RPS-51216-005, RPS-51216-006, RPS-51216-007, RPS-51216-008, RPS-51216-009, RPS-51216-010, RPS-51216-011, RPS-51216-012, RPS-51216-013
Sales Drawing	SD-51216-004

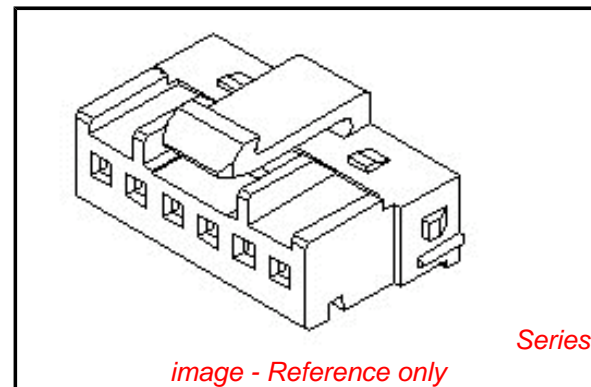

EU RoHS

ELV and RoHS Compliant
REACH SVHC
Contains SVHC: No
Halogen-Free
Status

China RoHS



Need more information on product environmental compliance?

Email productcompliance@molex.com
 For a multiple part number RoHS Certificate of Compliance, [click here](#)

Please visit the [Contact Us](#) section for any non-product compliance questions.

Search Parts in this Series

[51216Series](#)

Mates With

[512270300](#)

Use With

[59370-8000](#) , [59370-8100](#) , [512170305](#)

注記
NOTES

- △1 適合ターミナル : 59370シリーズ
APPLICABLE TERMINAL : 59370 SERIES
- △2 適合リテーナー : 51217シリーズ
APPLICABLE RETAINER : 51217 SERIES
- 3. 嵌合相手 : 55487シリーズ
MATE WITH : 55487 SERIES
- △4 偶数極に適用。
APPLY EVEN CIRCUIT PRODUCTS.
- △5 4~15極に適用。
APPLY 4-15 CIRCUITS.
- △6 5~15極に適用。
APPLY 5-15 CIRCUITS.

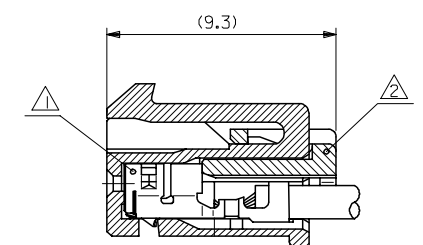

ターミナル及びリテーナー装着状態図
TERMINAL & RETAINER ASSEMBLY DRAWING

30.9	29.3	7.4	3.7	28	31.8	51216-1500	15
28.9	27.3			26	29.8	-1400	14
26.9	25.3			24	27.8	-1300	13
24.9	23.3			22	25.8	-1200	12
22.9	21.3			20	23.8	-1100	11
20.9	19.3			18	21.8	-1000	10
18.9	17.3			16	19.8	-0900	9
16.9	15.3			14	17.8	-0800	8
14.9	13.3			12	15.8	-0700	7
12.9	11.3			10	13.8	-0600	6
10.9	9.3	7.4		8	11.8	-0500	5
8.9	7.3			6	9.8	-0400	4
6.9			3.7	4	7.8	-0300	3
4.9			2.2	2	5.8	51216-0200	2
F	E	D	C	B	A	MATERIAL NO.	CKT.

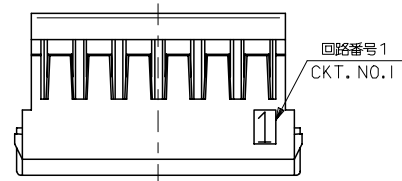

VIEW "H"

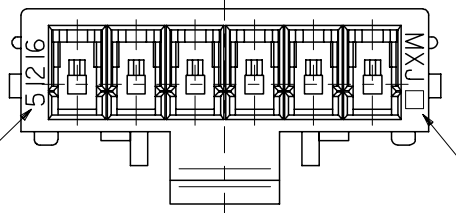
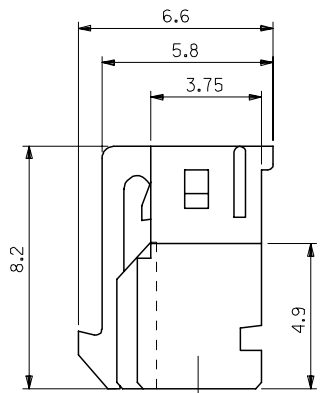

製品番号
ENG. NO.

トレードマーク
& キャビティ番号
TRADE MARK
& CAV. NO.

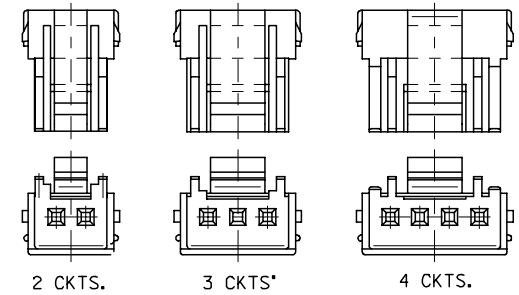
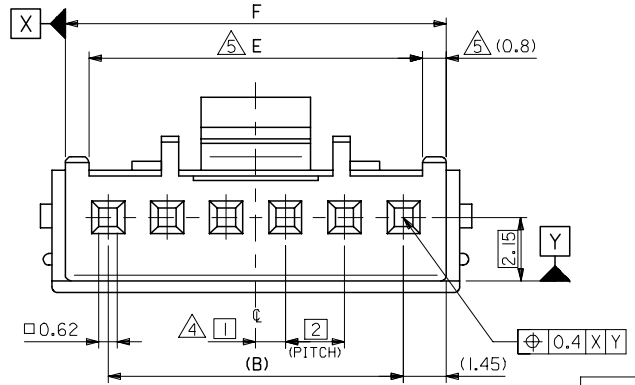
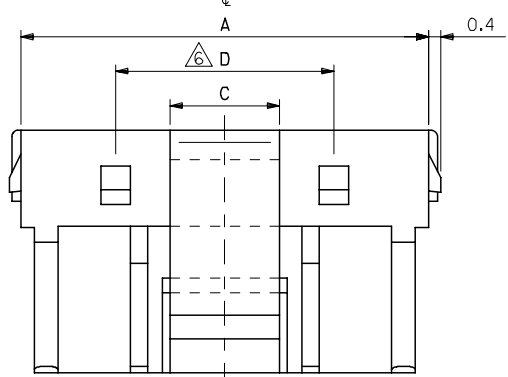

LAYOUT OF EACH CKTS.

GENERAL TOLERANCES
(UNLESS SPECIFIED)

10 UNDER	±0.2
10 OVER 30 UNDER	±0.25
30 OVER	±0.3
ANGULAR	±3 °

DRAFT WHERE APPLICABLE
MUST REMAIN
WITHIN DIMENSIONS

DIMENSION STYLE MM ONLY	
DRAWN BY T. YASUI	DATE '00/2/22
CHECKED BY T. YAMAGUCHI	DATE '00/2/22
APPROVED BY M. FUKUSHIMA	DATE '00/2/22
MATERIAL NO.	

SCALE ---	DESIGN UNITS METRIC	THIRD ANGLE PROJECTION
TITLE 2.0MM WIRE TO BOARD RECEPTACLE HOUSING		
MOLEX MOLEX INCORPORATED		
ENTER PART SD-51216-004	DOCUMENT NO.	SHEET NO. 1 OF 1
SIZE A3 THIS DRAWING CONTAINS INFORMATION THAT IS PROPRIETARY TO MOLEX INCORPORATED AND SHOULD NOT BE USED WITHOUT WRITTEN PERMISSION		