

PLEASE CHECK WWW.MOLEX.COM FOR LATEST PART INFORMATION

Part Number: [0511140300](#)
Status: **Active**
Description: 3.50mm (.138") Pitch Wire-to-Wire Plug Housing, Positive Lock, With Optional Panel Mount, 3 Circuits

Documents:

[3D Model](#) [Product Specification PS-51067-008 \(PDF\)](#)
[Drawing \(PDF\)](#) [RoHS Certificate of Compliance \(PDF\)](#)

Agency Certification

CSA	LR19980
TUV	R72081037
UL	E29179

General

Product Family	Crimp Housings
Series	51114
Product Name	N/A

Physical

Circuits (maximum)	3
Color - Resin	Natural
Flammability	94V-0
Gender	Male
Glow-Wire Compliant	No
Material - Resin	Polyester
Number of Rows	1
Packaging Type	Bag
Panel Mount	Yes
Pitch - Mating Interface (in)	0.138 In
Pitch - Mating Interface (mm)	3.50 mm
Stackable	No
Temperature Range - Operating	-40°C to +105°C

Material Info

Reference - Drawing Numbers

Product Specification	PS-51067-008, RPS-51067-020
Sales Drawing	SD-51114-**00

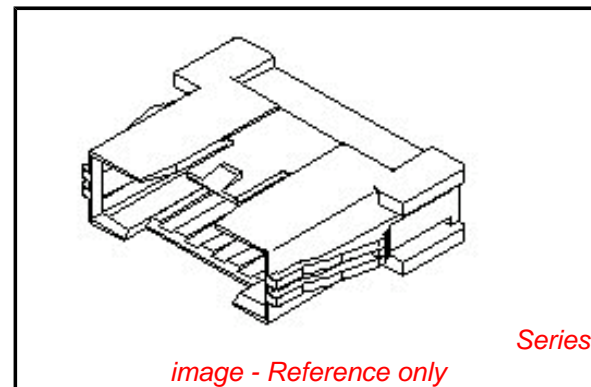

EU RoHS

ELV and RoHS Compliant
REACH SVHC Contains SVHC: No
Halogen-Free Status

China RoHS



Not Halogen-Free

Need more information on product environmental compliance?

Email productcompliance@molex.com
 For a multiple part number RoHS Certificate of Compliance, [click here](#)

Please visit the [Contact Us](#) section for any non-product compliance questions.

Search Parts in this Series

[51114Series](#)

Mates With

[51067](#)

Use With

[50419](#)

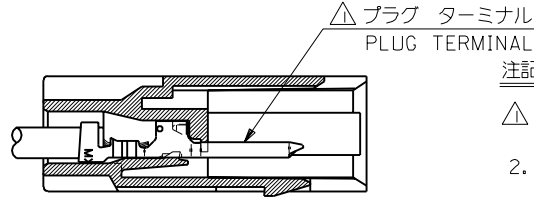
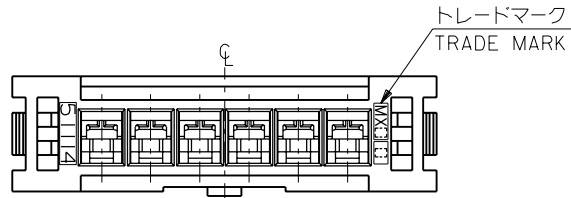

注記 NOTES

- △ 適合プラグ ターミナル : 50419-****
APPLICABLE PLUG TERMINAL : 50419-****
- 2. 嵌合相手 : 51067 シリーズ
MATE WITH : 51067 SERIES
- △ 偶数極の製品に適用。
APPLY EVEN CIRCUIT PRODUCTS.
- 4. ハウジングは、パネル打ち抜き側から挿入すること。
INSERT HOUSING FROM PUNCH SIDE OF PANEL.

ターミナル装着状態図
TERMINAL ASSEMBLY DRAWING

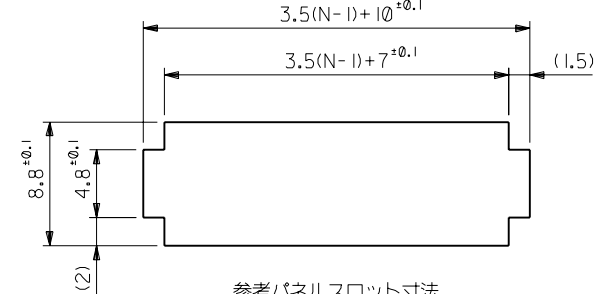
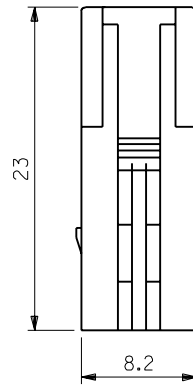
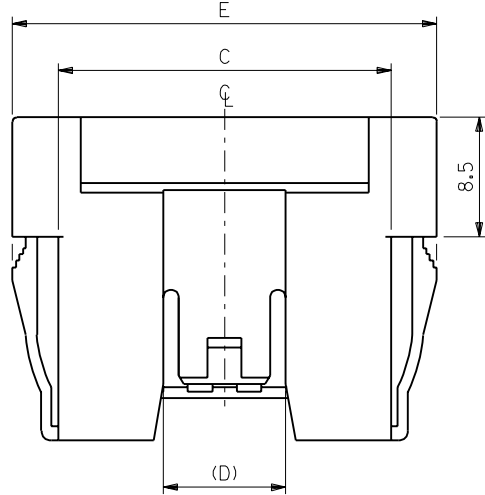

参考パネルスロット寸法
(パネル厚 : 0.8 ~ 2.0)
PANEL SLOT DIM. (REF.)
(THICKNESS : 0.8 - 2.0)

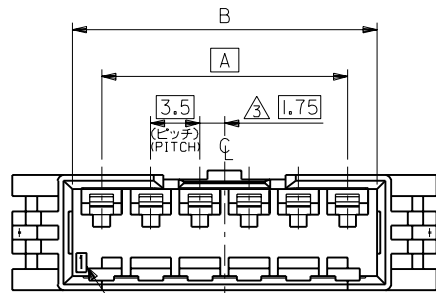

回路番号
CIRCUIT NO.

44.2	8.7	37.7	35.7	31.5	51114-1000	10
40.7		34.2	32.2	28.0	-0900	9
37.2		30.7	28.7	24.5	-0800	8
33.7		27.2	25.2	21.0	-0700	7
30.2		23.7	21.7	17.5	-0600	6
26.7		20.2	18.2	14.0	-0500	5
23.2	8.7	16.7	14.7	10.5	-0400	4
19.7	6.1	13.2	11.2	7.0	-0300	3
16.2	6.1	9.7	7.7	3.5	51114-0200	2
E	(D)	C	B	A	ENG. NO.	CKT. 極数

角度 ANGLE		±3°				材料 MATERIAL		PBT, UL94V-0	
30以上 OVER		±0.3				仕上げ FINISH		— # —	
10以上 OVER 30未滿 UNDER		±0.25		A 変更 (J40265)		適用電線範囲 WIRE RANGE		— # —	
10未滿 UNDER		±0.2		O 新規作成 (J30900)		被覆外径 INS. RANGE		— # —	
一般公差 GENERAL TOLERANCES		記号 LTR		変更内容 REVISION RECORD		DR. DATE		M.F. H.H. '94/4/1	
								CHK'D BY '94/4/1	
								M.FUJIKURA H.HIRAMOTO	
								APP'D BY '94/4/1	
								M.FUKUSHIMA 尺度 3 : 1	

材料 MATERIAL		PBT, UL94V-0	
仕上げ FINISH		— # —	
適用電線範囲 WIRE RANGE		— # —	
被覆外径 INS. RANGE		— # —	
DRAWN BY '93/5/24		CHK'D BY '94/4/1	
M.FUJIKURA		H.HIRAMOTO	
APP'D BY '94/4/1		M.FUKUSHIMA	
DWG. NO.		REV	
SD-51114-***00		A	