

900MHz Band LNA GaAs MMIC

■ GENERAL DESCRIPTION

The NJG1138HA8 is a low noise amplifier designed for band 5/6/8 UMTS cellular phone and cellular data modem. The NJG1138HA8 has two gain state which are high gain mode and low gain mode. The NJG1138HA8 features high gain, low noise figure and high IP3.

An Ultra-small and thin USB6-A8 package is adopted.

■ PACKAGE OUTLINE

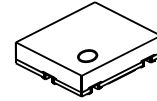

NJG1138HA8

■ FEATURES

- Low operating voltage +2.8V typ.
- Low control voltage +1.8V typ.
- Low current consumption 2.3mA typ. @V_{CTL}=1.8V
- 10μA typ. @V_{CTL}=0V
- High gain 16.0dB typ. @V_{CTL}=1.8V, f_{RF}=942.5MHz
- Low noise figure 1.4dB typ. @V_{CTL}=1.8V, f_{RF}=942.5MHz
- Input power at 1dB gain compression point -8.5dBm typ. @V_{CTL}=1.8V, f_{RF}=942.5MHz
- +16.0dBm typ. @V_{CTL}=0V, f_{RF}=942.5MHz
- High input IP3 0dBm typ. @V_{CTL}=1.8V, f_{RF}=942.5MHz
- +14dBm typ. @V_{CTL}=0V, f_{RF}=942.5MHz
- Small package size USB6-A8 (Package size: 1.0mmx1.2mmx0.38mm typ.)
- Lead-free and halogen-free

■ PIN CONFIGURATION

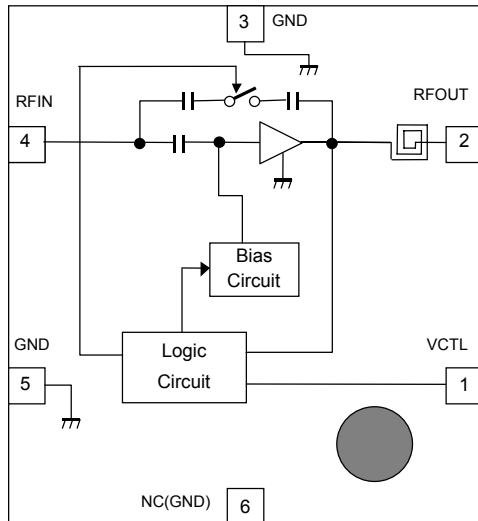

Pin Connection

1. VCTL
2. RFOUT
3. GND
4. RFIN
5. GND
6. NC (GND)

■ TRUTH TABLE

“H”=V_{CTL}(H), “L”=V_{CTL}(L)

VCTL	LNA Mode
H	High Gain Mode
L	Low Gain Mode

Note: Specifications and description listed in this datasheet are subject to change without notice.

NJG1138HA8

■ ABSOLUTE MAXIMUM RATINGS

$T_a=+25^{\circ}\text{C}$, $Z_s=Z_l=50\Omega$

PARAMETERS	SYMBOL	CONDITIONS	RATINGS	UNITS
Supply voltage	V_{DD}		5.0	V
Control voltage	V_{CTL}		5.0	V
Input power	P_{IN}		+15	dBm
Power dissipation	P_D	on PCB board, $T_{jmax}=150^{\circ}\text{C}$	150	mW
Operating temperature	T_{opr}		-40~+85	$^{\circ}\text{C}$
Storage temperature	T_{stg}		-55~+150	$^{\circ}\text{C}$

■ ELECTRICAL CHARACTERISTICS 1 (DC)

(General Conditions: $V_{DD}=2.8\text{V}$, $T_a=+25^{\circ}\text{C}$)

PARAMETERS	SYMBOL	CONDITIONS	MIN	TYP	MAX	UNITS
Operating voltage	V_{DD}		2.5	2.8	3.6	V
Control voltage (High)	$V_{CTL(H)}$	VCTL terminal	1.36	1.8	3.6	V
Control voltage (Low)	$V_{CTL(L)}$	VCTL terminal	0	0	0.3	V
Operating current1 (High Gain Mode)	I_{DD1}	RF OFF, $V_{CTL}=1.8\text{V}$	-	2.3	4.0	mA
Operating current2 (Low Gain Mode)	I_{DD2}	RFOFF, $V_{CTL}=0\text{V}$	-	10	45	μA
Control current	I_{CTL}	RF OFF, $V_{CTL}=1.8\text{V}$	-	5.5	8.5	μA

■ ELECTRICAL CHARACTERISTICS 2 (High Gain Mode)

(General Conditions: $V_{DD}=2.8V$, $V_{CTL}=1.8V$, $f_{RF}=942.5MHz$, $Z_S=Z_I=50\ \Omega$, $T_a=+25^\circ C$, with application circuit)

PARAMETERS	SYMBOL	CONDITIONS	MIN	TYP	MAX	UNITS
Small signal gain 1	Gain1	Exclude PCB and connector losses (input: 0.07dB, output: 0.07dB)	14.5	16.0	17.5	dB
Noise figure 1	NF1	Exclude PCB and connector losses (input:0.07dB)	-	1.4	1.7	dB
Input power at 1dB gain compression point 1	$P_{-1dB(IN)1}$		-16.0	-8.5	-	dBm
3rd order Input Intercept Point 1	IIP3_1	$f1=f_{RF}$, $f2=f_{RF}+100kHz$, $P_{in}=-30dBm$	-7.0	0	-	dBm
RF IN VSWR 1	$VSWR_I 1$		-	1.8	2.3	-
RF OUT VSWR 1	$VSWR_O 1$		-	2.2	2.7	-

■ ELECTRICAL CHARACTERISTICS 3 (Low Gain Mode)

(General Conditions: $V_{DD}=2.8V$, $V_{CTL}=0V$, $f_{RF}=942.5MHz$, $Z_S=Z_I=50\ \Omega$, $T_a=+25^\circ C$, with application circuit)

PARAMETERS	SYMBOL	CONDITIONS	MIN	TYP	MAX	UNITS
Small signal gain 2	Gain2	Exclude PCB and connector losses (input: 0.07dB, output: 0.07dB)	-4.5	-3.0	-2.0	dB
Noise figure 2	NF2	Exclude PCB and connector losses (input:0.07dB)	-	3.0	6.0	dB
Input power at 1dB gain compression point 1	$P_{-1dB(IN)2}$		+4.5	+16.0	-	dBm
3rd order Input Intercept Point 2	IIP3_2	$f1=f_{RF}$, $f2=f_{RF}+100kHz$, $P_{in}=-20dBm$	+2.0	+14.0	-	dBm
RF IN VSWR 2	$VSWR_I 2$		-	1.4	2.0	-
RF OUT VSWR 2	$VSWR_O 2$		-	1.6	2.2	-

NJG1138HA8

■ TERMINAL INFORMATION

No.	SYMBOL	DESCRIPTION
1	VCTL	Gain control port. Inputting a logic-high, the LNA turn at high gain mode. Inputting a logic-low, the LNA turn at low gain mode.
2	RFOUT	RF output terminal. Requires an external matching components. This terminal should be connected a DC blocking capacitor C1.
3	GND	Ground terminal. Connect to the PCB ground plane.
4	RFIN	RF input terminal. Requires an external matching components.
5	GND	Ground terminal. Connect to the PCB ground plane.
6	NC (GND)	No connected terminal. This terminal is not connected with internal circuit. Connect to the PCB ground plane.

Notes: Ground terminal (No.3 and 5) and NC terminal (No.6) should be connected with the PCB ground for good RF performance.

■ ELECTRICAL CHARACTERISTICS (High Gain Mode)

(General Conditions: $V_{DD}=2.8V$, $V_{CTL}=1.8V$, $f_{RF}=942.5MHz$, $Z_S=Z_L=50\ \Omega$, $T_a=+25^\circ C$, with application circuit)

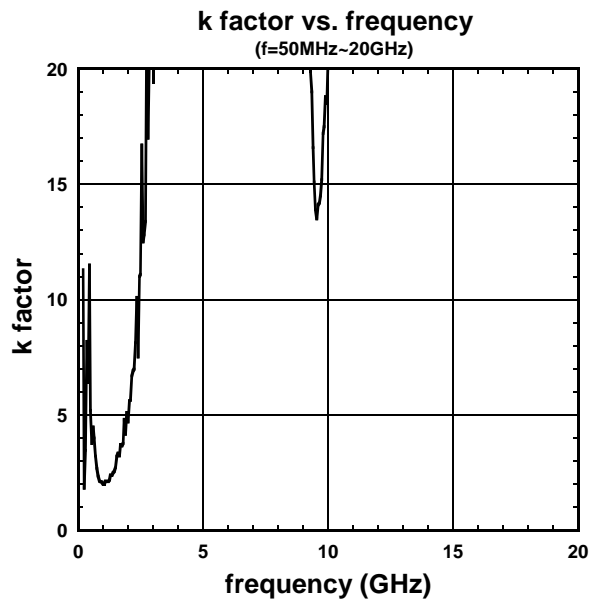
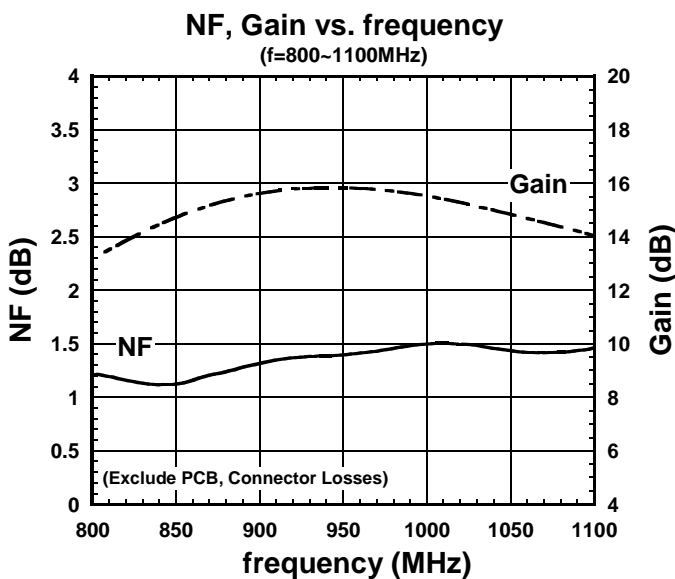
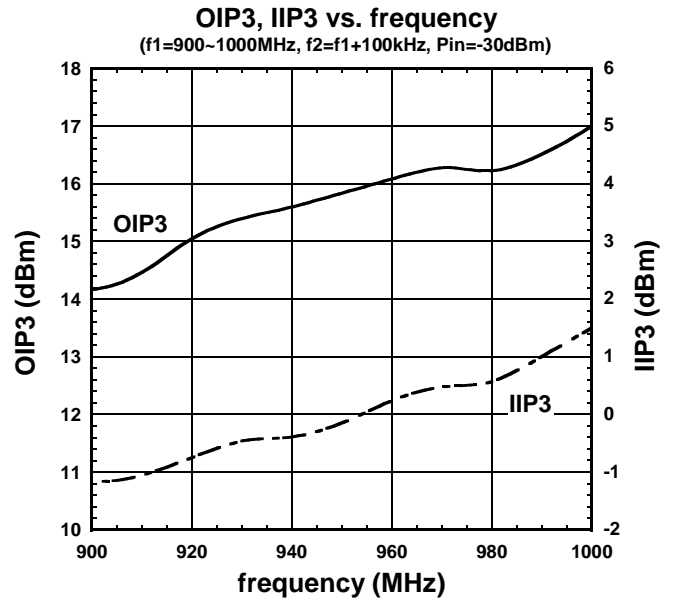
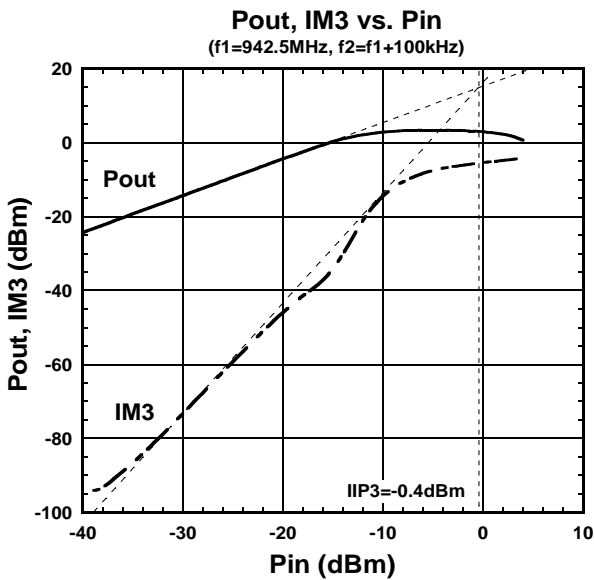
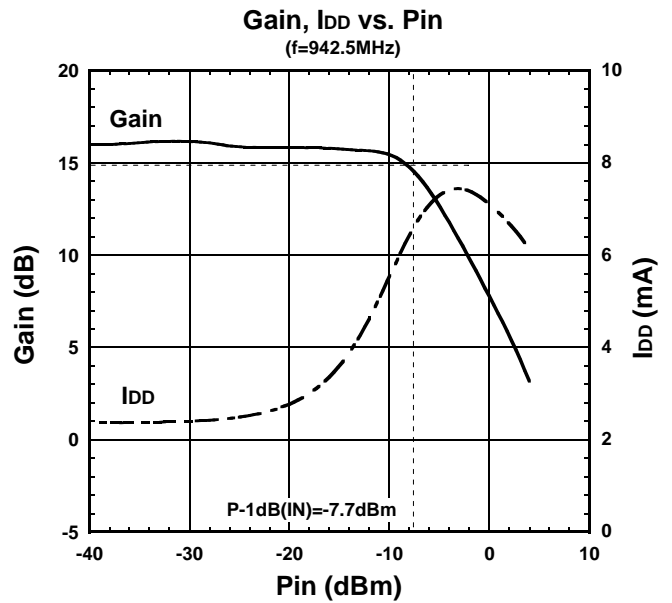
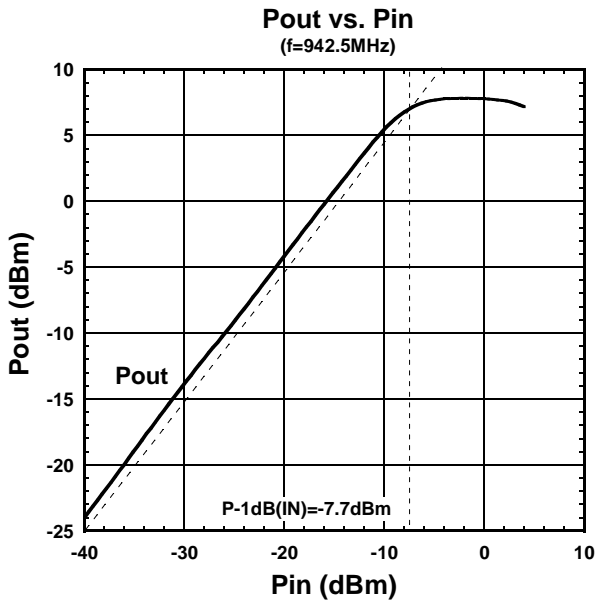

NJG1138HA8

■ ELECTRICAL CHARACTERISTICS (High Gain Mode)

(General Conditions: $V_{DD}=2.8V$, $V_{CTL}=1.8V$, $f_{RF}=942.5MHz$, $Z_s=Z_l=50\ \Omega$, $T_a=+25^\circ C$, with application circuit)

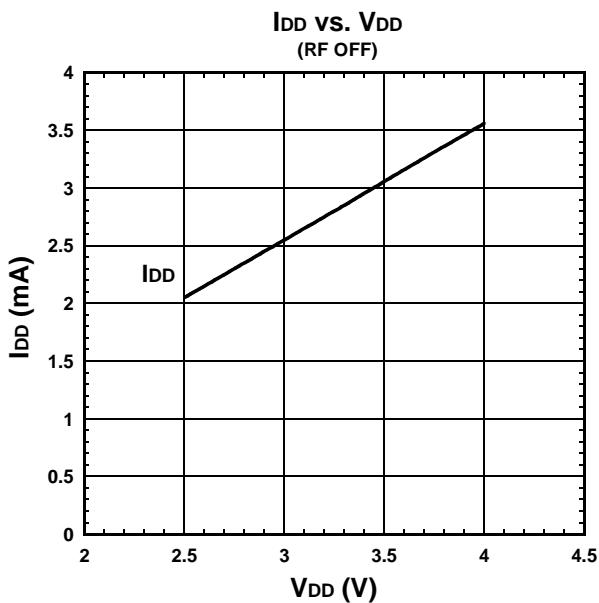
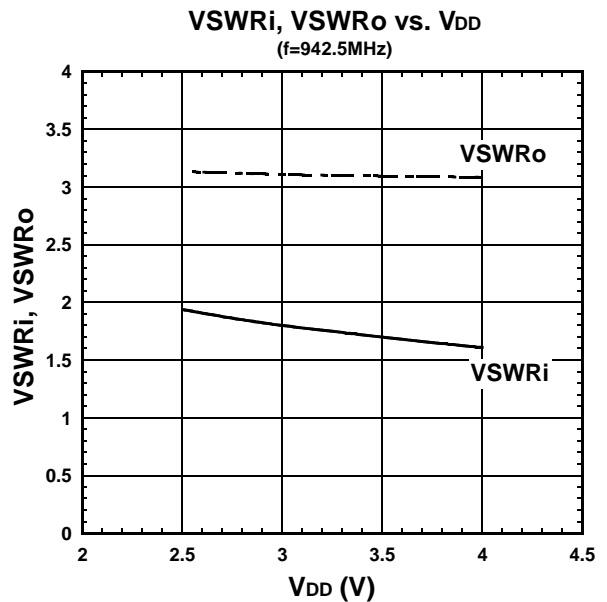
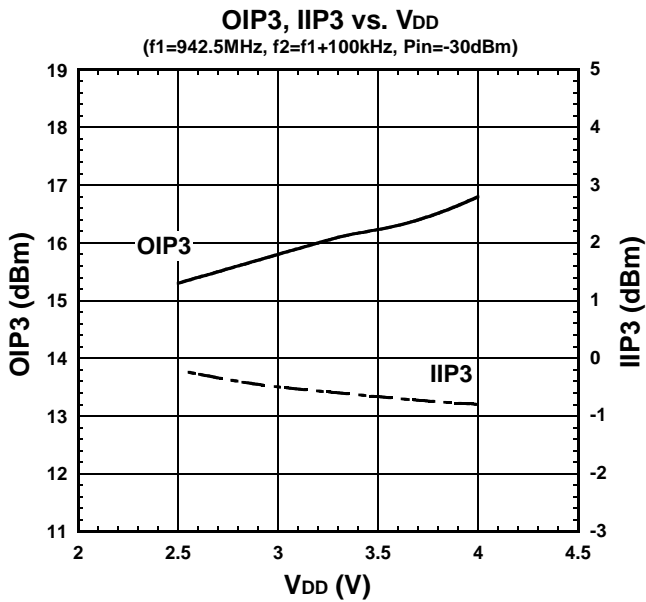
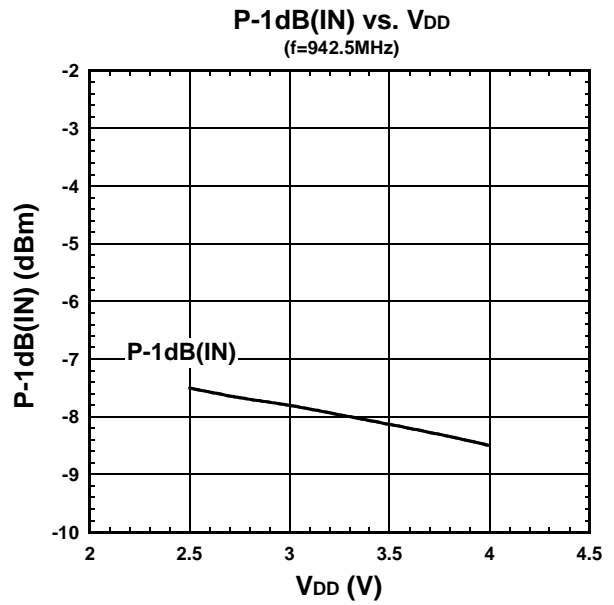
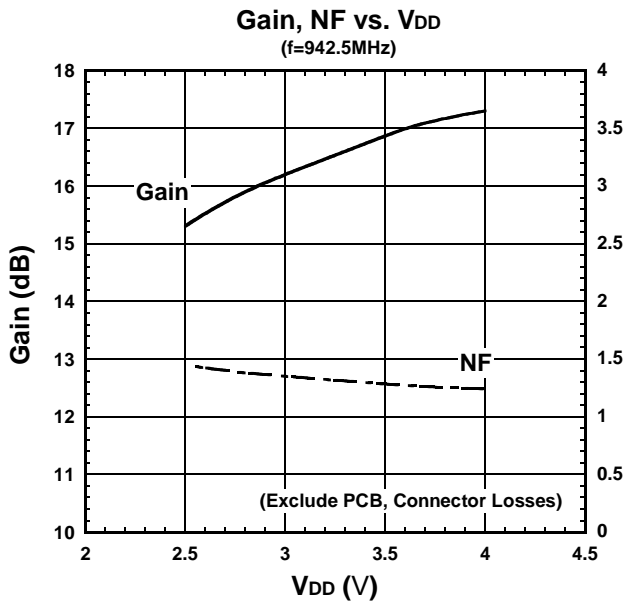

■ ELECTRICAL CHARACTERISTICS (High Gain Mode)

(General Conditions: $V_{DD}=2.8V$, $V_{CTL}=1.8V$, $f_{RF}=942.5MHz$, $Z_S=Z_L=50\ \Omega$, with application circuit)

Gain, NF vs. Temperature
($f=942.5MHz$)

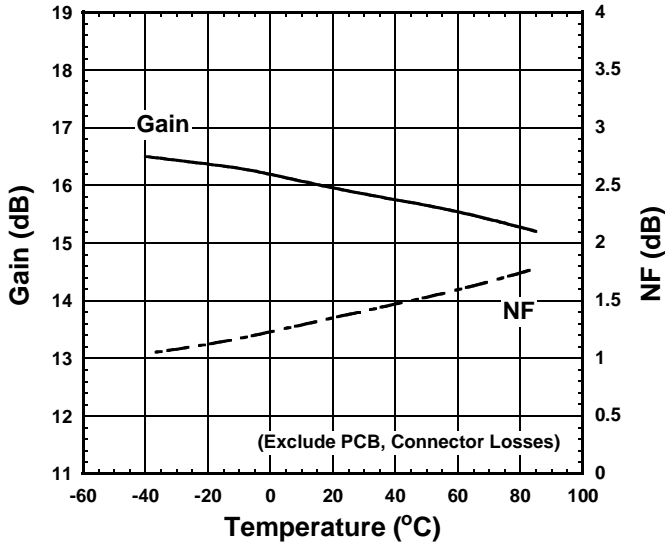

P-1dB(IN) vs. Temperature
($f=942.5MHz$)

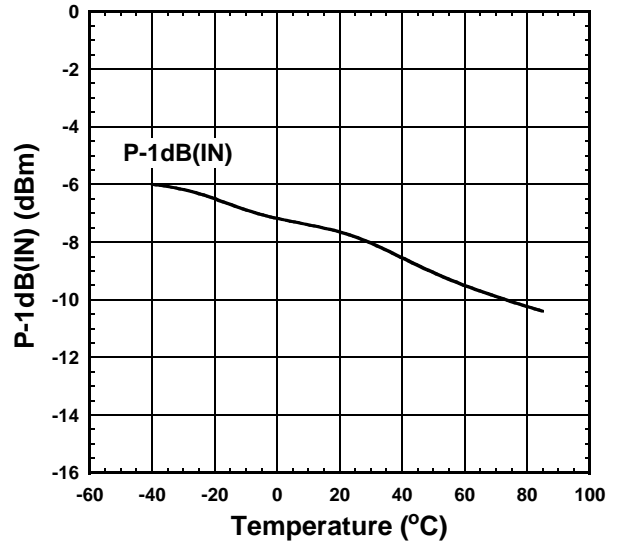

OIP3, IIP3 vs. Temperature
($f_1=942.5MHz$, $f_2=f_1+100kHz$, $P_{in}=-30dBm$)

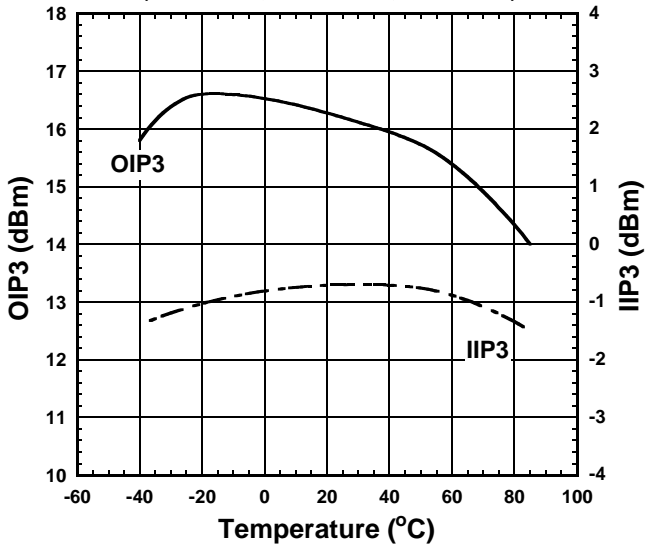

VSWRi, VSWRo vs. Temperature
($f=942.5MHz$)

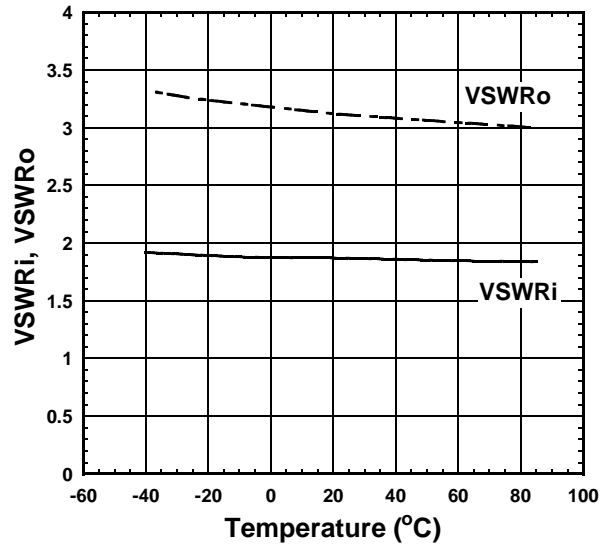

I_{DD} vs. Temperature
(RF OFF)

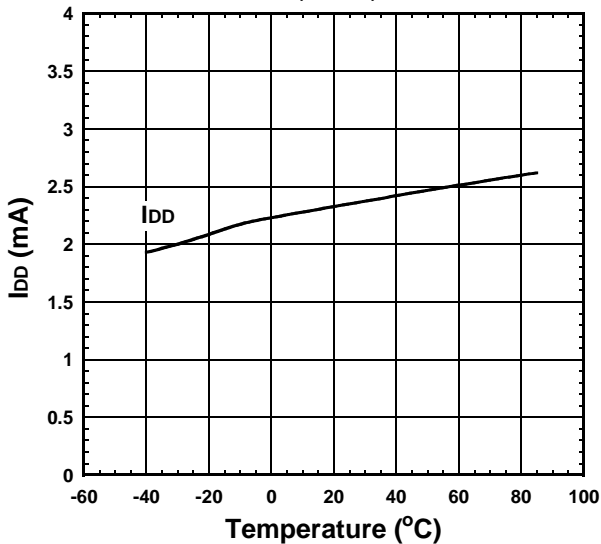

NJG1138HA8

ELECTRICAL CHARACTERISTICS (High Gain Mode)

(General Conditions: $V_{DD}=2.8V$, $V_{CTL}=1.8V$, $f_{RF}=942.5MHz$, $Z_s=Z_l=50\ \Omega$, $T_a=+25^\circ C$, with application circuit)

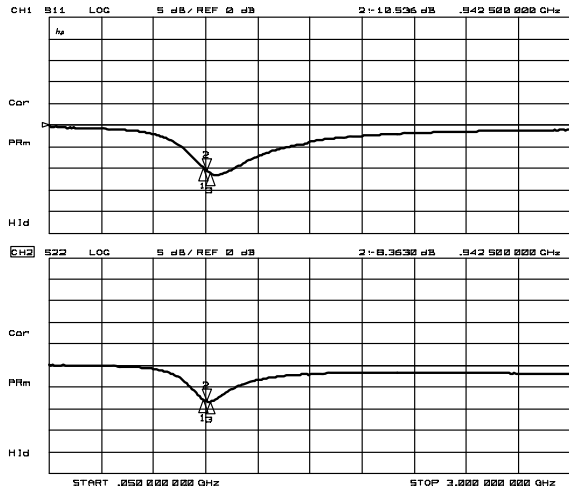

S11, S22

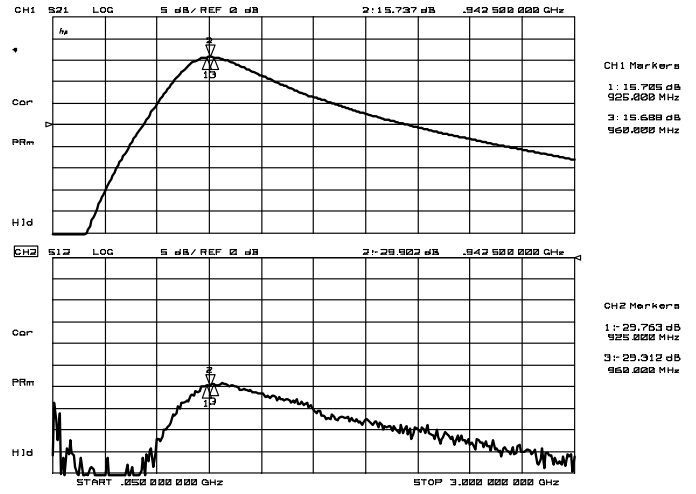

S21, S12

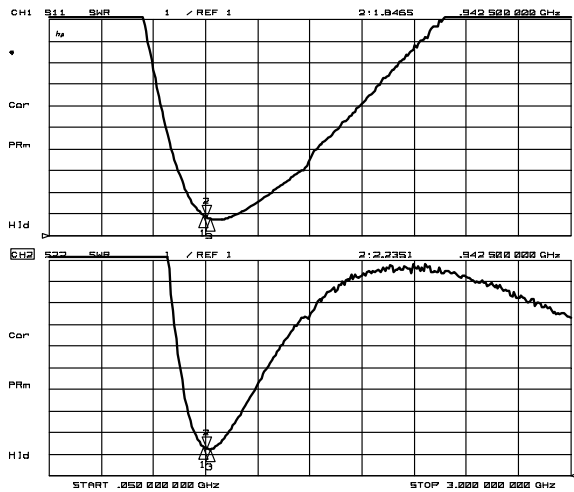

VSWR

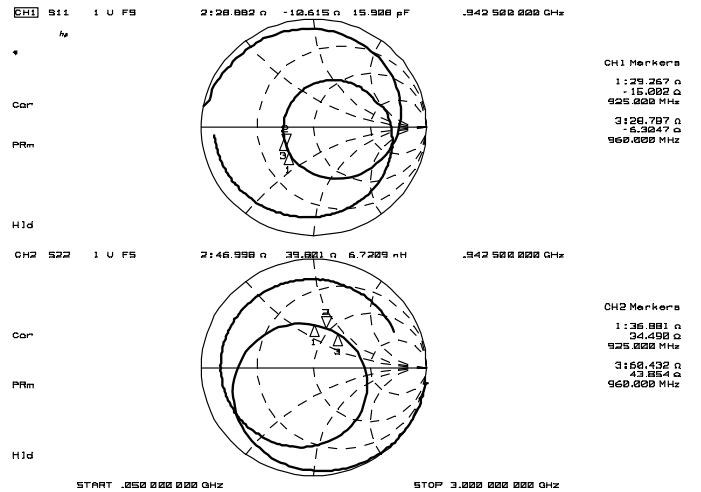

Zin, Zout

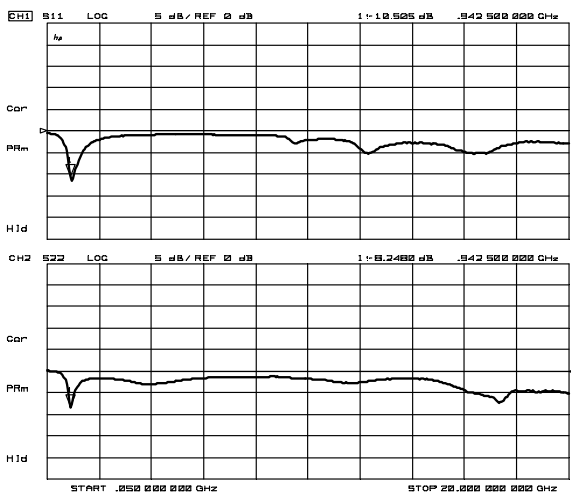

S11, S22
(f=50MHz~20GHz)

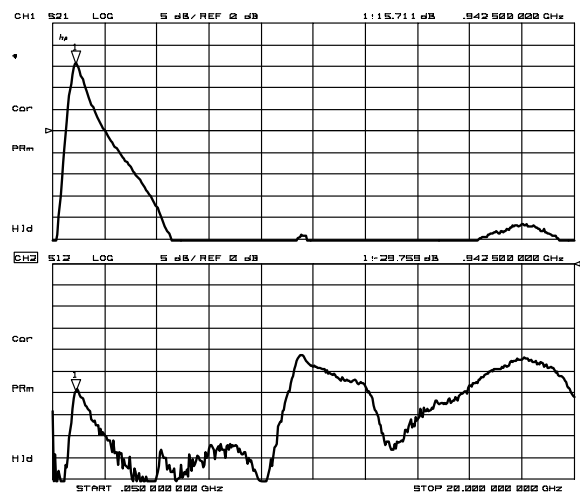

S21, S12
(f=50MHz~20GHz)

■ ELECTRICAL CHARACTERISTICS (Low Gain Mode)

(General Conditions: $V_{DD}=2.8V$, $V_{CTL}=0V$, $f_{RF}=942.5MHz$, $Z_S=Z_I=50\ \Omega$, $T_a=+25^\circ C$, with application circuit)

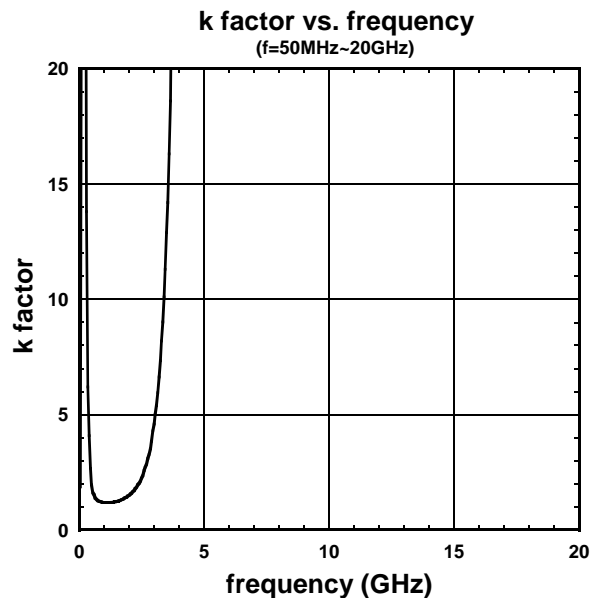
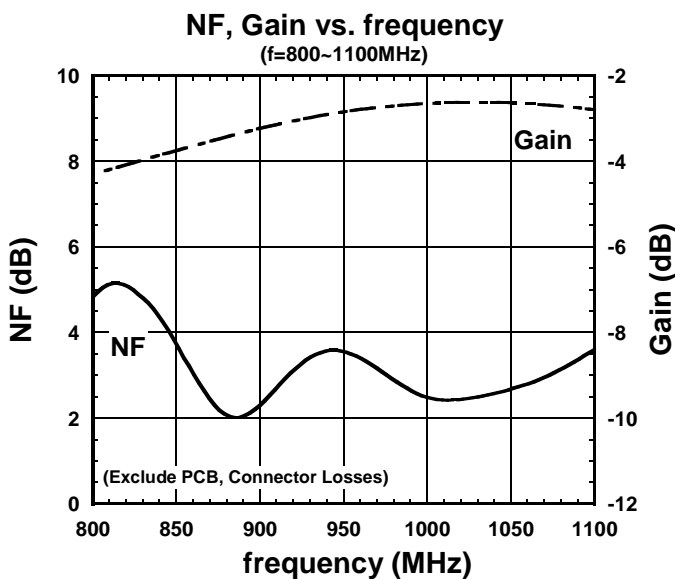
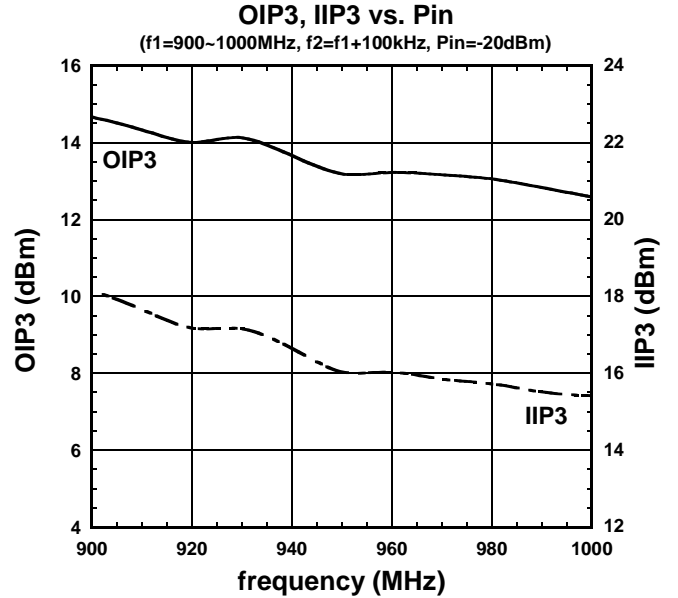
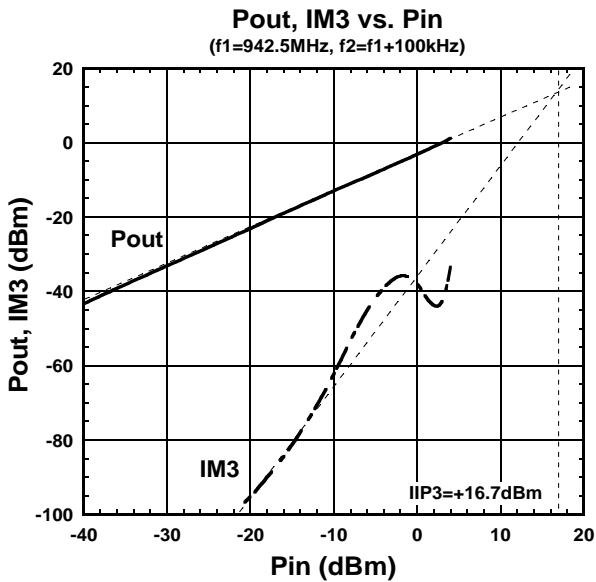
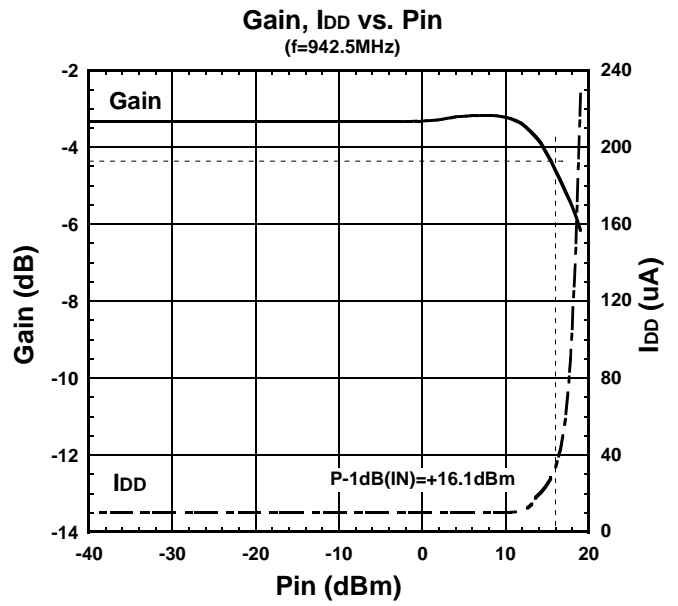
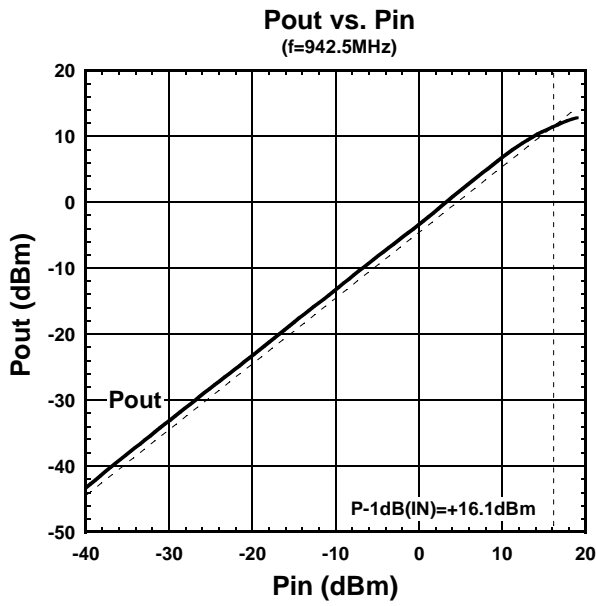

NJG1138HA8

■ ELECTRICAL CHARACTERISTICS (Low Gain Mode)

(General Conditions: $V_{DD}=2.8V$, $V_{CTL}=0V$, $f_{RF}=942.5MHz$, $Z_s=Z_l=50\ \Omega$, $T_a=+25^\circ C$, with application circuit)

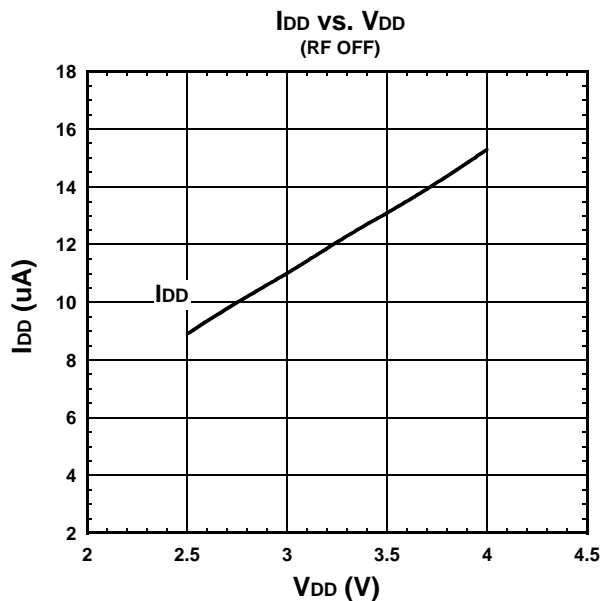
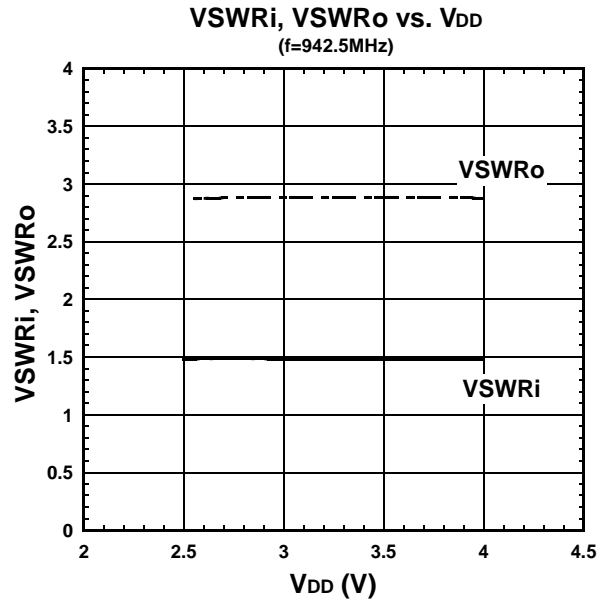
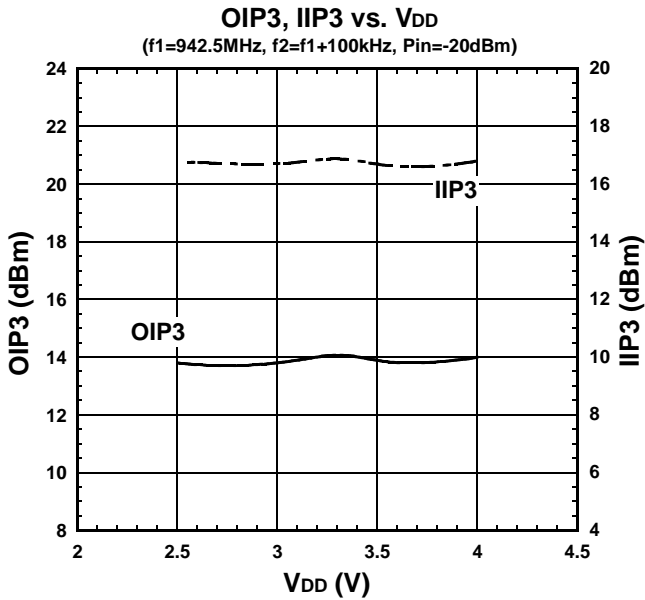
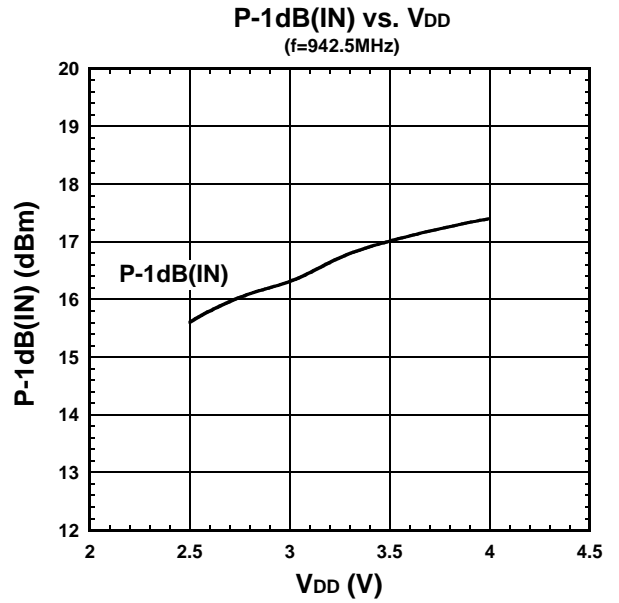
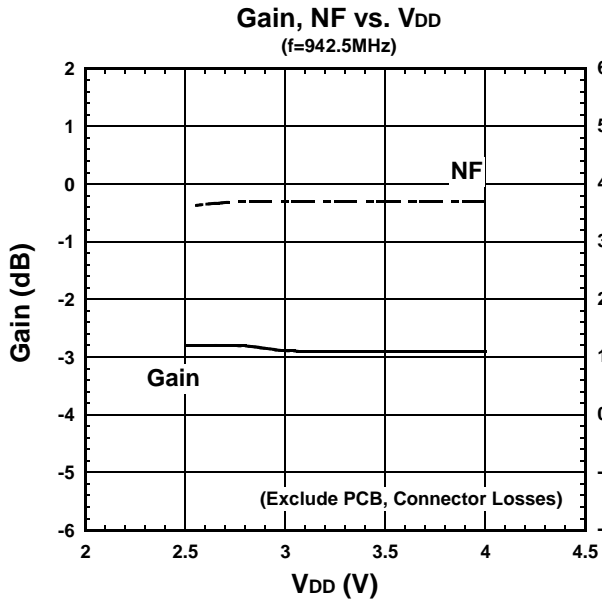

■ ELECTRICAL CHARACTERISTICS (Low Gain Mode)

(General Conditions: $V_{DD}=2.8V$, $V_{CTL}=0V$, $f_{RF}=942.5MHz$, $Z_s=Z_l=50\ \Omega$, with application circuit)

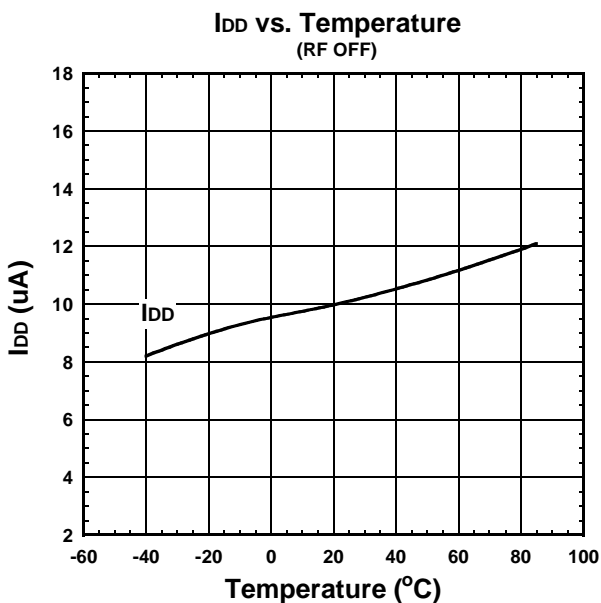
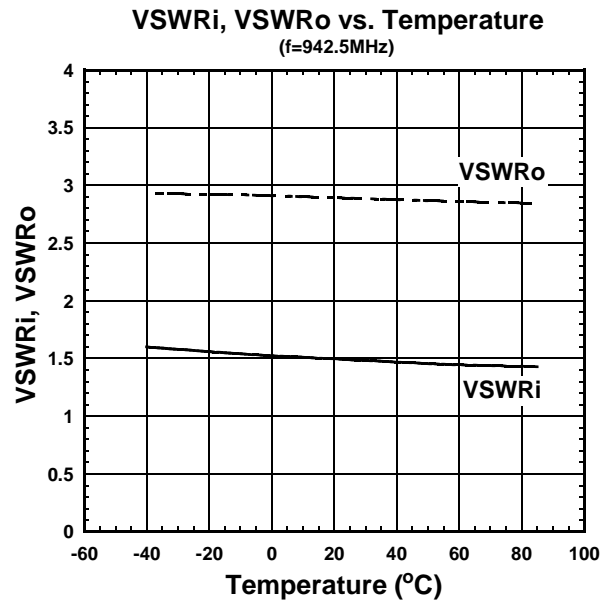
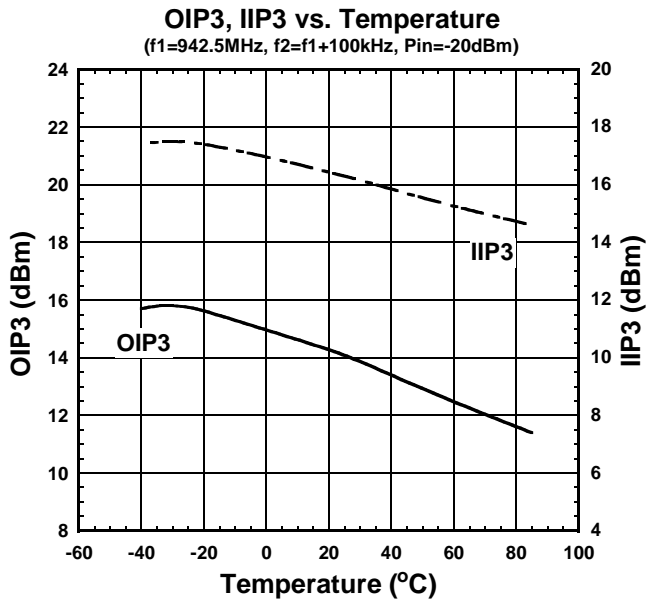
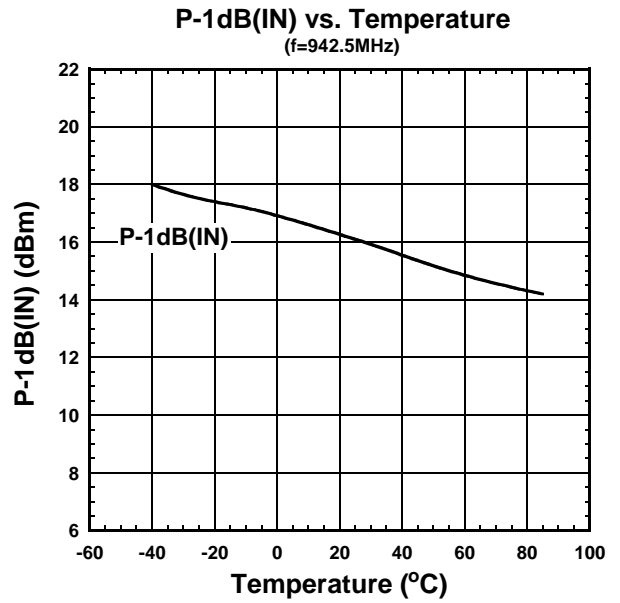
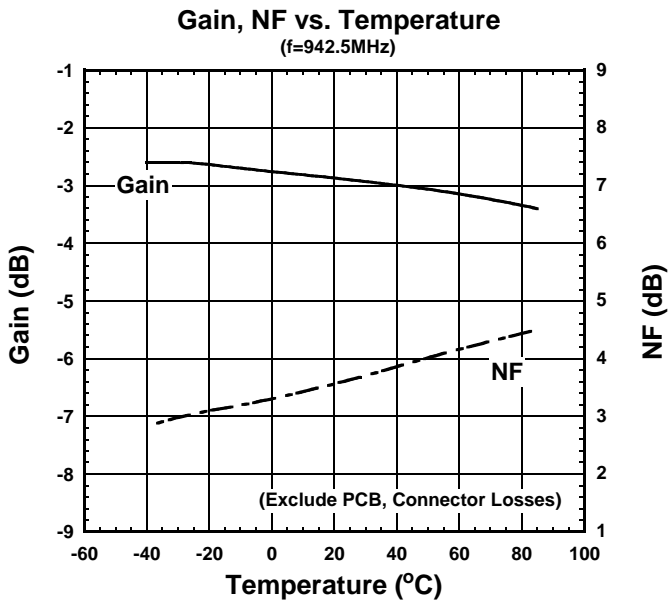

NJG1138HA8

ELECTRICAL CHARACTERISTICS (Low Gain Mode)

(General Conditions: $V_{DD}=2.8V$, $V_{CTL}=0V$, $f_{RF}=942.5MHz$, $Z_s=Z_l=50\ \Omega$, $T_a=+25^\circ C$, with application circuit)

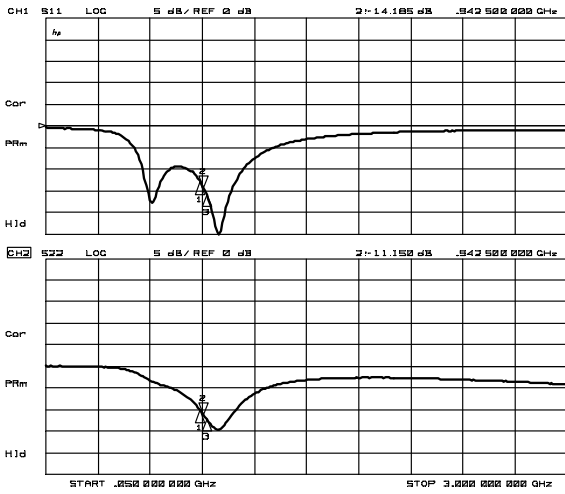

S11, S22

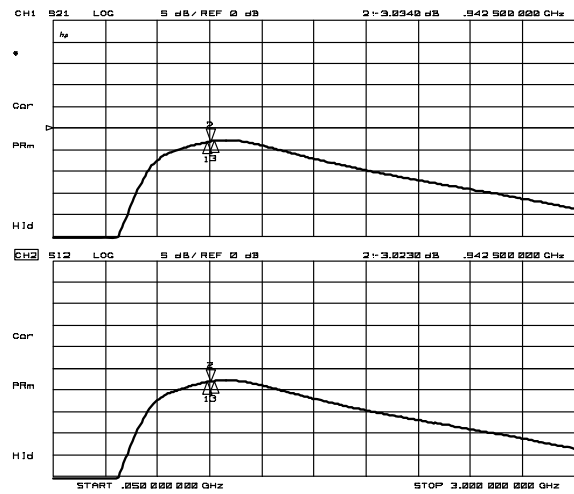

S21, S12

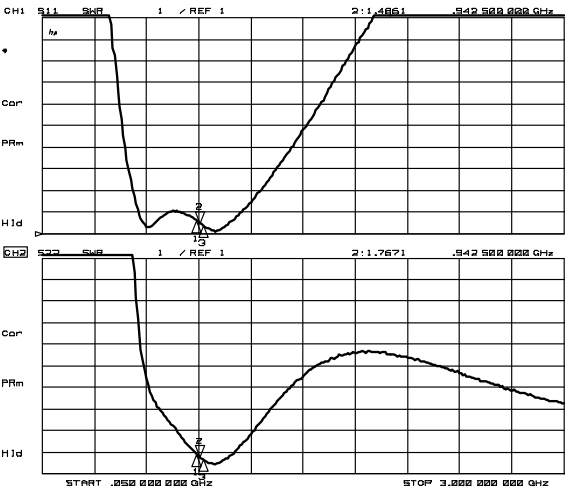

VSWR

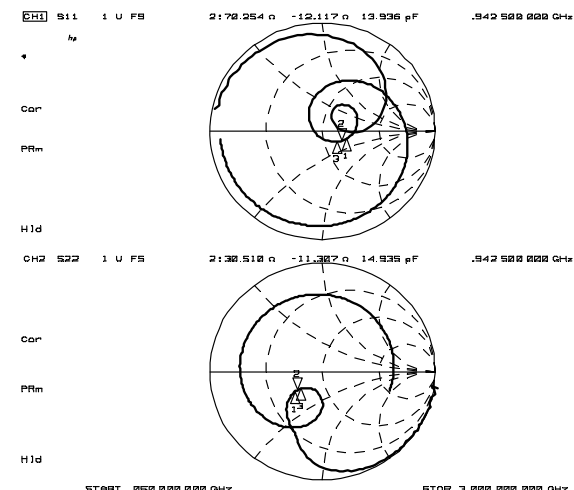

Zin, Zout

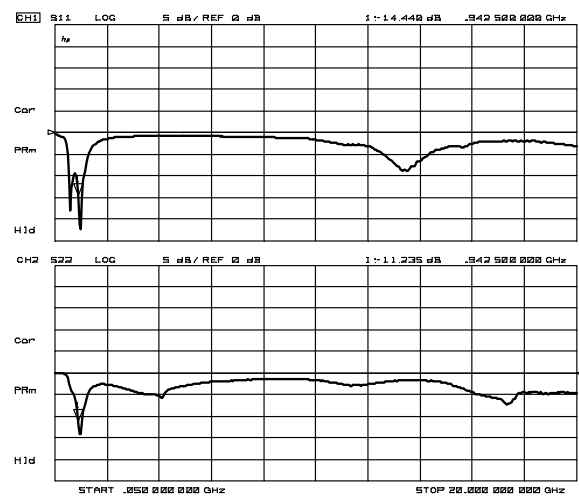

S11, S22
(f=50MHz~20GHz)

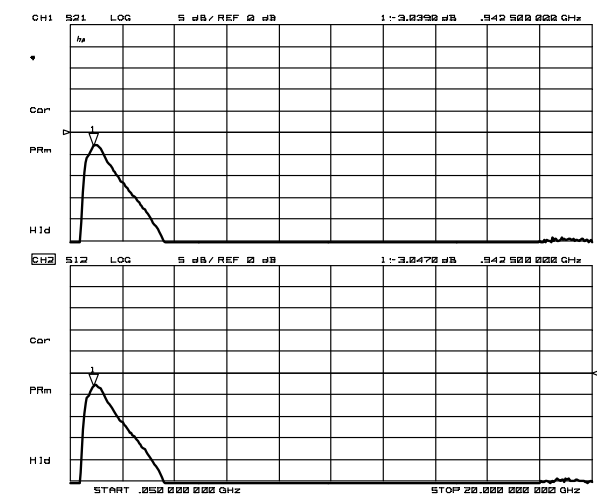

S21, S12
(f=50MHz~20GHz)

APPLICATION CIRCUIT

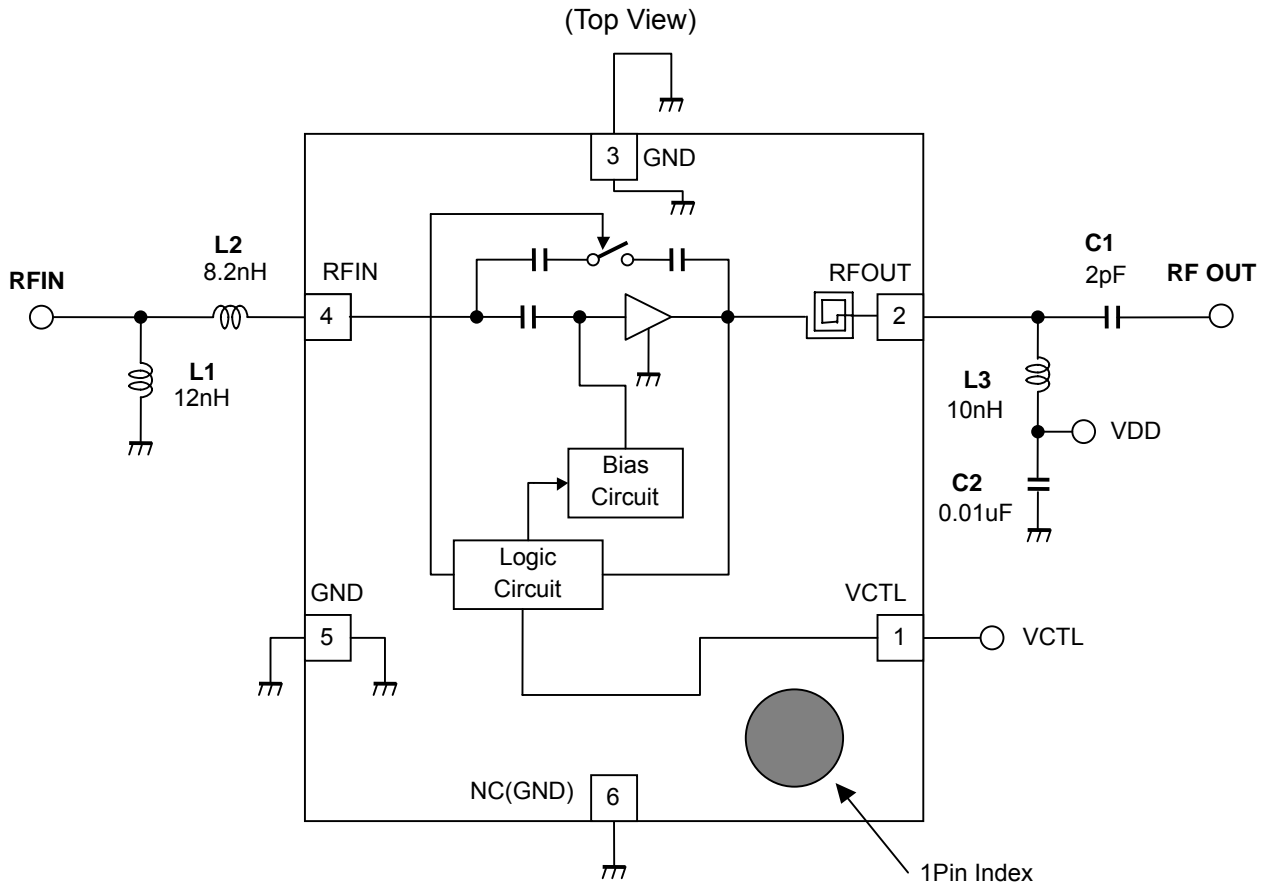

TEST PCB LAYOUT

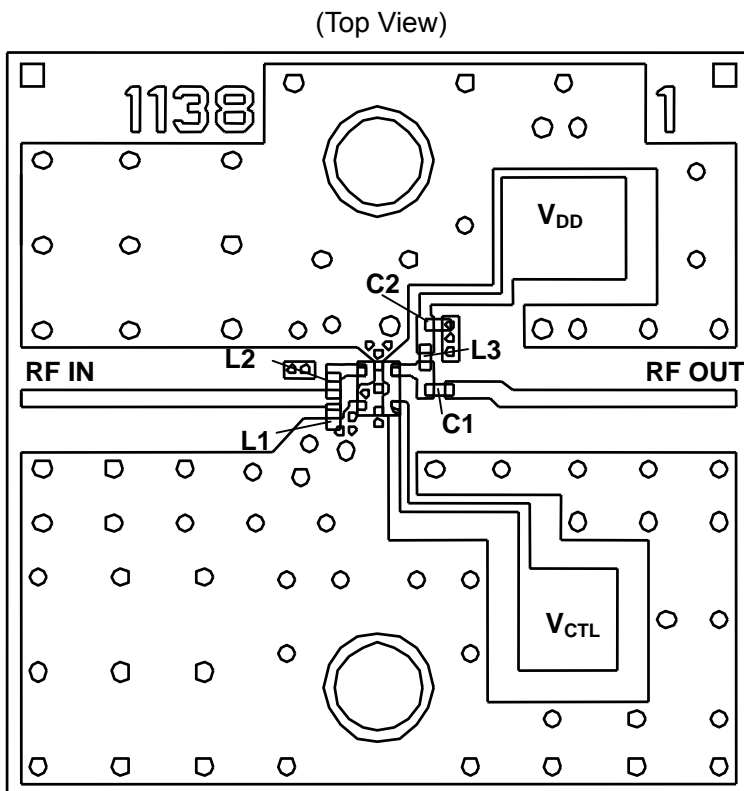

Parts ID	Comments
L1, L2	Murata LQP03T Series
L3	TDK MLK0603 Series
C1, C2	Murata GRM03 Series

PCB (FR-4):
 t=0.2mm
 MICROSTRIP LINE WIDTH
 =0.4mm ($Z_0=50\text{ohm}$)
 PCB SIZE=17.0mm x 17.0mm

NJG1138HA8

PACKAGE OUTLINE (USB6-A8)

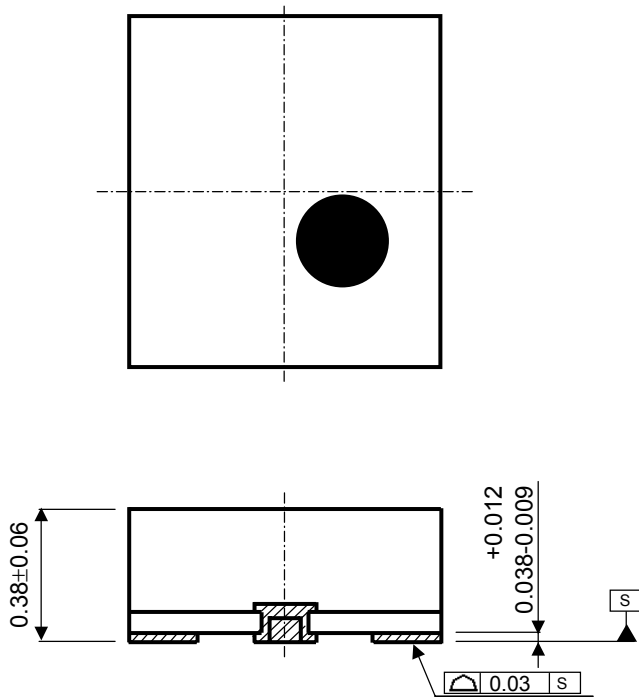

TERMINAL TREAT :Au
 Substrate :Glass epoxy
 Molding material :Epoxy resin
 UNIT :mm
 WEIGHT :1.1mg

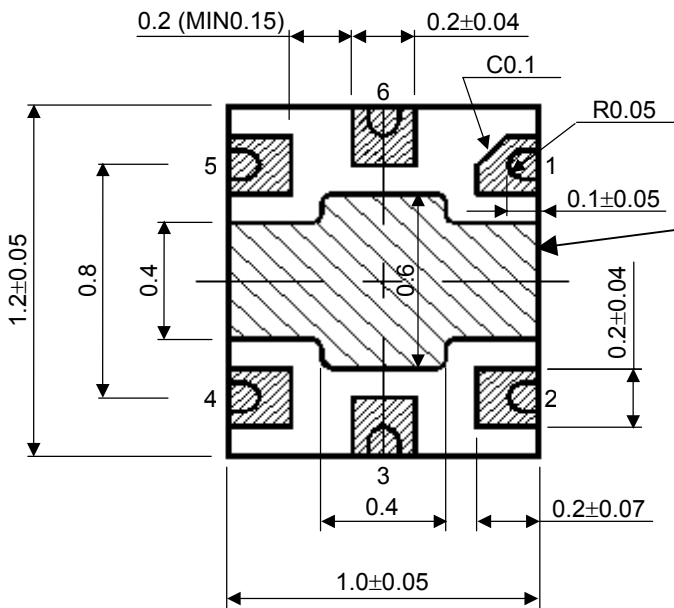
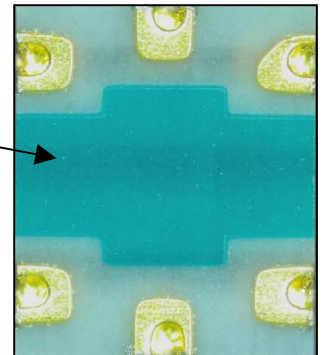

Photo resist coating



Cautions on using this product

This product contains Gallium-Arsenide (GaAs) which is a harmful material.

- Do NOT eat or put into mouth.
- Do NOT dispose in fire or break up this product.
- Do NOT chemically make gas or powder with this product.
- To waste this product, please obey the relating law of your country.

[CAUTION]

The specifications on this databook are only given for information, without any guarantee as regards either mistakes or omissions. The application circuits in this databook are described only to show representative usages of the product and not intended for the guarantee or permission of any right including the industrial rights.

This product may be damaged with electric static discharge (ESD) or spike voltage. Please handle with care to avoid these damages.