

PART NUMBER: AMT203**DESCRIPTION: 12 BIT ABSOLUTE ENCODER**

This encoder is a 12 bit absolute rotational encoder with SPI serial bus for working as a slave to an external microprocessor. Incremental A,B and Index signals are provided for high speed operation. The Index is one pulse per 22.5 degree (16 index per turn).

The encoder contains two channels of a capacitive encoder: a Fine channel and a Coarse channel. The Fine channel has 16 wavelengths of a periodic capacitive pattern, while the Coarse channel has 5 wavelengths. Each channel has its own ASIC that interpolates to a resolution of 256 increments per wavelength. A microprocessor on the encoder PCB is combining the two channels for a position reading that is absolute over a full turn with 12 bit resolution.

ELECTRONIC SPECIFICATIONS

parameter	conditions/description	min	nom	max	units
power supply		2.7	5	5.5	V
current consumption			8	10	mA
output resolution			1024		ppr
incremental output signals	A, B, Z phase				
incremental output waveform	square wave				
incremental outputs	output voltage - sourcing to +5 V @ -32 mA output voltage - sinking to ground @ -32 mA	3.8		0.55	V V
index output	one index pulse per 1/16 turn				
SPI output	natural binary				
SPI bus	PIC 16F690 (see datasheet)				
SPI resolution				12	bit

MECHANICAL SPECIFICATIONS









parameter	conditions/description	min	nom	max	units
output range				360	deg
SPI speed				8000	RPM
mounting hole options	A) 2 each M1.6 holes on 16 mm (0.63") bolt circle B) 2 each #4 holes on 19.05 mm (0.75") bolt circle C) 2 each M1.6 or M2 holes on 20 mm (0.787") bolt circle D) 3 each M1.6 or M2 holes on 20.9 mm (0.823") bolt circle E) 3 each M1.6 or M2 holes on 22 mm (0.866") bolt circle F) 4 each M1.6 or M2 holes on 25.4 mm (1") bolt circle G) 2 each #4 holes on 15.75 mm (0.62") x 20.96 (0.825") hole layout* H) 2 each #4 holes on 32.43 mm (1.277") bolt circle* I) 2 each #4 holes on 46.03 mm (1.812") bolt circle*				

ENVIRONMENTAL SPECIFICATIONS

parameter	conditions/description	min	nom	max	units
operating temperature		-25		85	°C
storage temperature		-40		100	°C
humidity			85		%RH
vibration	1.5mm, 3 directions, 2 hours	10		55	Hz

PART NUMBER: AMT203
DESCRIPTION: 12 BIT ABSOLUTE ENCODER
AMT203-V KIT

In order to provide maximum flexibility for our customers, the AMT203 series is provided in kit form standard. This allows the user to implement the encoder into a range of applications using one sku#, reducing engineering and inventory costs.

SLEEVES								
								
8mm	1/4 inch (6.35mm)	6mm	5mm	3/16 inch (4.76mm)	4mm	1/8 inch (3.175mm)	3mm	2mm
Blue	Snow	Red1	Green1	Yellow1	Gray60	Purple1	Orange	Light Sky Blue

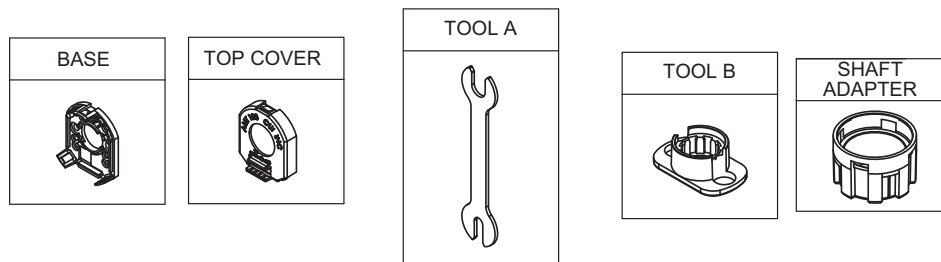
CUSTOM CONFIG KEY

For customers that prefer a specific AMT203 configuration, please reference the custom configuration key below.

AMT203 - XXXX

Sleeve Bore Diameter:
 2000 = 2 mm
 2300 = 2.3 mm
 3000 = 3 mm
 3175 = 3.175 mm (1/8")
 4000 = 4 mm
 4760 = 4.76 mm (3/16")
 5000 = 5 mm
 6000 = 6 mm
 6350 = 6.35 mm (1/4")
 8000 = 8 mm

PART NUMBER: AMT203
DESCRIPTION: 12 BIT ABSOLUTE ENCODER
Connection to customer electronics

 10 lead ribbon cable: Power (2); SPI (4); Quadrature (2); Index (1); Zero set (1)
 Output lines can drive 20 mA.

#	color	function
1	black	T bit
2	white	IDX
3	grey	A or Count
4	purple	B or Udn
5	blue	MOSI
6	green	5V
7	yellow	SCK
8	orange	Ground
9	red	MISO
10	brown	CSN

IDX
 B or UDN
 5V
 Ground
 CSN

1

A or Count

MOSI

SCK

MISO

T bit
 A or Count
 MOSI
 SCK
 MISO

Tyco connector 1658621-1

Encoder Side

Demo Board Side

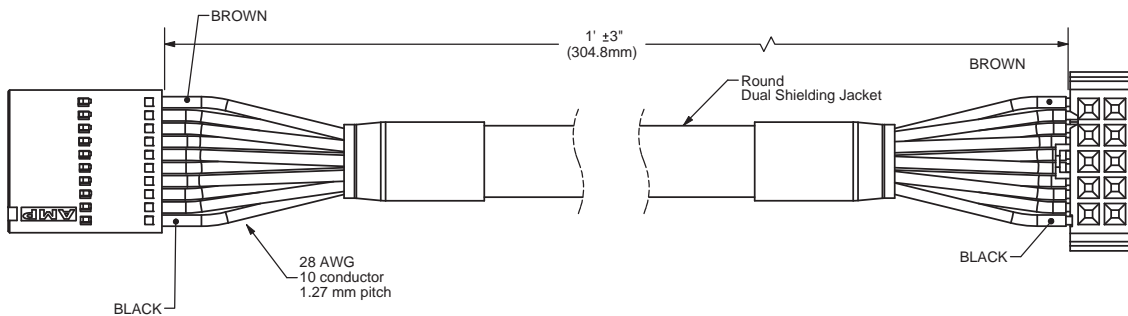
3659-10-1FT-DMBD Demo Board Cable

(Cable available without Demo Board Connector)

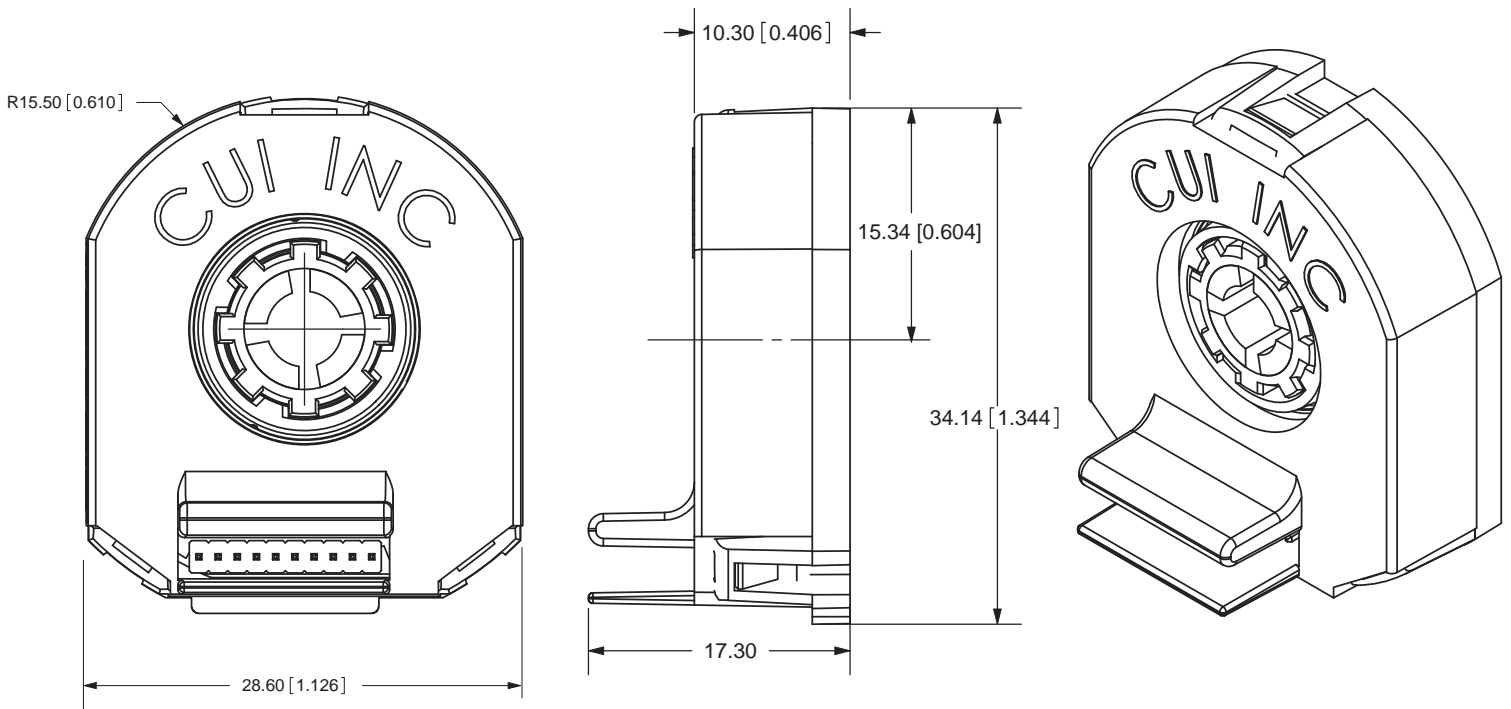
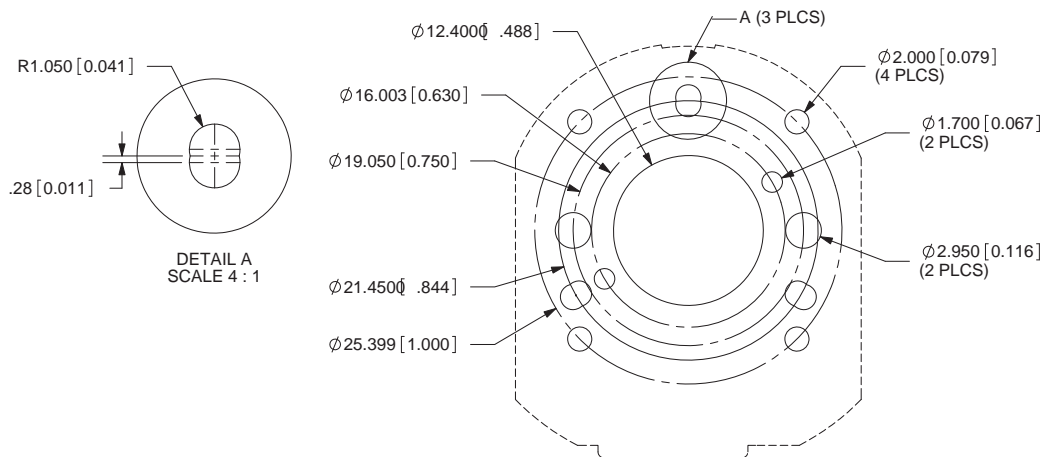
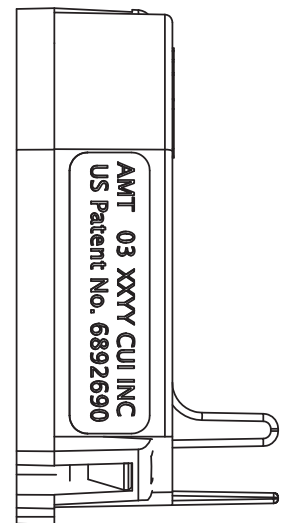
PART NUMBER: AMT203
DESCRIPTION: 12 BIT ABSOLUTE ENCODER

MOUNTING BASE

 TOLERANCE:
 ±0.05mm UNLESS OTHERWISE
 SPECIFIED

PART NUMBER: AMT203
DESCRIPTION: 12 BIT ABSOLUTE ENCODER

APPLICATION NOTES

Encoder operational mode

- **Initiation mode:** At power up the encoder starts by doing:
 - Coarse channel measurement
 - Fine channel measurement
 - Combine fine with coarse for ABS position (natural binary)
 The above takes about 1 ms. After this, the encoder switches to continuous operation.
- **Tracking mode:** Only the Fine channel is active and the MCU internal position register is updated with data from Fine:
 - MCU 12 bit position register is updated from Fine every 125 μ s.
 - The MCU position register can be lagging up to 120 μ s from the real position. This error is proportional to speed: $e < 0.75 \text{ deg/1k(rpm)}$.
 - The MCU is able to follow up to speeds of 8000 RPM and recover to full accuracy when speed slows down.
 - For accurate position update without above time delay, outputs for incremental A quad B or Count and Up/Dwn from the Fine channel are provided. These outputs are operational up to 8000 RPM and there is no speed error. There is an acceleration error dependent on an internal filter constant of about 100 μ s.
 - When using the incremental output there also is an Index output available, with one index pulse per 1/16 turn.
- **Initiation mode** can be repeated at standstill on command from the master MCU in the application.
 - Loop time ~1 ms.

Serial Peripheral Interface Commands

The SPI or Serial Peripheral Interface Bus is a standard interface promoted by Motorola and Microchip among others. It consists of 4 signals:

- MOSI: Master Out Slave In
- MISO: Master In Slave Out
- SCK: Serial Clock
- CSB: Chip Select Bar (active low)

SPI BUS

The SPI bus runs full duplex and transfers multiples of 8 bits in a frame. The SPI type is the most common (CPOL=0, CPHA=0), also known as Microwire. Data is captured on the rising edge of SCK and the output data is changed after the falling edge of SCK.

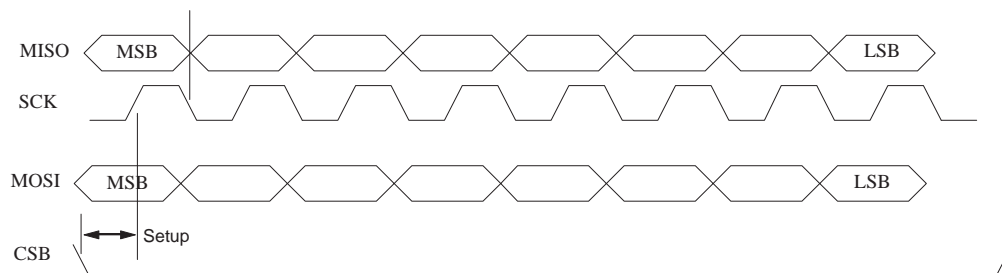

Serial Peripheral Interface Bus (SPI) on AMT1025

PART NUMBER: AMT203**DESCRIPTION: 12 BIT ABSOLUTE ENCODER**

Figure 7: SPI BUS Timing Diagram

The MSB data out on MISO is valid soon after CSB goes low. The MOSI data is valid soon after the falling edge of SCK. The Encoder drives data out on MISO as long as CSB is low.

Normally, CSB goes low, then after 8 clocks the command is interpreted. CSB high resets the clock counter, and terminates any command sequence.

SPI Commands:

The commands are all 8 bits long, the MSB is shifted in first, and is the leftmost bit shown in the documentation.

Encoder Protocol Considerations:

The Encoder is designed to operate with a high speed SPI link, in full duplex mode. This implies the host can issue commands and read data as quickly as necessary but there has to be an acknowledgement from the slave just before the data is transferred.

Essentially the host issues a command, receives zero or more wait sequences (0xA5 or 1010,0101) then the echo of the command followed by an optional payload.

So, for example to read the position, the host issues rd_pos (0x10 or 0001,0000), receiving a series of wait sequences (0xA5) then a reflected rd_pos (0x10), then the MSB data followed by the LSB data.

It is recommended that the host leave a 20 us gap between reads to avoid extending the read time by forcing wait sequences.

Command 0x00: nop_a5

This command is ignored by the Encoder and simply causes the next data to be read. The encoder responds with 0xA5 if there is nothing else to send.

Command 0x10: rd_pos

This command causes a read of the current position.

The sequence is as follows:

- 1) issue read command, receive idle character
- 2) issue NOP, receive idle character 0xA5 or 0x10
- 3) repeat step 2 if it is 0xA5
- 4) issue NOP and receive MSB position
- 5) issue NOP and receive LSB position

Note that it is possible to overlap commands, so instead of NOP is several steps above the user could start another operation. The read and write FIFOs for the PCI streams are 16 bytes long and it is up to the user to avoid overflow.

PART NUMBER: AMT203**DESCRIPTION: 12 BIT ABSOLUTE ENCODER****Comand 0x50: init_cal_md**

This command causes the encoder to enter calibration mode. In this mode the coarse and fine devices are repeatedly read and the position is recalculated. The period for reading these devices is about 500 microseconds each since the transmitters have to be turned on and off and the devices have to stabilize before reading.

Comand 0x60: norm_md

This command causes the encoder to go back to normal tracking mode.

Command 0x70: set_zero_point

This command sets the current position to zero and saves this setting in the EEPROM. The host should send nop_a5 repeatedly after sending this command, the response will be 0xa5 while update is proceeding and eeprom_wr is the response when update is finished.

Comand 0x80,<byte_address>,<data>: eeprom_wr

This command causes the data to be written to the address given in <byte_address>. The address can be 0x00 to 0x7f for 128 bytes of data.

Comand 0x81,<ctl_code>,<data>: ctl_eeprom_wr

This command causes the <data> byte to be written to the offset given in <ctl_code>. Only certain offsets are valid: 0xFF is the coarse adjust for the absolute position calculation (default 6), 0xFD is the MSB offset for zero adjustment (default 0), 0xFE is the LSB offset for zero adjustment (default 0).

Comand 0x90,<byte_address>,0x01: eeprom_rd

This command causes the data in eeprom at the given address to be read and put in the output fifo.

The sequence is as follows:

- 1) issue read command, receive idle character
- 2) issue NOP, receive idle character or 0x90 (echo of read command)
- 3) repeat step 2 if it is an idle character
- 4) issue NOP and receive

PART NUMBER: AMT203**DESCRIPTION: 12 BIT ABSOLUTE ENCODER**

DATA Sampling:

Position data is read from the AMT devices inside the encoder every 120 μ s; it takes approximately 30 μ s to transfer a byte of information so the breakdown is:

- 1) issue sample command: 30 μ s
- 2) read 2 bytes of data: 60 μ s
- 3) calculate, add zero offset, and save position: 30 μ s

The position inside the AMT device is sampled at the end of step 1, and it is 0 to 25 μ s delayed at that point. So the data inside the microprocessor is 95 to 120 μ s delayed from the actual rotor position.

The SPI interface is capable of 2 MHz operation, and the data read operation consists of a command byte followed by 3 or 4 byte read operations; this is 12 to 16 μ s at the 2 MHz interface speed.

So there is a delay of 95 to 120 μ s for the data to be ready, and a delay of 12 or more μ s for the user to transfer data from the encoder interface.