

**PLEASE CHECK WWW.MOLEX.COM FOR LATEST PART INFORMATION**

**Part Number:** [0366380001](#)  
**Status:** **Active**  
**Overview:** [cmc connectors](#)  
**Description:** 2.50mm (.098"), 3.50mm (.138") CMC Header, Right Angle, 96 Position, 72 loaded, 2 Port, Black and Brown, Lead-free

**Documents:**

[3D Model](#) [RoHS Certificate of Compliance \(PDF\)](#)  
[Drawing \(PDF\)](#)

**General**

Product Family	PCB Headers
Series	<a href="#">36638</a>
Application	Wire-to-Board
Overview	<a href="#">cmc connectors</a>
Product Name	CMC

**Physical**

Breakaway	No
Circuits (Loaded)	72
Circuits (maximum)	96
Circuits Detail	12 x 1.5mm & 60 x 0.635mm terminals
Color - Resin	Black
Durability (mating cycles max)	20
First Mate / Last Break	Yes
Glow-Wire Compliant	No
Guide to Mating Part	Yes
Keying to Mating Part	Yes
Lock to Mating Part	No
Mated Height (in)	0.264 In
Mated Height (mm)	6.70 mm
Material - Metal	Brass
Material - Plating Mating	Tin
Material - Plating Termination	Tin
Material - Resin	Polyester
Number of Rows	4
Orientation	Right Angle
PC Tail Length (in)	0.114 In
PC Tail Length (mm)	2.90 mm
PCB Locator	No
PCB Retention	None
PCB Thickness Recommended (in)	0.031 In, 0.063 In
PCB Thickness Recommended (mm)	0.80 mm, 1.60 mm
Packaging Type	Tray
Pitch - Mating Interface (in)	0.098 In, 0.138 In, 0.146 In
Pitch - Mating Interface (mm)	2.50 mm, 3.50 mm, 3.70 mm
Pitch - Term. Interface (in)	0.098 In, 0.138 In, 0.146 In
Pitch - Term. Interface (mm)	2.50 mm, 3.50 mm, 3.70 mm
Plating min: Mating (µin)	160
Plating min: Mating (µm)	4
Plating min: Termination (µin)	160
Plating min: Termination (µm)	4
Polarized to Mating Part	Yes
Polarized to PCB	Yes
Shrouded	Closed Ends
Stackable	No

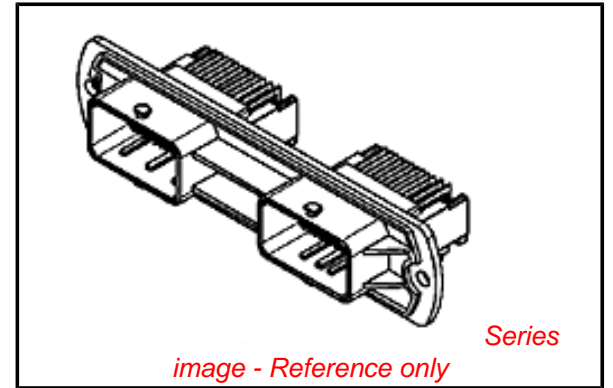

**EU RoHS**

**ELV and RoHS  
Compliant**  
**REACH SVHC  
Contains SVHC: No**  
**Halogen-Free  
Status**

**China RoHS**



**Need more information on product  
environmental compliance?**

Email [productcompliance@molex.com](mailto:productcompliance@molex.com)  
For a multiple part number RoHS Certificate of Compliance, [click here](#)

Please visit the [Contact Us](#) section for any non-product compliance questions.

**Search Parts in this Series**

[36638Series](#)

**Mates With**

CMC Connectors [643201311](#) , [643201319](#)

**Use With**

CMC Connectors [643201311](#) , [643201319](#).  
CMC CP Terminals [64322](#) , [64323](#). CMC  
Blind Plug for CP Terminal [64325](#). Wire Cap  
[643191201](#)

Surface Mount Compatible (SMC)	No
Temperature Range - Operating	-40°C to +100°C
Termination Interface: Style	Through Hole

**Electrical**

Current - Maximum per Contact	8A
Voltage - Maximum	250V

**Material Info****Reference - Drawing Numbers**

Packaging Specification	PK-36638-001, PK-36638-002
Sales Drawing	SD-36638-001

This document was generated on 05/24/2010

**PLEASE CHECK [WWW.MOLEX.COM](http://WWW.MOLEX.COM) FOR LATEST PART INFORMATION**

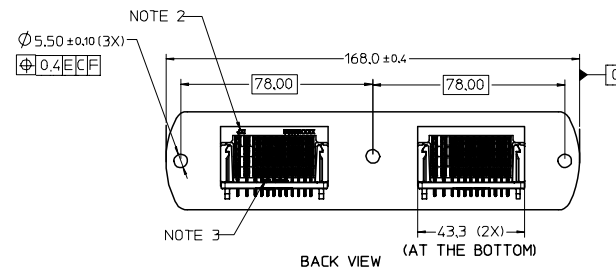
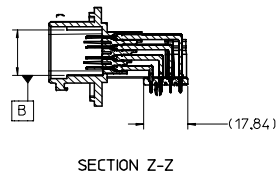
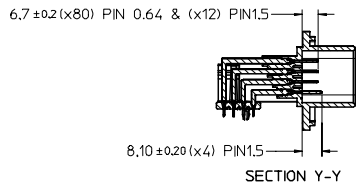
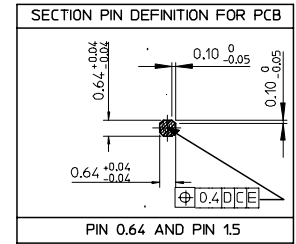
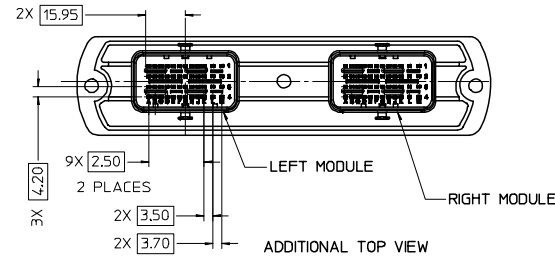
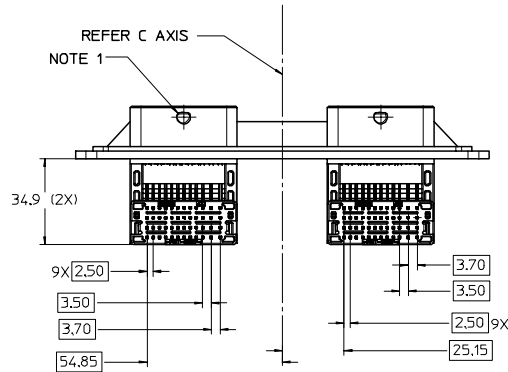
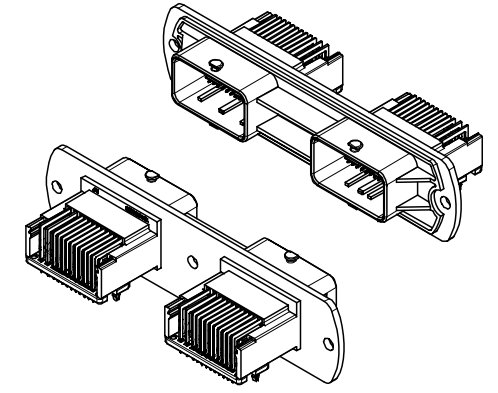
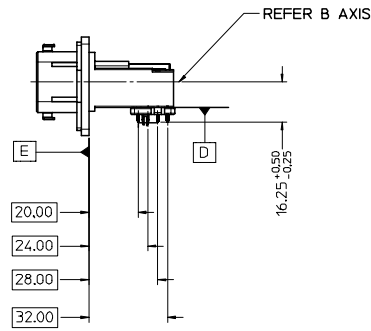
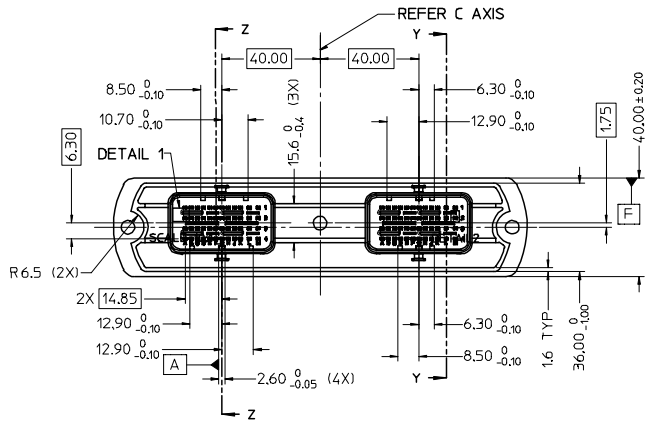

RoHS COMPLIANT

<b>ENTER DESCRIPTION</b> ELCAL: 2007-0937 DRAWING APPROVED: 2007/06/12 CHECKED BY: CHIKKOKUMAR APPROVED BY: APPR:CHIKKOKUMAR 2007/07/11	<b>QUALITY SYMBOLS</b> ▽=0 ▽=0	<b>GENERAL TOLERANCES (UNLESS SPECIFIED)</b>		<b>DIMENSION STYLE</b> MM ONLY	<b>SCALE</b> 1:1	<b>DESIGN UNITS</b> METRIC	<input checked="" type="checkbox"/> THIRD ANGLE PROJECTION	
		4 PLACES ± --- ± ---	.mm    .INCH	DRAWN BY DKUMAR	DATE 20/12/2005	TITLE CMC HEADER T3 INTERFACE - BK & BR 96/72 AND 96/96		
		3 PLACES ± --- ± ---	± 0.1	CHECKED BY XPRASAD	DATE 20/12/2005	APPROVED BY GJLOWE	DATE 20/12/2005	MOLEX INCORPORATED
		2 PLACES ± 0.1 ± ---	± 0.2	APPROVED BY GJLOWE	DATE 20/12/2005	MATERIAL NO. SEE TABLE	DOCUMENT NO. SD-36638-001	SHEET NO. 1 OF 3
DRAFT WHERE APPLICABLE MUST REMAIN WITHIN DIMENSIONS		ANGULAR ± 1°		THIS DRAWING CONTAINS INFORMATION THAT IS PROPRIETARY TO MOLEX INCORPORATED AND SHOULD NOT BE USED WITHOUT WRITTEN PERMISSION				

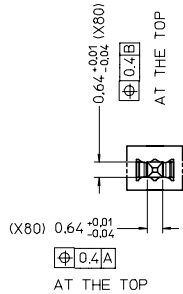
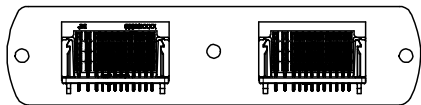
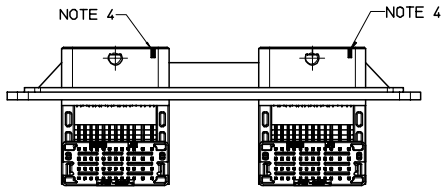

DETAIL 1  
SCALE 10:1

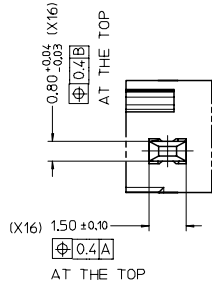

DETAIL 2  
SCALE 10:1

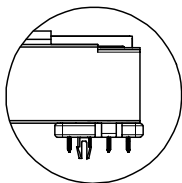
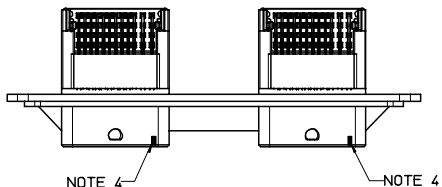

96/96 OR 96/72 CMC HEADER  
WITH PCB SNAP LOCKING

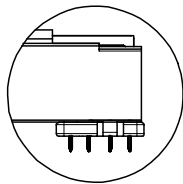

96/96 OR 96/72 CMC HEADER  
WITHOUT PCB SNAP LOCKING

36638-0012	CMC HEADER, T3-BR & BN, WITH PCB SNAP LOCK, 96/96	BROWN	BLACK	L1 & M1 L2 & M2 L3 & M3 L4 & M4	A1 TO H1, J1 & K1 A2 TO H2, J2 & K2 A3 TO H3, J3 & K3 A4 TO H4, J4 & K4	D
36638-0011	CMC HEADER, T3-BR & BN, W/O PCB SNAP LOCK, 96/96			C		
36638-0010	CMC HEADER, T3-BR & BN, WITH PCB SNAP LOCK, 96/72	BROWN	BLACK	L2 & M2 L3 & M3 L4 & M4	A2 TO H2, J2 & K2 A3 TO H3, J3 & K3 A4 TO H4, J4 & K4	B
36638-0001	CMC HEADER, T3-BR & BN, W/O PCB SNAP LOCK, 96/72			A		
MOLEX PART NO.	PART DISCRPTION	LEFT MODULE	RIGHT MODULE	15 PIN	0.64 PIN	PCB LAYOUT TO BE REFERRED
		COLOUR CODE		CAVITIES TO BE USED		

5	GRID PLATE WITH PCB LOCK	PBT 30% GLASS FILLED	BLACK	0	2	0	2
4	GRID PLATE W/O PCB LOCK		BLACK	2	0	2	0
3	HOUSING		BLACK	1	1	1	1
2	PIN 1.50	CuZn30	NICKEL UNDERCOAT: 1.3µM TO 2.2µM	12	12	16	16
1	PIN 0.64	CuZn30	MATTE TIN OVERCOAT: 4µM TO 5µM	60	60	80	80
SL.NO	DESIGNATION	MATERIAL	FINISH	BOM QUANTITY			
				36638-0001	36638-0010	36638-0011	36638-0012

NOTE:

1. PAINT BROWN PAINT[RoHS COMPLIANT] AT THE SPECIFIED AREA OF LEFT MODULE ON BOTH SIDES
2. AREA FOR JXI AND MOLEX PART NUMBER REPRESENTATION.
3. AREA FOR PLASTIC MATERIAL >PBT-30%GF< DESCRIPTION.
4. PAINT WITH WHITE COLOR[RoHS COMPLIANT] AT SPECIFIED FOUR AREAS
5. PART TO MEET SOLDERABILITY SPEC SMES-152
6. PACKAGNG SPECIFICATION: PK-36638-001

RoHS COMPLIANT

<b>ENTER DESCRIPTION</b> ELC.MC.12007.0037 O DRAWING APPR 2007/06/12 CHKDR KUMAR 2007/06/12 APPR KUMAR 2007/07/11	<b>QUALITY SYMBOLS</b> ▽=0 ▽=0	<b>GENERAL TOLERANCES (UNLESS SPECIFIED)</b> .mm INCH		<b>DIMENSION STYLE</b> MM ONLY		SCALE 1:1	DESIGN UNITS METRIC	THIRD ANGLE PROJECTION	
		4 PLACES ± .1 3 PLACES ± .1 2 PLACES ± 0.2 1 PLACE ± 0.2	± .1 ± .1 ± .1 ± .1	DRAWN BY DKUMAR DATE 20/12/2005	CHECKED BY XPRASAD DATE 20/12/2005	TITLE CMC HEADER T3 INTERFACE - BK & BR 96/72 AND 96/96		APPROVED BY GJLOWE DATE 20/12/2005	MATERIAL NO. SD-36638-001
DRAFT WHERE APPLICABLE MUST REMAIN WITHIN DIMENSIONS			SIZE A 1		THIS DRAWING CONTAINS INFORMATION THAT IS PROPRIETARY TO MOLEX INCORPORATED AND SHOULD NOT BE USED WITHOUT WRITTEN PERMISSION				

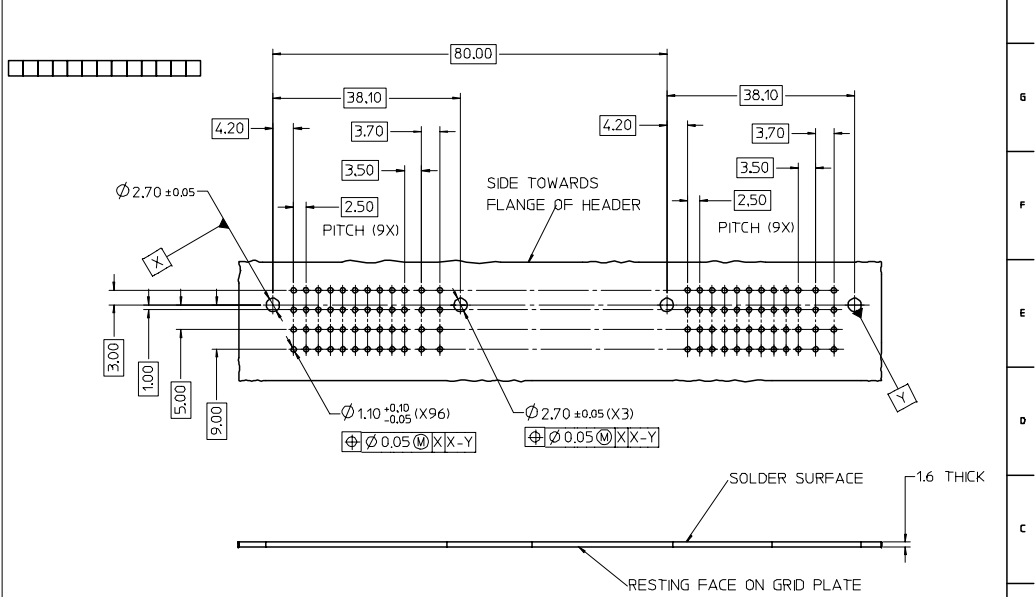
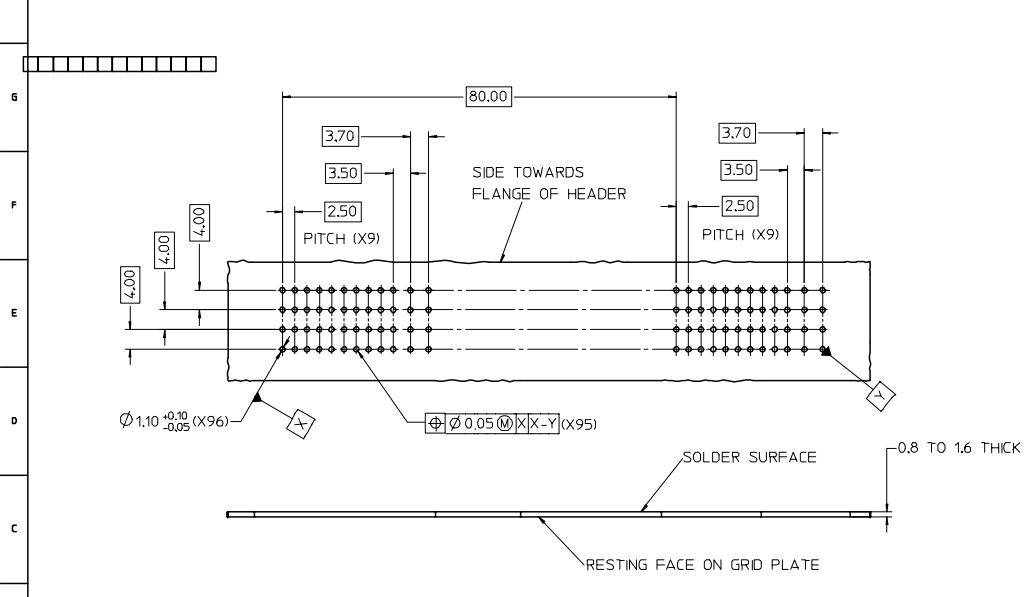
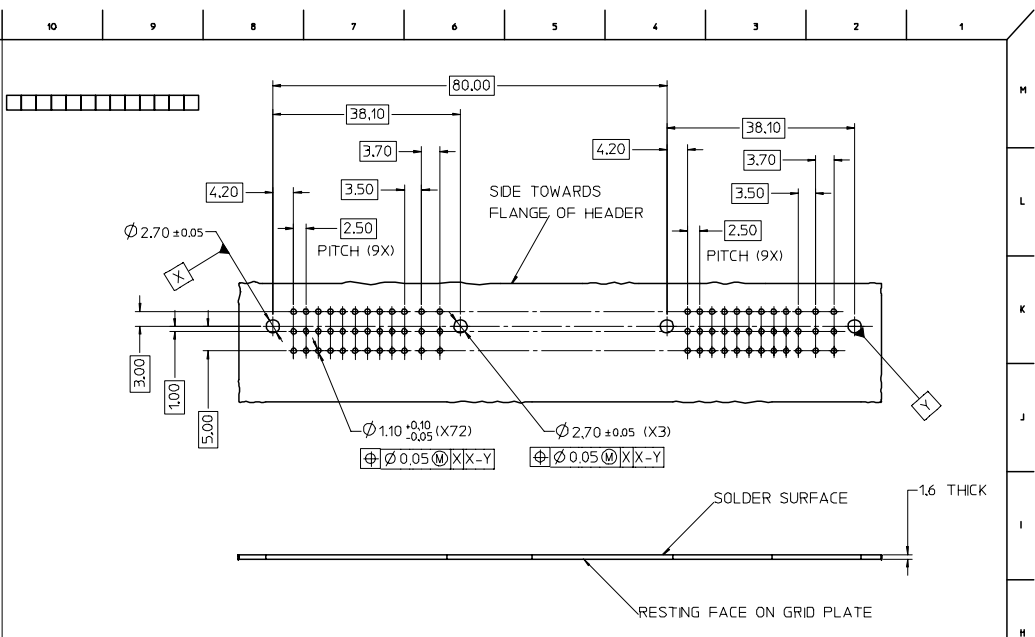
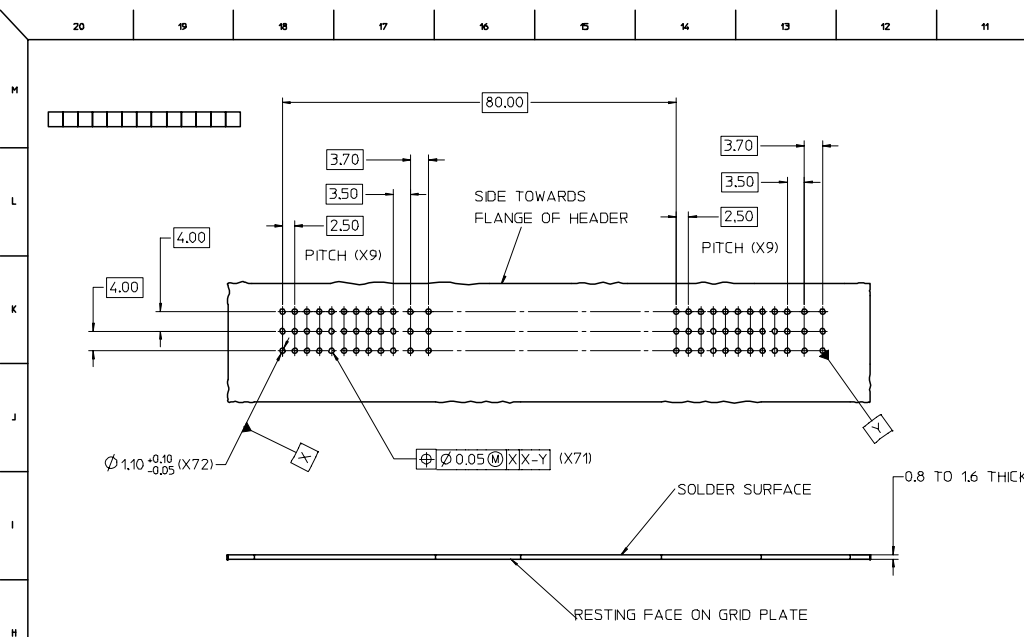

RoHS COMPLIANT

<b>ENTER DESCRIPTION</b> ELCAL: 2007-0937 DRAWING: 2007-0937 CHECKED BY: GJKDKUMAR APPROVED BY: GJKDKUMAR	<b>QUALITY SYMBOLS</b> ▽=0 ▽=0	<b>GENERAL TOLERANCES (UNLESS SPECIFIED)</b>		<b>DIMENSION STYLE</b> MM ONLY		SCALE: 2:1	DESIGN UNITS: METRIC	THIRD ANGLE PROJECTION	
		4 PLACES ± --- ± ---	INCH	DRAWN BY: DKUMAR DATE: 20/12/2005	TITLE: CMC HEADER T3 INTERFACE - BK & BR 96/72 AND 96/96				
		3 PLACES ± --- ± ---	INCH	CHECKED BY: KPRASAD DATE: 20/12/2005	MOLEX MOLEX INCORPORATED				
		2 PLACES ± 0.1 ± ---	INCH	APPROVED BY: GJLOWE DATE: 20/12/2005	MATERIAL NO.: SD-36638-001 DOCUMENT NO.: SHEET NO.: 3 OF 3				
1 PLACE ± 0.2 ± ---		INCH	ANGULAR ± 1°		DRAFT WHERE APPLICABLE MUST REMAIN WITHIN DIMENSIONS				
SIZE: A1		THIS DRAWING CONTAINS INFORMATION THAT IS PROPRIETARY TO MOLEX INCORPORATED AND SHOULD NOT BE USED WITHOUT WRITTEN PERMISSION							