

**PLEASE CHECK WWW.MOLEX.COM FOR LATEST PART INFORMATION**

**Part Number:** [0511910500](#)  
**Status:** **Active**  
**Description:** 2.50mm (.098") Pitch Wire-to-Wire and Wire-to-Board Receptacle Housing, With Guide Rails, 5 Circuits

**Documents:**

<a href="#">3D Model</a>	<a href="#">Product Specification PS-51191-003 (PDF)</a>
<a href="#">Drawing (PDF)</a>	<a href="#">RoHS Certificate of Compliance (PDF)</a>
<a href="#">Product Specification PS-51191-002 (PDF)</a>	

**Agency Certification**

UL	E29179
----	--------

**General**

Product Family	Crimp Housings
Series	<a href="#">51191</a>
Product Name	N/A

**Physical**

Circuits (maximum)	5
Flammability	94V-0
Gender	Female
Glow-Wire Compliant	No
Material - Resin	Nylon
Number of Rows	1
Packaging Type	Bag
Panel Mount	No
Pitch - Mating Interface (in)	0.098 In
Pitch - Mating Interface (mm)	2.50 mm
Stackable	No
Temperature Range - Operating	-40°C to +105°C

**Material Info**

**Reference - Drawing Numbers**

Product Specification	PS-51191-002, PS-51191-003, RPS-51191-007
Sales Drawing	SD-51191-004

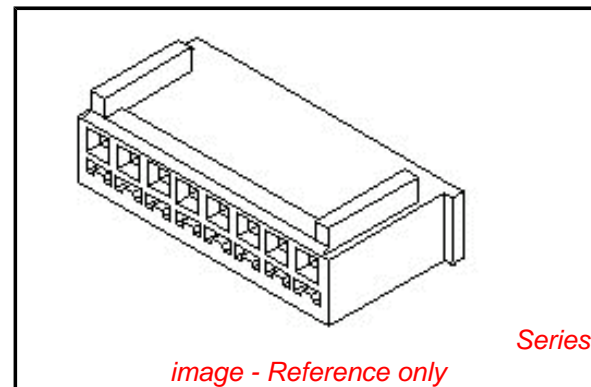

**EU RoHS**

**ELV and RoHS Compliant**  
**REACH SVHC Contains SVHC: No**  
**Halogen-Free Status**

**China RoHS**



**Need more information on product environmental compliance?**

Email [productcompliance@molex.com](mailto:productcompliance@molex.com)  
 For a multiple part number RoHS Certificate of Compliance, [click here](#)

Please visit the [Contact Us](#) section for any non-product compliance questions.

**Search Parts in this Series**

[51191Series](#)

**Mates With**

[5045](#) Vertical Header . [5046](#) Right Angle Header . [5240](#) Plug Housing

**Use With**

[50802](#) Crimp Terminal

10 9 8 7 6 5 4 3 2 1

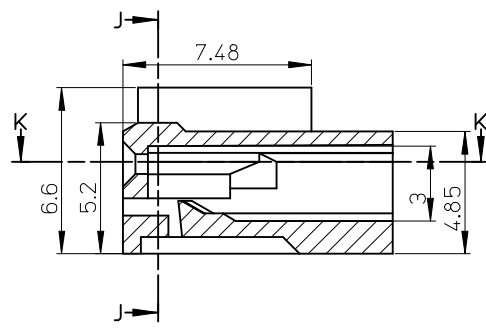
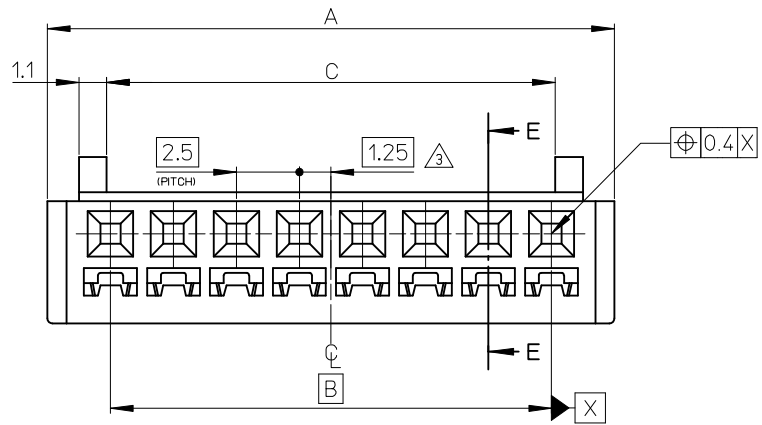

断面 E-E  
SECTION E-E

NOTES: 1. 適合ターミナル : 50802-\*\*\*\*  
 APPLICABLE TERMINAL : 50802-\*\*\*\*  
 2. 嵌合相手 : 5045,5046,5240シリーズ  
 MATE WITH : 5045,5046,5240 SERIES  
 △ 偶数極の製品に適用  
 APPLY EVEN CIRCUITS PRODUCTS

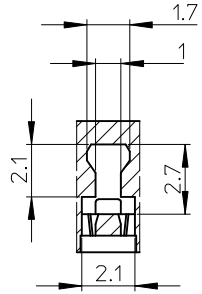
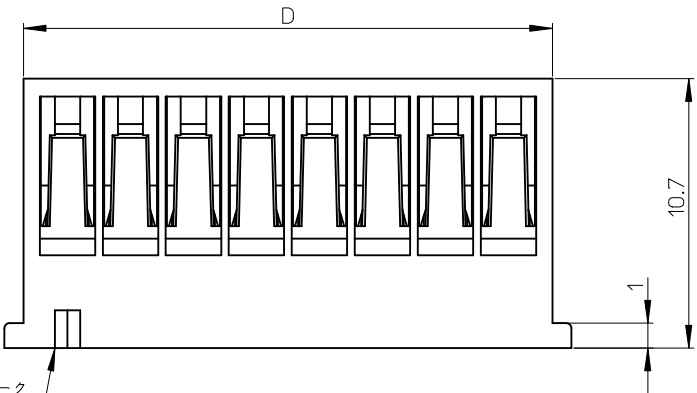

断面 J-J  
SECTION J-J

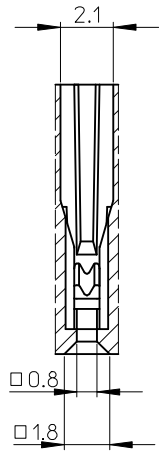

断面 K-K  
SECTION K-K

回路番号1マーク  
CKT.NO.1MARK

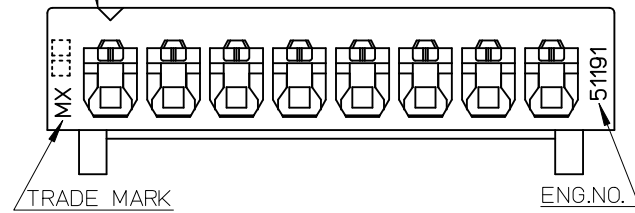

41	37.8	37.5	42.5	51191-1600	16
38.5	35.3	35	40	51191-1500	15
36	32.8	32.5	37.5	51191-1400	14
33.5	30.3	30	35	51191-1300	13
31	27.8	27.5	32.5	51191-1200	12
28.5	25.3	25	30	51191-1100	11
26	22.8	22.5	27.5	51191-1000	10
23.5	20.3	20	25	51191-0900	9
21	17.8	17.5	22.5	51191-0800	8
18.5	15.3	15	20	51191-0700	7
16	12.8	12.5	17.5	51191-0600	6
13.5	10.3	10	15	51191-0500	5
11	7.8	7.5	12.5	51191-0400	4
8.5	5.3	5	10	51191-0300	3
6	2.8	2.5	7.5	51191-0200	2
D	C	B	A	MATERIAL NO.	CKT.

材料 MATERIAL	NYLON66.JL94V-0
仕上げ FINISH	—#—
適用電線範囲 WIRE RANGE	—#—
被覆外径 INS. RANGE	—#—

REVISED EC NO. : J2009-1227 DRWN:YOSHIDAM 2008/12/19 CHKD:THARUYAMA 2008/12/19 APPR:NUKITA 2009/01/16	GENERAL TOLERANCES (UNLESS SPECIFIED)	DIMENSION STYLE MM ONLY
	10 UNDER ±0.2	DRAWN BY DATE S.MATSUZAKI 1998/04/09
	10 OVER 30 UNDER ±0.25	CHECKED BY DATE S.KUNISHI 1998/04/10
	30 OVER ±0.3	APPROVED BY DATE M.FUKUSHIMA 1998/04/10
ANGULAR ±---°	MATERIAL NO.	TITLE 2.5 WIRE TO BOARD CONN. HOUSING
DRAFT WHERE APPLICABLE MUST REMAIN WITHIN DIMENSIONS	SEE TABLE	SCALE DESIGN UNITS 5:1 METRIC
	SIZE A3	THIRD ANGLE PROJECTION

51191-***00	MODEL NO.
MOLEX INCORPORATED	DOCUMENT NO. SD-51191-004
THIS DRAWING CONTAINS INFORMATION THAT IS PROPRIETARY TO MOLEX INCORPORATED AND SHOULD NOT BE USED WITHOUT WRITTEN PERMISSION	
SHEET NO. 1 OF 1	