



# 4-Channel EMI Filter Array with ESD Protection

## CM1443-04CP

### Features

- Four channels of EMI filtering for data ports
- Pi-style EMI filters in a capacitor-resistor-capacitor (C-R-C) network
- $\pm 15\text{kV}$  ESD protection on each channel (IEC 61000-4-2 Level 4, contact discharge)
- $\pm 30\text{kV}$  ESD protection on each channel (HBM)
- Chip Scale Package (CSP) features extremely low lead inductance for optimum filter and ESD performance
- 10-bump; 0.4mm pitch, 1.560 x 1.053mm footprint
- *OptiGuard™* coating for improved reliability at assembly

### Applications

- EMI filtering and ESD protection for both data and I/O ports
- Wireless Handsets
- Handheld PCs / PDAs
- MP3 Players
- Notebooks
- Desktop PCs

### Electrical Schematic

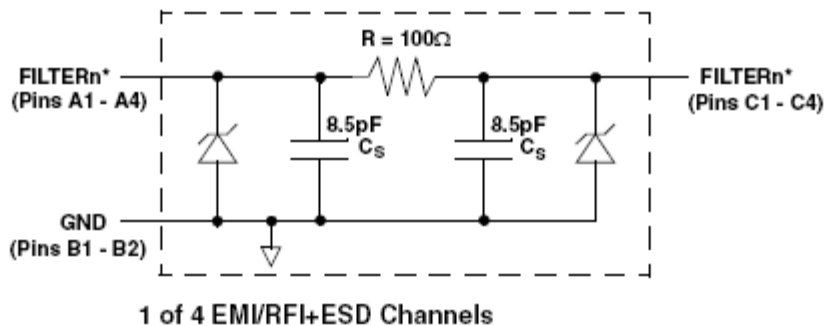

\* See Package/Pinout Diagram for expanded pin information.

**PACKAGE / PINOUT DIAGRAMS**

**TOP VIEW**  
(Bumps Down View)

**BOTTOM VIEW**  
(Bumps Up View)

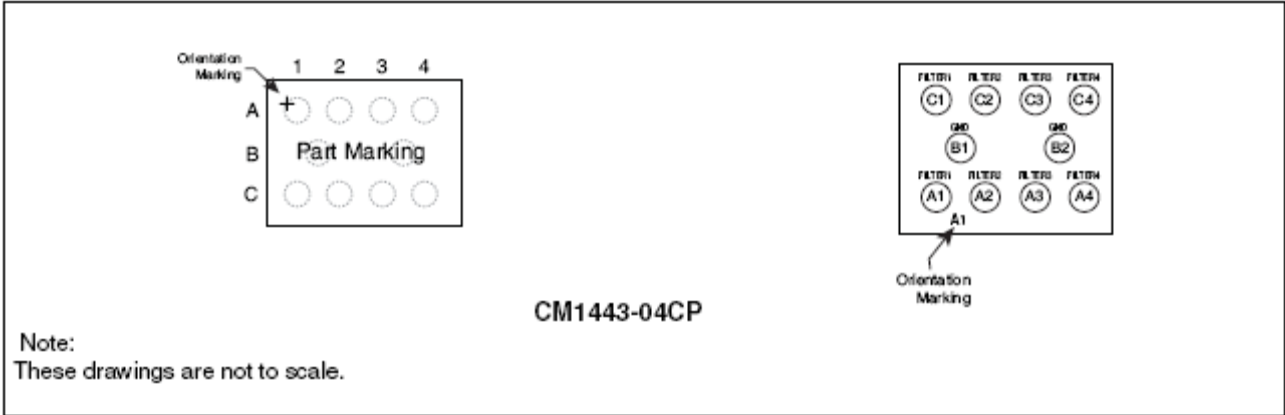

**PIN DESCRIPTIONS**

PIN(s)	NAME	DESCRIPTION
<b>-04</b>		
A1	FILTER1	Filter Channel 1
A2	FILTER2	Filter Channel 2
A3	FILTER3	Filter Channel 3
A4	FILTER4	Filter Channel 4
B1-B2	GND	Device Ground
C1	FILTER1	Filter Channel 1
C2	FILTER2	Filter Channel 2
C3	FILTER3	Filter Channel 3
C4	FILTER4	Filter Channel 4

CM1443-04CP

## Ordering Information

PART NUMBERING INFORMATION			
Bumps	Package	Lead-free Finish	
		Ordering Part Number <sup>1</sup>	Part Marking
10	CSP	CM1443-04CP	43

Note 1: Parts are shipped in Tape & Reel form unless otherwise specified.

## Specifications

ABSOLUTE MAXIMUM RATINGS		
PARAMETER	RATING	UNITS
Storage Temperature Range	-65 to +150	°C
DC Power per Resistor	100	mW
DC Package Power Rating	600	mW

STANDARD OPERATING CONDITIONS		
PARAMETER	RATING	UNITS
Operating Temperature Range	-40 to +85	°C

**ELECTRICAL OPERATING CHARACTERISTICS** (NOTE 1)

SYMBOL	PARAMETER	CONDITIONS	MIN	TYP	MAX	UNITS
R	Resistance		80	100	120	$\Omega$
$C_T$	Total Capacitance	At 2.5V DC	14	17	21	pF
$C_S$	Single Capacitor	At 2.5V DC		8.5		pF
$V_{DIODE}$	Diode Voltage (reverse bias)	$I_{DIODE}=10\mu A$	5.5			V
$I_{LEAK}$	Diode Leakage Current (reverse bias)	$V_{DIODE}=3.3V$		0.1	1.0	$\mu A$
$V_{SIG}$	Signal Voltage Positive Clamp Negative Clamp	$I_{LOAD} = 10mA$	5.6 -0.4	6.8 -0.8	9.0 -1.5	V V
$V_{ESD}$	In-system ESD Withstand Voltage a) Human Body Model, MIL-STD-883, Method 3015 b) Contact Discharge per IEC 61000-4-2 Level 4	Notes 2 and 4	$\pm 30$ $\pm 15$			kV kV
$V_{CL}$	Clamping Voltage during ESD Discharge MIL-STD-883 (Method 3015), 8kV Positive Transients Negative Transients	Notes 2,3 and 4		+10 -5		V V
$f_C$	Cut-off frequency $Z_{SOURCE} = 50\Omega$ , $Z_{LOAD} = 50\Omega$	$R = 100\Omega$ , $C_S = 8.5pF$		220		MHz

Note 1:  $T_A=25^\circ C$  unless otherwise specified.

Note 2: ESD applied to input and output pins with respect to GND, one at a time.

Note 3: Clamping voltage is measured at the opposite side of the EMI filter to the ESD pin. For example, if ESD is applied to Pin A1, then clamping voltage is measured at Pin C1.

Note 4: Unused pins are left open.

## Performance Information

Typical Filter Performance ( $T_A=25^\circ\text{C}$ , DC Bias=0V, 50 Ohm Environment)

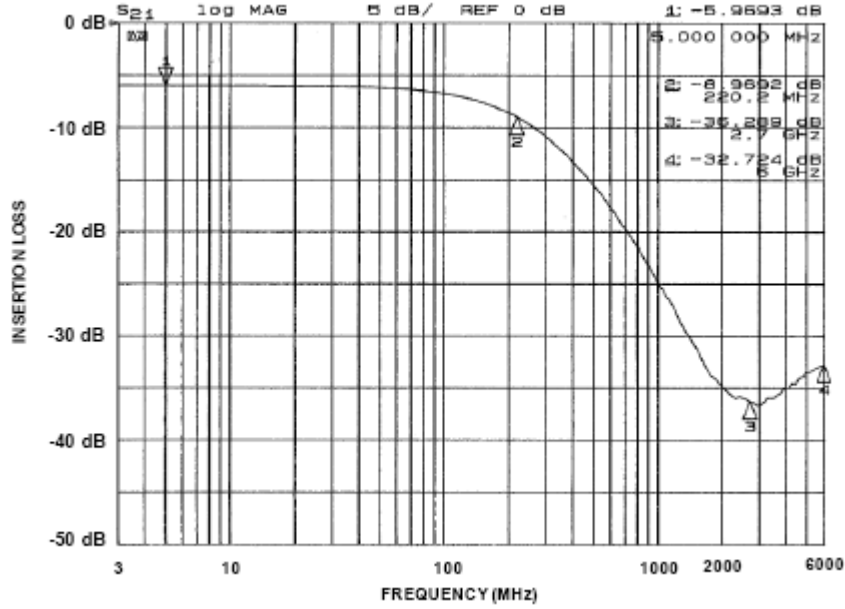

Figure 1. Insertion Loss VS. Frequency (A1-C1 to GND B1)

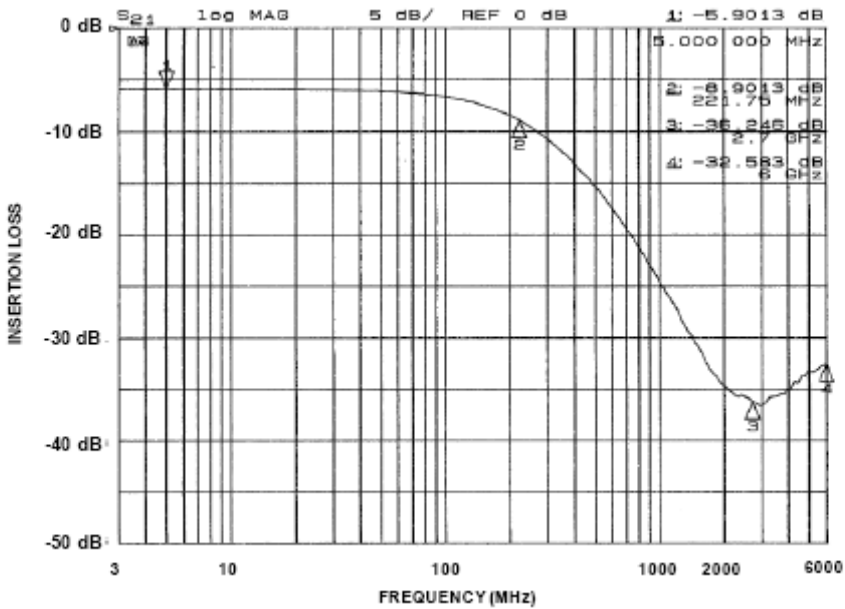

Figure 2. Insertion Loss VS. Frequency (A2-C2 to GND B1)

### Performance Information (cont'd)

Typical Filter Performance ( $T_A=25^\circ\text{C}$ , DC Bias=0V, 50 Ohm Environment)

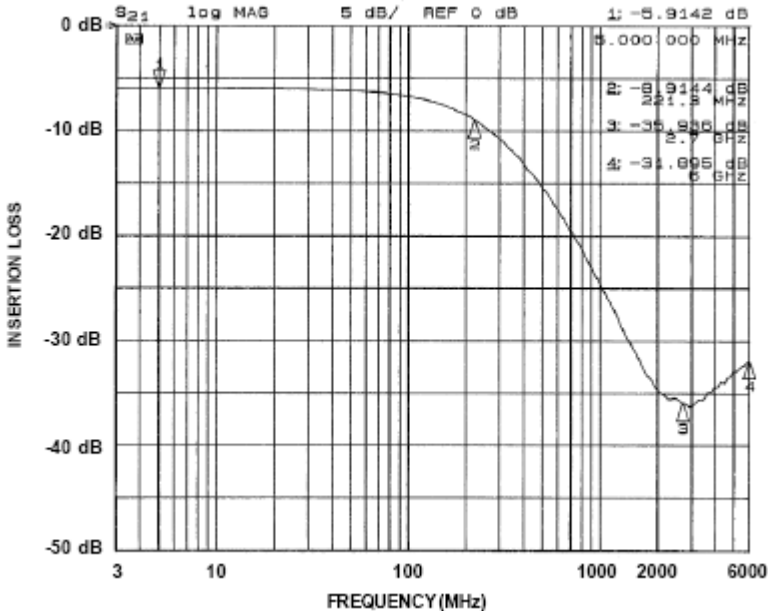

Figure 3. Insertion Loss VS. Frequency (A3-C3 to GND B2)

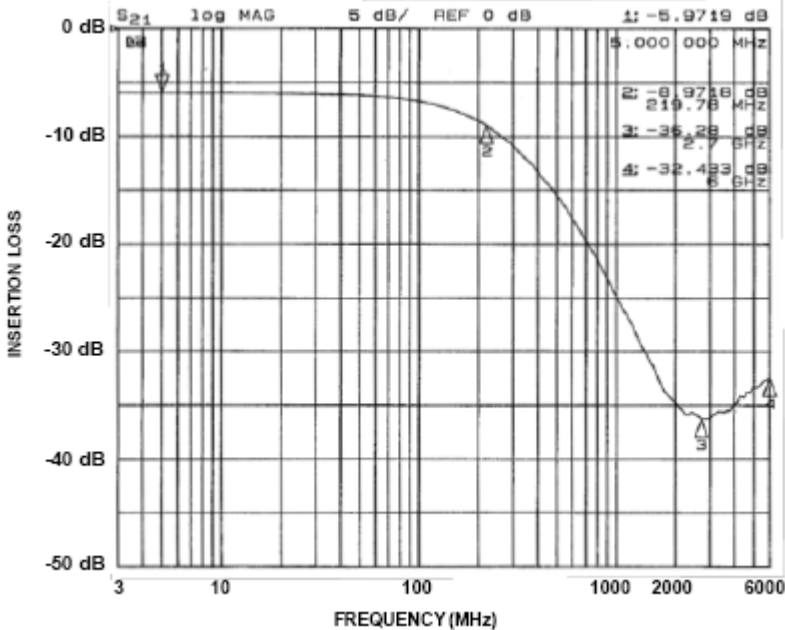

Figure 4. Insertion Loss VS. Frequency (A4-C4 to GND B2)

Performance Information (cont'd)

Typical Filter Performance ( $T_A=25^\circ\text{C}$ , DC Bias=0V, 50 Ohm Environment)

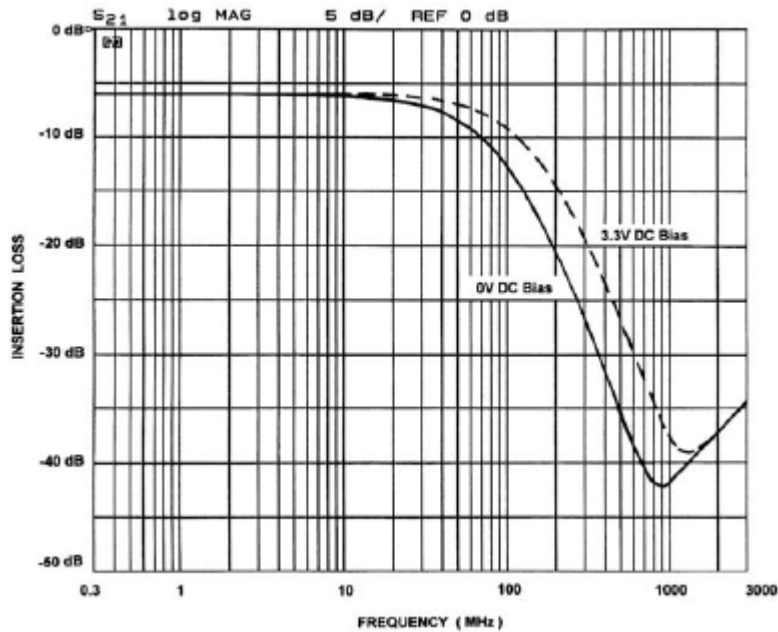

Figure 5. Comparison of Filter Response Curves for CM1443 VS. DC Bias

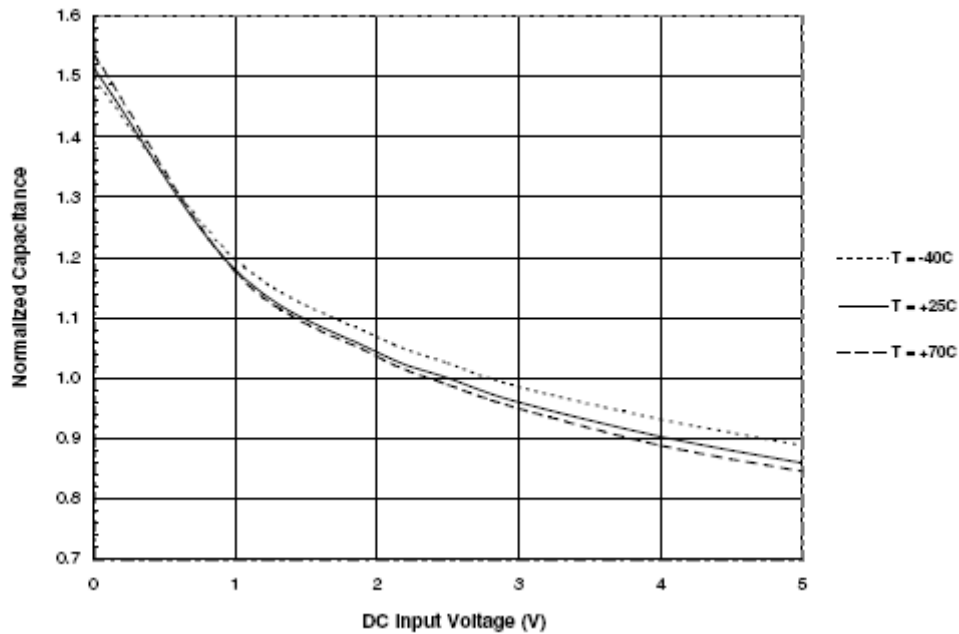
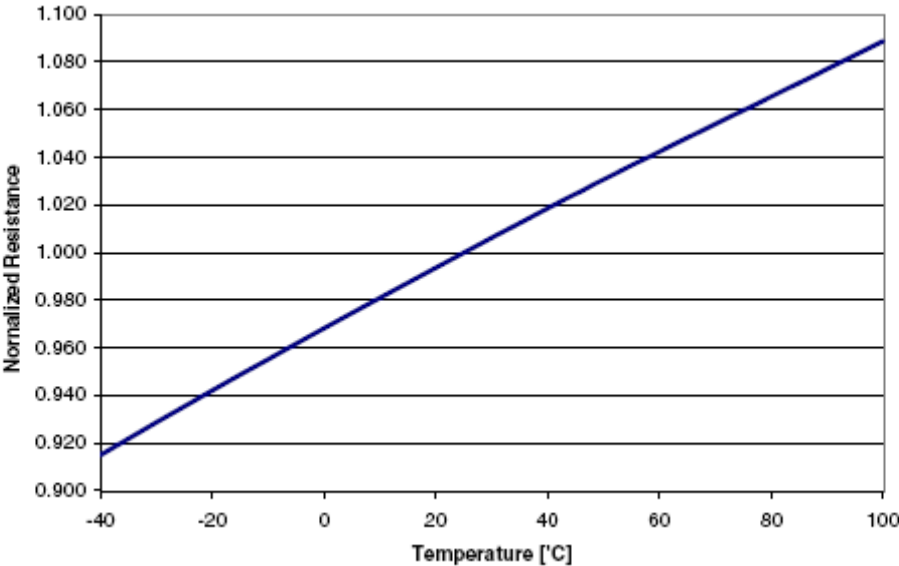

Figure 6. Filter Capacitance vs. Input Voltage over Temperature (normalized to capacitance at 2.5VDC and 25°C)

**Performance Information (cont'd)**



**Figure 7. Resistance vs. Temperature (normalized to resistance at 25°C)**

**Application Information**

Refer to Application Note AP-217, "The Chip Scale Package", for a detailed description of Chip Scale Packages offered by California Micro Devices.



# CM1443-04CP

## Mechanical Details

### 4-Channel CSP Mechanical Specifications

The CM1443-04CP-04CP is offered in a custom Chip Scale Package (CSP). Dimensions are presented below.

PACKAGE DIMENSIONS						
Package	Custom CSP					
Bumps	10					
Dim	Millimeters			Inches		
	Min	Nom	Max	Min	Nom	Max
A1	1.515	1.560	1.605	0.0596	0.0614	0.0632
A2	1.008	1.053	1.098	0.0397	0.0415	0.0432
B1	0.395	0.400	0.405	0.0156	0.0157	0.0159
B2	0.195	0.200	0.205	0.0077	0.0079	0.0081
B3	0.342	0.347	0.352	0.0135	0.0137	0.0139
B4	0.342	0.347	0.352	0.0135	0.0137	0.0139
C1	0.130	0.180	0.230	0.0051	0.0071	0.0091
C2	0.130	0.180	0.230	0.0051	0.0071	0.0090
D1	0.545	0.615	0.685	0.0215	0.0242	0.0270
D2	0.378	0.419	0.460	0.0149	0.0165	0.0181
# per tape and reel	3500 pieces					
Controlling dimension: millimeters						

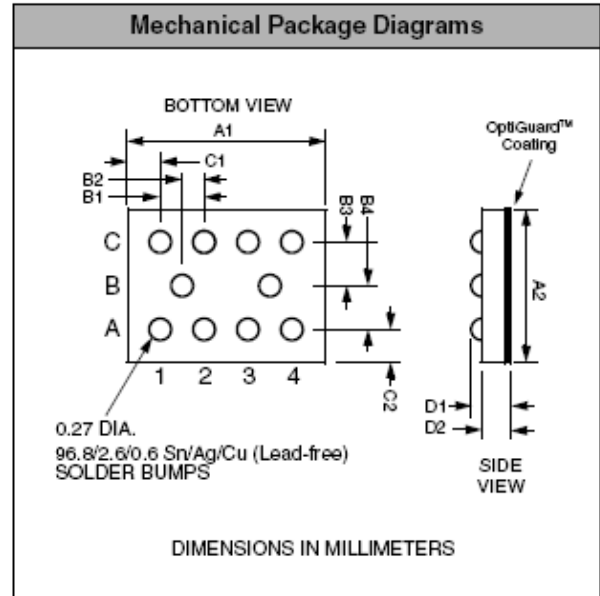

**Package Dimensions for  
4-Channel CM1443-04CP Chip Scale Package**

CSP Tape and Reel Specifications

PART NUMBER	CHIP SIZE (mm)	POCKET SIZE (mm) $B_0 \times A_0 \times K_0$	TAPE WIDTH W	REEL DIAMETER	QTY PER REEL	$P_0$	$P_1$
CM1443-04CP-04CP	1.56 X 1.053 X 0.615	1.67 X 1.17 X 0.73	8mm	178mm (7")	3500	4mm	4mm

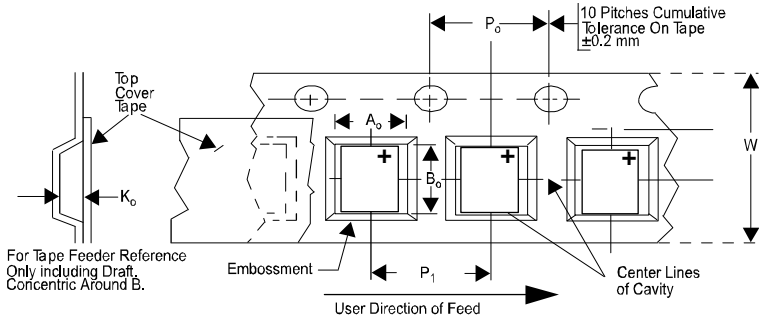



Figure 8. Tape and Reel Mechanical Data

ON Semiconductor and  are registered trademarks of Semiconductor Components Industries, LLC (SCILLC). SCILLC reserves the right to make changes without further notice to any products herein. SCILLC makes no warranty, representation or guarantee regarding the suitability of its products for any particular purpose, nor does SCILLC assume any liability arising out of the application or use of any product or circuit, and specifically disclaims any and all liability, including without limitation special, consequential or incidental damages. "Typical" parameters which may be provided in SCILLC data sheets and/or specifications can and do vary in different applications and actual performance may vary over time. All operating parameters, including "Typicals" must be validated for each customer application by customer's technical experts. SCILLC does not convey any license under its patent rights nor the rights of others. SCILLC products are not designed, intended, or authorized for use as components in systems intended for surgical implant into the body, or other applications intended to support or sustain life, or for any other application in which the failure of the SCILLC product could create a situation where personal injury or death may occur. Should Buyer purchase or use SCILLC products for any such unintended or unauthorized application, Buyer shall indemnify and hold SCILLC and its officers, employees, subsidiaries, affiliates, and distributors harmless against all claims, costs, damages, and expenses, and reasonable attorney fees arising out of, directly or indirectly, any claim of personal injury or death associated with such unintended or unauthorized use, even if such claim alleges that SCILLC was negligent regarding the design or manufacture of the part. SCILLC is an Equal Opportunity/Affirmative Action Employer. This literature is subject to all applicable copyright laws and is not for resale in any manner.

## PUBLICATION ORDERING INFORMATION

### LITERATURE FULFILLMENT:

Literature Distribution Center for ON Semiconductor  
P.O. Box 5163, Denver, Colorado 80217 USA  
**Phone:** 303-675-2175 or 800-344-3860 Toll Free USA/Canada  
**Fax:** 303-675-2176 or 800-344-3867 Toll Free USA/Canada  
**Email:** [orderlit@onsemi.com](mailto:orderlit@onsemi.com)

**N. American Technical Support:** 800-282-9855  
Toll Free USA/Canada  
**Europe, Middle East and Africa Technical Support:**  
Phone: 421 33 790 2910  
**Japan Customer Focus Center**  
Phone: 81-3-5773-3850

ON Semiconductor Website: [www.onsemi.com](http://www.onsemi.com)

Order Literature: <http://www.onsemi.com/orderlit>

For additional information, please contact your local Sales Representative