

16-Bit Stereo Audio DAC & Mono 1.8W Power Amplifier Plus Stereo Headphone Function

FEATURES

- Operation range: 2.7V~5.5V
- 16-bit resolution audio DAC
- Output mode : Speaker(BTL)/Headphone(SE)
- Output power, THD+N=1%
- Component less
- No zero crossing distortion
- Fast setting time permits 2*, 4*, and 8* oversampling (serial input) or double speed operation at 4* oversampling
- Audio format : I²S, Right justified ◦
- The minimum HIGH voltage of digital clocks(WS,DATA and BCK)and the control inputs can be 1.6V at V_{DD} = 5V.
- Excellent Power Supply Rejection Ratio(PSRR)
- Low power consumption
- Shutdown function
- Output voltages can be adjusted by the external resistors
- Housed in 24 pin SSOP(150mil), QFN(4x4x0.8)packages

Mode	R _L	5V	3.3V	2.7V
BTL	4Ω	1.8W	0.72W	450mW
	8Ω	1.2W	0.52W	330mW
SE	8Ω	0.3W	125mW	85mW
	32Ω	90mW	43mW	25mW

APPLICATIONS

- Multimedia system, Portable Digital Audio.

DESCRIPTION

The MS6337 is a 16-bits voltage-output Digital-to-Analog Converter (DAC) integrated class AB stereo headphone driver and mono speaker power amplifier. It can drive 1.8W of continuous average power into a mono 4Ω bridged-tied (BTL) speaker or 2 * 90mW into stereo 32Ω single ended (SE) headphone. The 16-bit DAC supports popular formats as I2S, Right Justified.

The MS6337 is with the excellent Power Supply Rejection Ratio(PSRR) and features extremely low power dissipation, small package size and easy application. The accuracy of the matched coarse current sources, combined with the unique symmetrical decoding method, preclude zero-crossing distortion and ensures high quality audio reproduction. These unique features, combined with its exceptional performance, make the MS6337 ideally suited for use in digital audio equipment.

BLOCK DIAGRAM

Shutdown control		
SD_Mode	SD	Status
0	0	SD
0	1	On
1	0	On
1	1	SD

Format control	
FORMAT	Status
0	I2S
1	RJF

DAC control	
DAC_SD	Status
0	SD
1	Active

CAP control	
CAP_DC	Status
0	Discharge
1	Charge

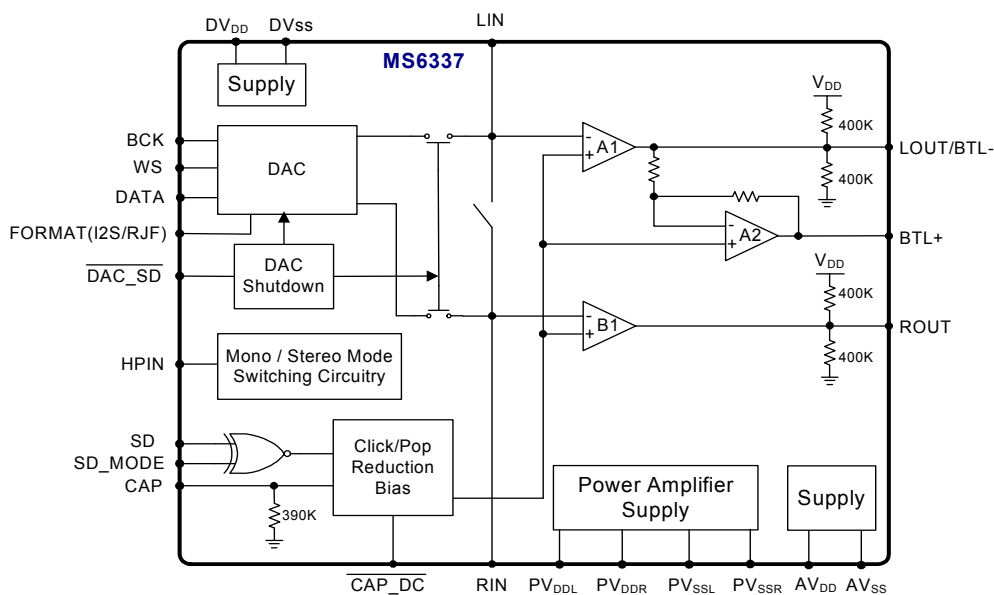

PIN CONFIGURATION

SSOP24

Symbol	Pin	Description
PV _{DDL}	1	Positive supply voltage for left channel of power amplifier
LOUT/BTL-	2	SE left channel output or negative output of BTL
AV _{SS}	3	Negative supply voltage
PV _{SSL}	4	Negative supply voltage for left channel of power amplifier
LIN	5	Left channel input
SD_MODE	6	The shutdown mode selects the shutdown logic level of the SD pin.
SD	7	SD_MODE = 0, the device is shutdown when SD is logic low. SD_MODE = 1, the device is shutdown when SD is logic high.
AV _{SS}	8	Negative supply voltage
DV _{SS}	9	Digital Ground
/DAC_SD	10	DAC shutdown pin. /DAC_SD=0, DAC is shutdown. /DAC_SD=1, DAC is Active.
DATA	11	Audio data input
WS	12	Audio word select input
BCK	13	Audio bit clock input
FORMAT	14	Audio format. FORMAT=0, I2S format. FORMAT=1, Right justified format.
DV _{DD}	15	Digital Positive supply voltage
AV _{DD}	16	Analog Positive supply voltage
/CAP_DC	17	CAP discharge. This pin is functional only as the system is shutdown.
HPIN	18	Headphone input detection.(refer to Page.14 for detection levels) A logical low sets BTL mode, a logical high sets SE mode.
CAP	19	Capacitor connected
RIN	20	Right channel input
PV _{SSR}	21	Negative supply voltage for right channel of power amplifier
ROUT	22	SE right channel output
PV _{DDR}	23	Positive supply voltage for right channel of power amplifier
BTL+	24	Positive output of BTL

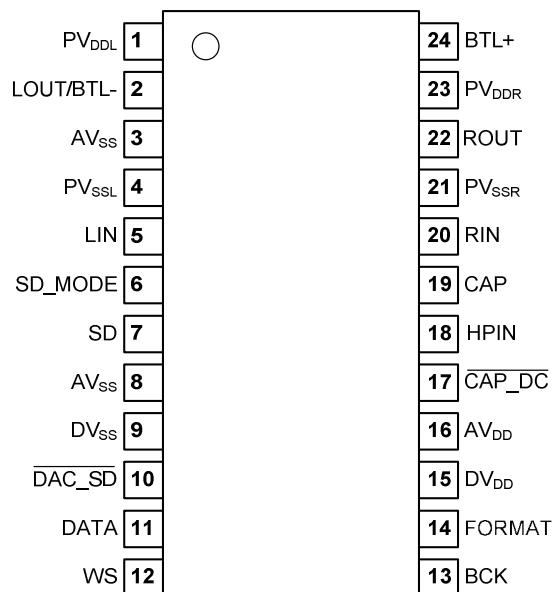

QFN20

Symbol	Pin	Description
AV _{DD}	1	Analog Positive supply voltage
/CAP_DC	2	CAP discharge. This pin is functional only as the system is shutdown.
HPIN	3	Headphone input detection.(refer to Page.14 for detection levels) A logical low sets BTL mode, a logical high sets SE mode.
CAP	4	Capacitor connected
RIN	5	Right channel input
PV _{SSR}	6	Negative supply voltage for right channel of power amplifier
ROUT	7	SE right channel output
PV _{DDR}	8	Positive supply voltage for right channel of power amplifier
BTL+	9	Positive output of BTL
PV _{DDL}	10	Positive supply voltage for left channel of power amplifier
LOUT/BTL-	11	SE left channel output or negative output of BTL
AV _{SS}	12	Negative supply voltage
PV _{SSL}	13	Negative supply voltage for left channel of power amplifier
LIN	14	Left channel input
SD_MODE	15	The shutdown mode selects the shutdown logic level of the SD pin.
SD	16	SD_MODE = 0, the device is shutdown when SD is logic low. SD_MODE = 1, the device is shutdown when SD is logic high.
AV _{SS}	17	Negative supply voltage
DV _{SS}	18	Digital Ground
/DAC_SD	19	DAC shutdown pin. /DAC_SD=0, DAC is shutdown. /DAC_SD=1, DAC is Active.
DATA	20	Audio data input
WS	21	Audio word select input
BCK	22	Audio bit clock input
FORMAT	23	Audio format. FORMAT=0, I2S format. FORMAT=1,Right justified format.
DV _{DD}	24	Digital Positive supply voltage

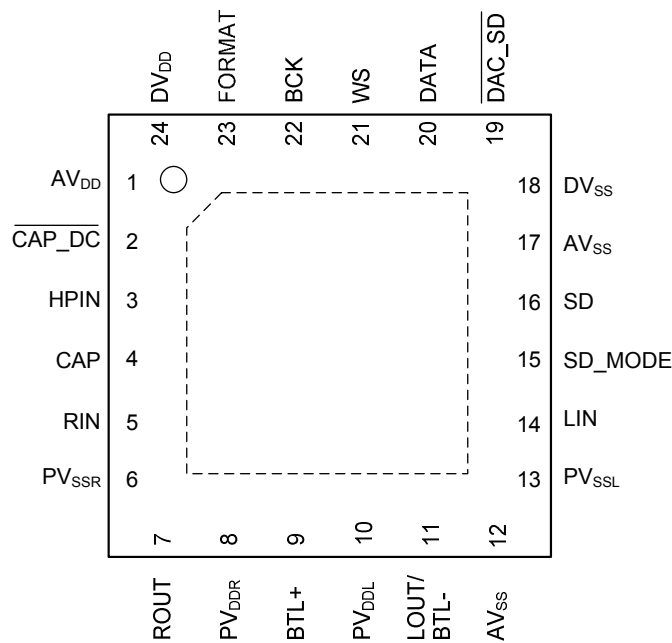

ORDERING INFORMATION

Package	Part number	Packaging Marking	Transport Media
24-Pin SSOP (lead free)	MS6337GTR	MS6337G	2.5k Units Tape and Reel
24-Pin SSOP (lead free)	MS6337GU	MS6337G	56 Units Tube
24-Pin QFN (lead free)	MS6337QTR	6337	5k Units Tape and Reel

RoHS Compliance

ABSOLUTE MAXIMUM RATINGS

Symbol	Parameter	Rating	Unit
V _{DD}	Positive Supply Voltage	6	V
V _{ESD}	Electrostatic Handling	-2000 to 2000	V
T _{STG}	Storage Temperature Range	-40 to 125	°C
T _A	Operating Ambient Temperature Range	-40 to 85	°C
T _J	Maximum Junction Temperature	120	°C
T _S	Soldering Temperature, 10 seconds	260	°C
R _{THJA}	Thermal Resistance from Junction to Ambient in Free Air SSOP24 QFN24 (enhance thermal pad)	90 65	°C/W

OPERATING RATINGS

Symbol	Parameter	Min	Typ.	Max	Unit
V _{DD}	Supply Voltage	2.7	5	5.5	V

5V ELECTRICAL CHARACTERISTICS

($T_a=25^{\circ}\text{C}$, $V_{DD}=5\text{V}$, $V_{SS}=0\text{V}$, $f=1\text{kHz}$, $R_F=24\text{K}\Omega$ [refer to Fig. 4], $\text{BW}<30\text{kHz}$; Unless otherwise specified)

Symbol	Parameter	Conditions	Min	Typ.	Max	Unit
DC Characteristics						
V_{CAP}	Voltage at CAP		2.35	2.5	2.65	V
V_{FS}	Full scale output voltage	$V_{FS}=0.015775 * R_F * V_{DD}$	$V_{FS}-10\%$	V_{FS}	$V_{FS}+10\%$	V
I_Q	Quiescent current	Audio code 0000H, BTL	6	8	12	mA
		Audio code 0000H, SE	4.4	5.5	6.6	
I_{SD}	Shutdown current	All devices shutdown	11	17	25	μA
V_{HP}	Headphone hysteresis point	SE Mode	3.8	-	-	V
		BTL Mode	-	-	3.2	
AC Characteristics						
Res	Resolution		-	-	16	bits
PSRR	Power supply rejection ratio	BTL Mode, $R_L=8\Omega$ CAP=1 μF , $f=200\text{Hz}$		61		dB
		SE Mode, $R_L=32\Omega$ CAP=1 μF , $f=200\text{Hz}$		66		dB
CS	Channel separation	SE Mode, $R_L=32\Omega$, V_{FS}		90		dB
THD+N	Total harmonic distortion plus Noise	SE mode, $R_L=32\Omega$, V_{FS}		-64	-60	dB
				0.062	0.1	%
S/N	Signal-to-noise ratio	SE mode, A-weighting, V_{FS}	86	90		dB
Po	Output power	BTL Mode, $R_L = 4\Omega$ THD+N = 1%	-	1.8	-	W
		BTL Mode, $R_L = 8\Omega$ THD+N = 1%	-	1.2	-	W
		SE Mode, $R_L = 8\Omega$ THD+N = 1%	-	300m	-	W
		SE Mode, $R_L = 32\Omega$ THD+N = 1%	-	90m	-	W

3.3V ELECTRICAL CHARACTERISTICS

($T_a=25^{\circ}\text{C}$, $V_{DD}=3.3\text{V}$, $V_{SS}=0\text{V}$, $f=1\text{kHz}$, $R_F=24\text{K}\Omega$ [refer to Fig. 4] ; Unless otherwise specified)

Symbol	Parameter	Conditions	Min	Typ.	Max	Unit
DC Characteristics						
V_{CAP}	Voltage at CAP		1.55	1.65	1.75	V
V_{DC}	Output DC level		1.55	1.65	1.75	V
V_{FS}	Full scale output voltage	$V_{FS}=0.015775 * R_F * V_{DD}$	$V_{FS}-10\%$	V_{FS}	$V_{FS}+10\%$	V
I_Q	Quiescent current	Audio code 0000H, BTL	5.4	6.6	9.9	mA
		Audio code 0000H, SE	3.8	4.8	5.8	mA
I_{SD}	Shutdown current	All devices shutdown	7.3	11.2	16.5	uA
V_{HP}	Headphone hysteresis point	SE Mode	2.3	-	-	V
		BTL Mode	-	-	1.9	
AC Characteristics						
THD+N	Total harmonic distortion plus noise	SE mode, $R_L=32\Omega$, V_{FS}		-63	-58	dB
				0.07	0.126	%
Po	Output power	BTL Mode, $R_L = 4\Omega$ THD+N = 1%	-	0.72	-	W
		BTL Mode, $R_L = 8\Omega$ THD+N = 1%	-	0.52	-	W
		SE Mode, $R_L = 8\Omega$ THD+N = 1%	-	125m	-	W
		SE Mode, $R_L = 32\Omega$ THD+N = 1%	-	43m	-	W

2.7V ELECTRICAL CHARACTERISTICS

($T_a=25^{\circ}\text{C}$, $V_{DD}=2.7\text{V}$, $V_{SS}=0\text{V}$, $f=1\text{kHz}$, $R_F=24\text{K}\Omega$ [refer to Fig, 4]; Unless otherwise specified)

Symbol	Parameter	Conditions	Min	Typ.	Max	Unit
DC Characteristics						
V_{CAP}	Voltage at CAP		1.25	1.35	1.45	V
V_{DC}	Output DC level		1.25	1.35	1.45	V
V_{FS}	Full scale output voltage	$V_{FS}=0.015775 * R_F * V_{DD}$	$V_{FS}-10\%$	V_{FS}	$V_{FS}+10\%$	V
I_Q	Quiescent current	Audio code 0000H, BTL	4.5	6	9	mA
		Audio code 0000H, SE	3.6	4.5	5.4	mA
I_{SD}	Shutdown current	All devices shutdown	5.5	9.2	13.5	uA
V_{HP}	Headphone hysteresis point	SE Mode	1.8	-	-	V
		BTL Mode	-	-	1.5	
AC Characteristics						
THD+N	Total harmonic distortion plus noise	SE mode, $R_L=32\Omega$, V_{FS}		-63	-58	dB
				0.07	0.126	%
Po	Output power	BTL Mode, $R_L = 4\Omega$, THD+N = 1%	-	0.45	-	W
		BTL Mode; $R_L = 8\Omega$ THD+N = 1%	-	0.33	-	W
		SE Mode; $R_L = 8\Omega$ THD+N = 1%	-	85m	-	W
		SE Mode; $R_L = 32\Omega$ THD+N = 1%	-	25m	-	W

TYPICAL PERFORMANCE CHARACTERISTICS

($T_a=25^\circ\text{C}$, sampling rate=4fs, $f_s=44.1\text{kHz}$, $R_F=24\text{K}$; unless otherwise specified)

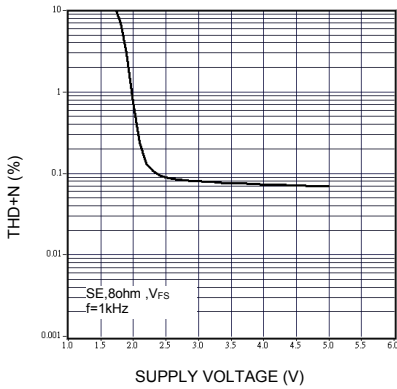

THD+N vs. supply voltage

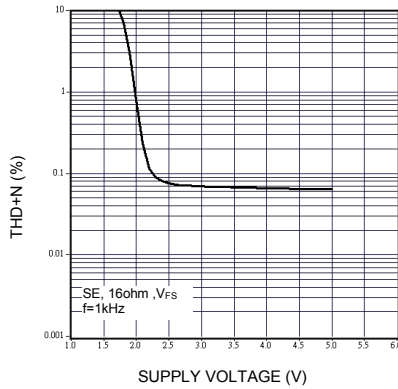

THD+N vs. supply voltage

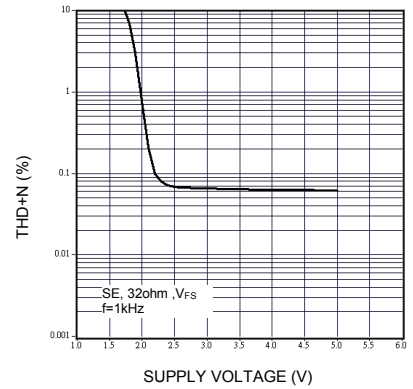

THD+N vs. supply voltage

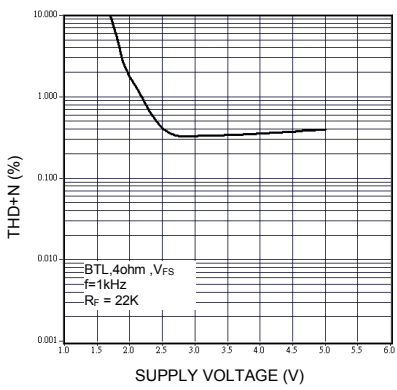

THD+N vs. supply voltage

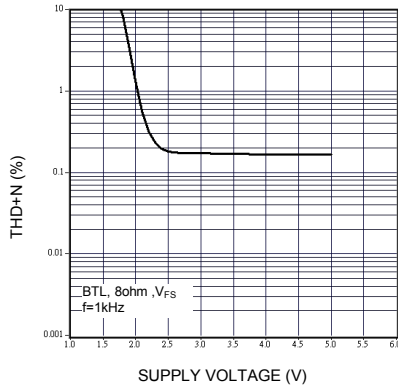

THD+N vs. supply voltage

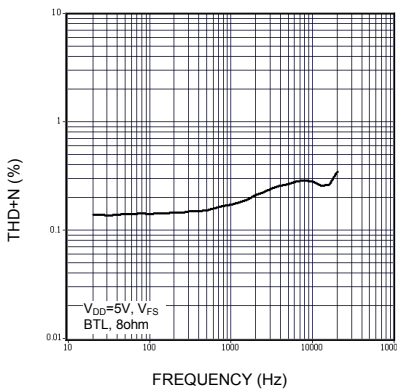

THD+N vs. frequency

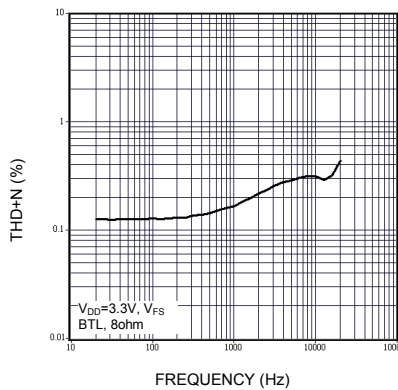

THD+N vs. frequency

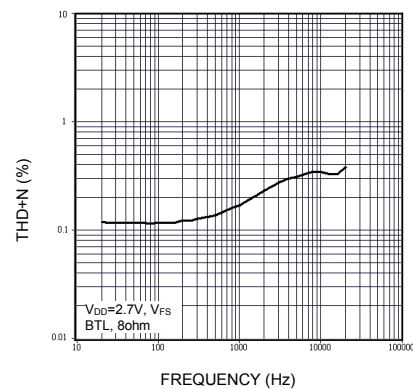

THD+N vs. frequency

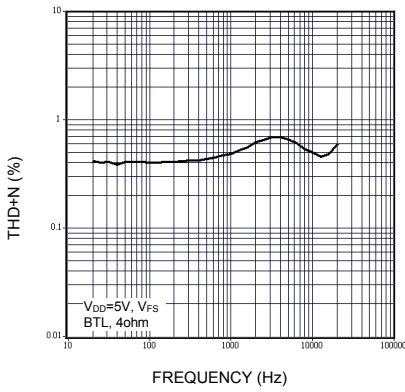

THD+N vs. frequency

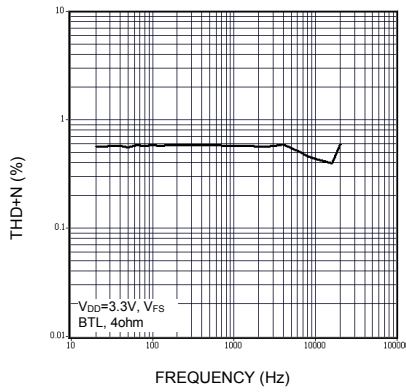

THD+N vs. frequency

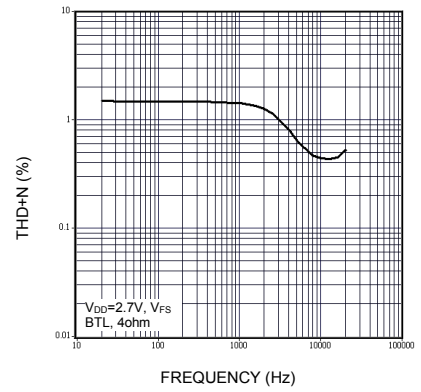

THD+N vs. frequency

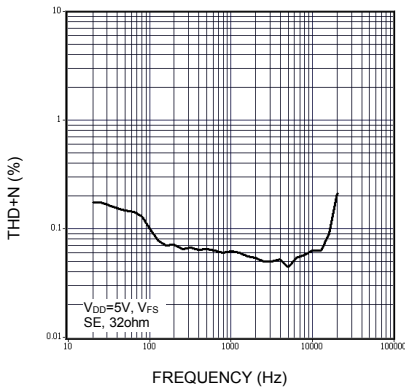

THD+N vs. frequency

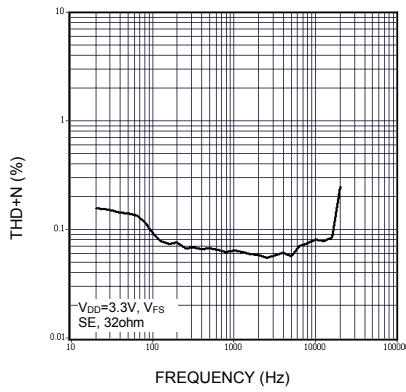

THD+N vs. frequency

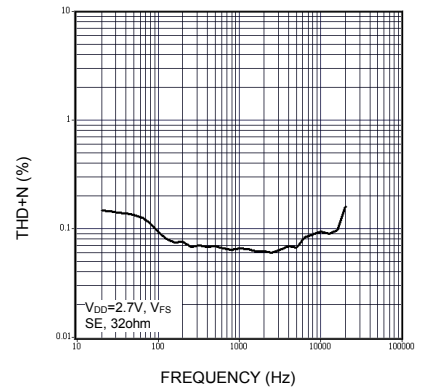

THD+N vs. frequency

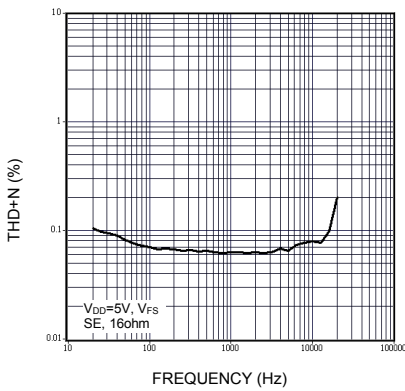

THD+N vs. frequency

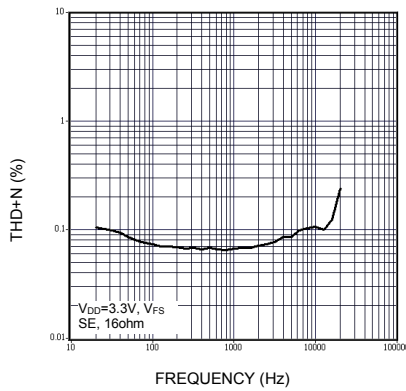

THD+N vs. frequency

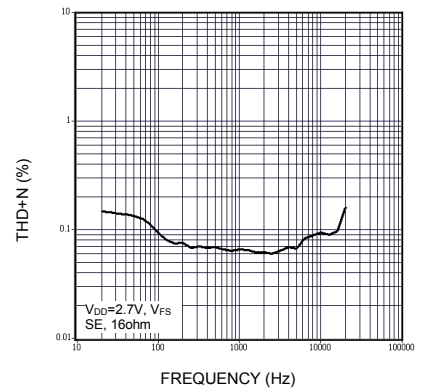

THD+N vs. frequency

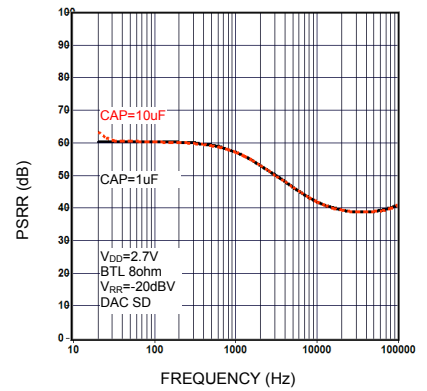
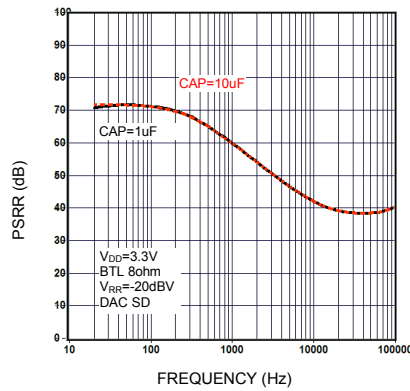
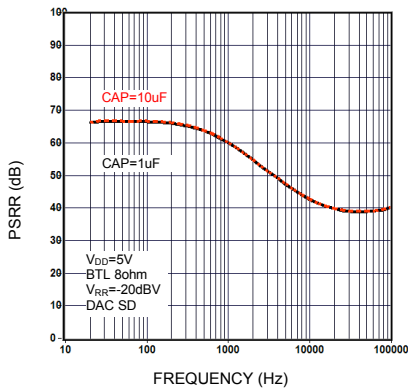
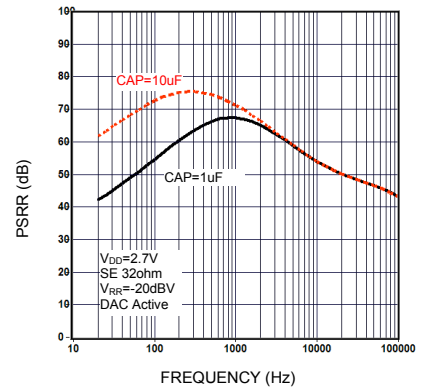
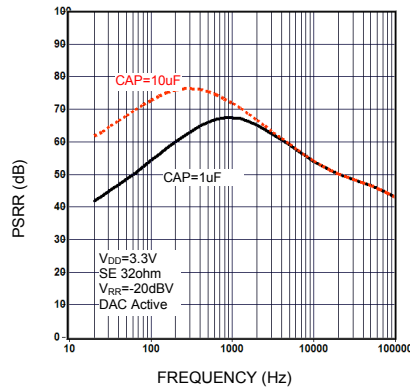
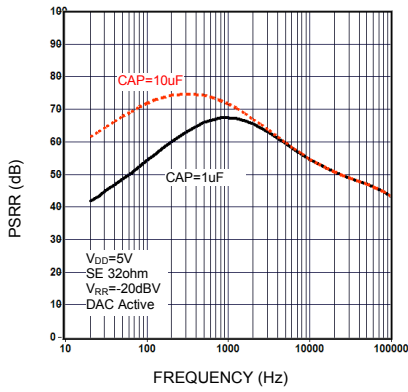
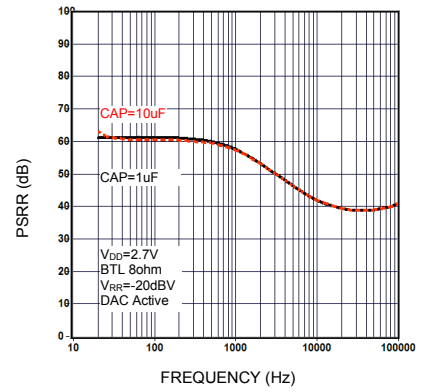
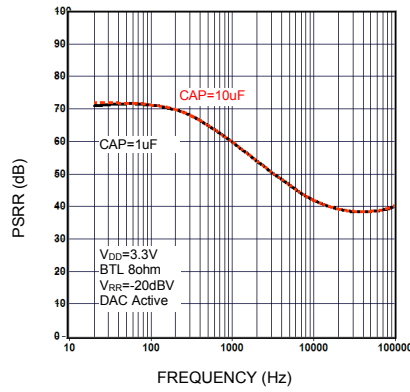
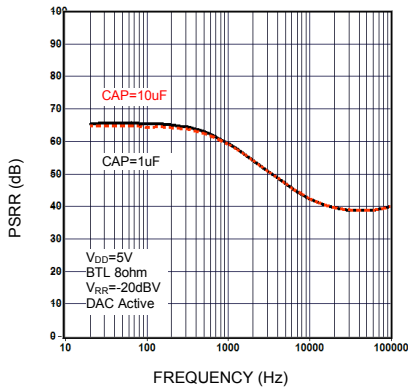

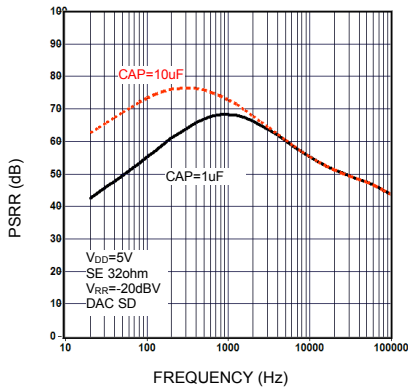

PSRR (5V) vs. frequency

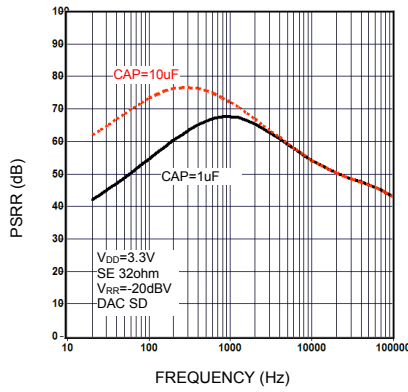

PSRR (3.3V) vs. frequency

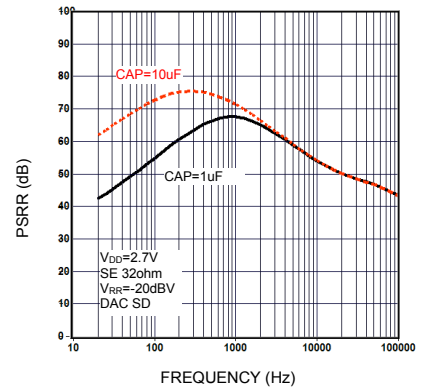

PSRR (2.7V) vs. frequency

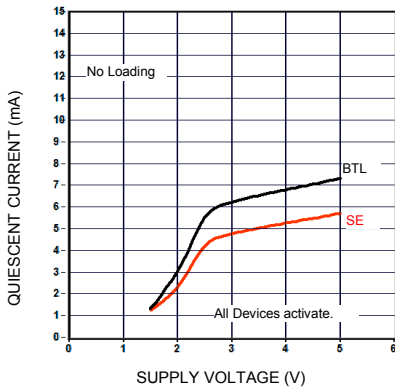

Quiescent current vs. supply voltage

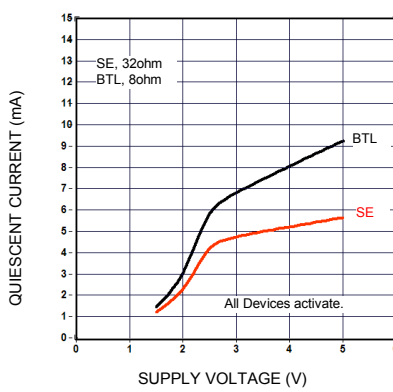

Quiescent current vs. supply voltage

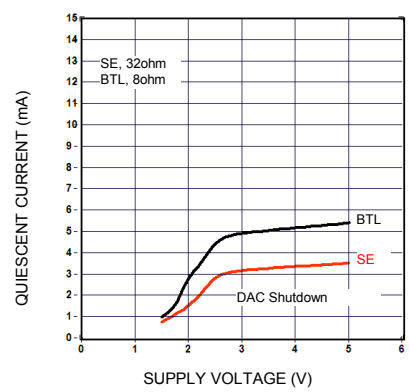

Quiescent current vs. supply voltage

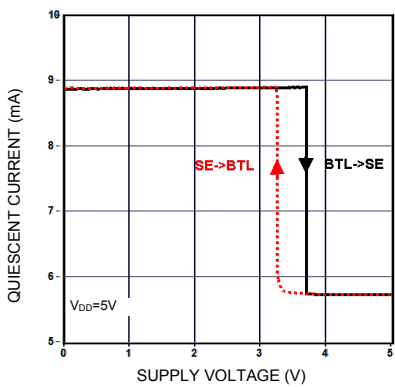

Mode vs. HP-IN voltage

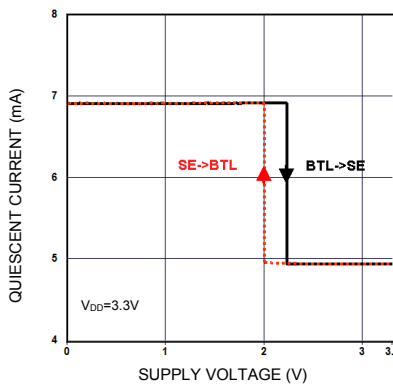

Mode vs. HP-IN voltage

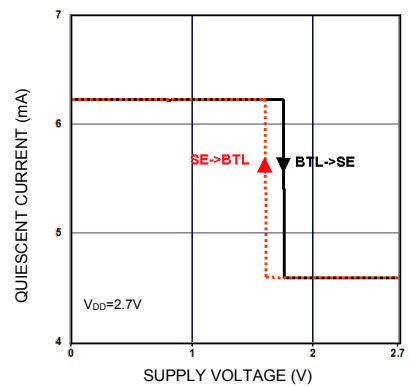

Mode vs. HP-IN voltage

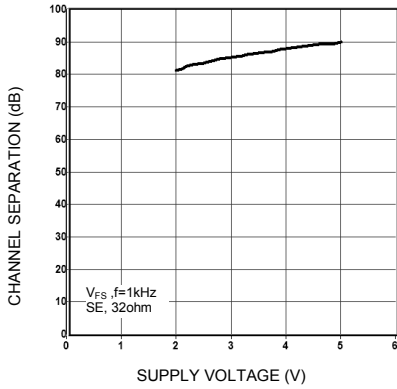

Channel separation vs. supply voltage

TIMING AND DATA FORMAT

The MS6337 accepts input serial data formats of 16-bit word length. Left and right data words are time multiplexed. The MSB must always be first.

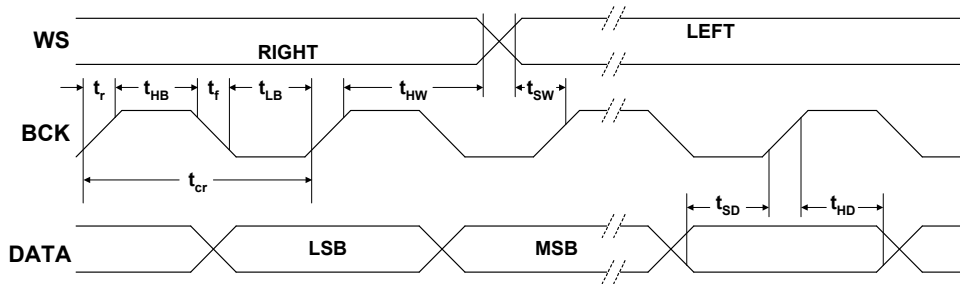

Fig.1 Timing and input signals.

Data format (BCK, WS and DATA)

Symbol	Parameter	Conditions	Min	Typ.	Max	Unit
V_{IL}	Input LOW level		-	-	0.7	V
V_{IH}	Input HIGH level		1.6	-	-	V
I_{IL}	Input Leakage Current LOW		-	-	10	μA
I_{IH}	Input Leakage Current HIGH		-	-	10	μA
f_{BCK}	Input Clock Frequency		-	-	18.4	MHz
BR	Bit Rate Data Input		-	-	18.4	Mbits/s
f_{ws}	Word Select Input		-	-	384	kHz
t_r	Rise Time		-	-	12	ns
t_f	Fall Time		-	-	12	ns
t_{cr}	Bit Clock Cycle Time		54	-	-	ns
t_{HB}	Bit Clock High Time		15	-	-	ns
t_{LB}	Bit Clock Low Time		15	-	-	ns
t_{SD}	Data Set-up Time		12	-	-	ns
t_{HD}	Data Hold Time to Bit Clock		2	-	-	ns
t_{HW}	Word Select Hold Time		2	-	-	ns
t_{sw}	Word Select Set-up Time		12	-	-	ns

Right justified format

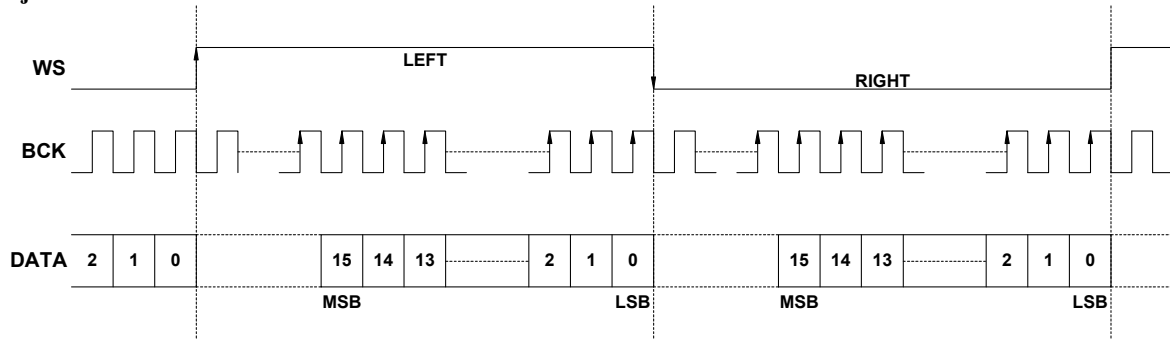

Fig.2 Right justified format

I2S format

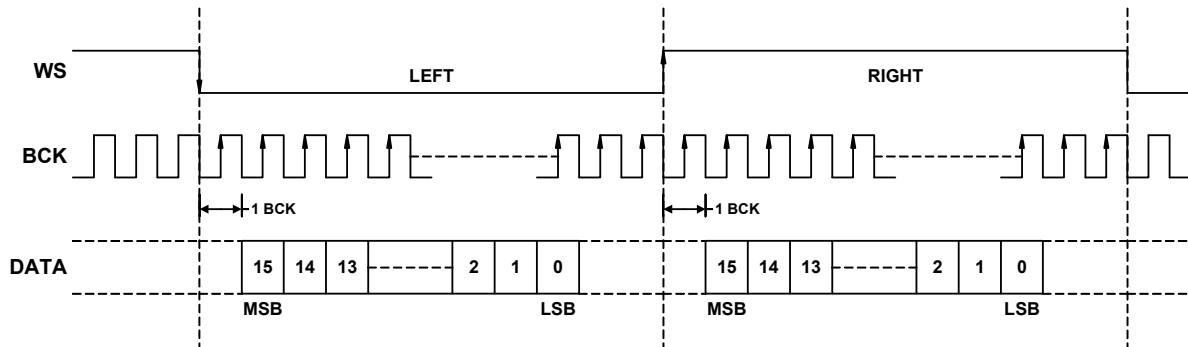
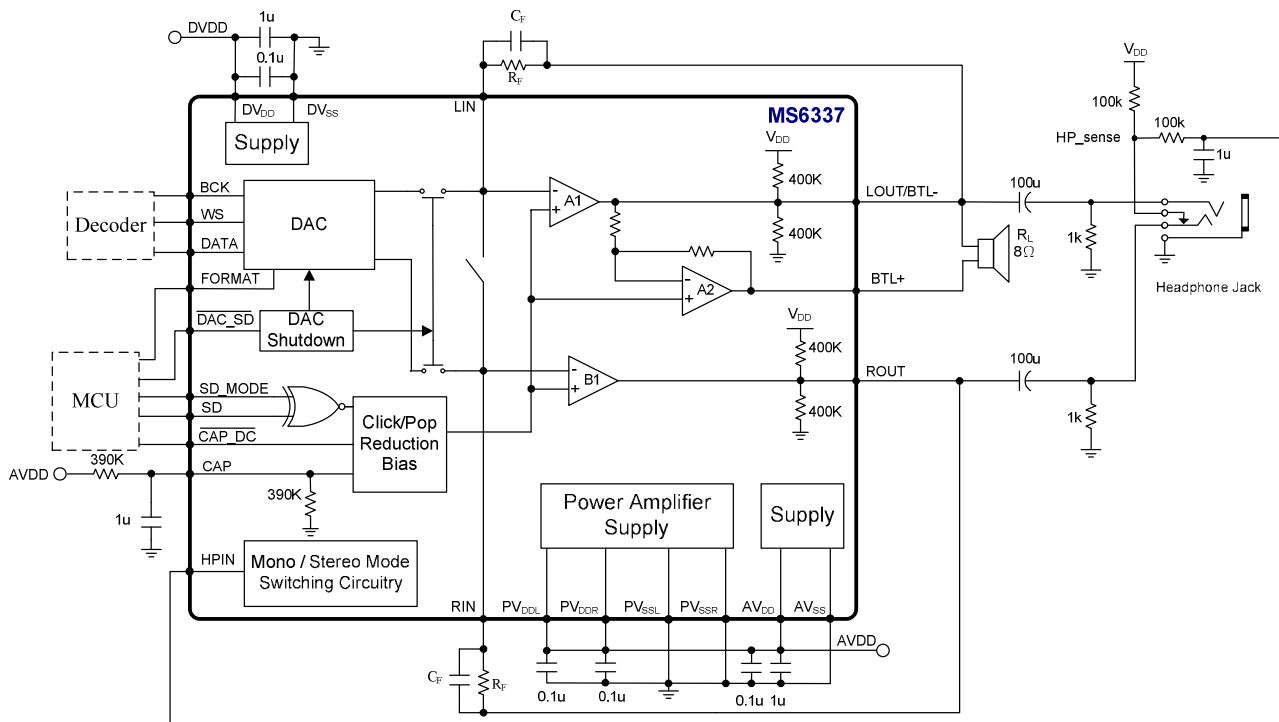

Fig.3 I2S format

APPLICATION INFORMATION

Basic application example



Note: $V_{DAC\ out} = 0.015775 * R_F * V_{DD}$ (Vpp)
 R_F / C_F to decide -3dB point
 For $V_{DD} = 3V$, $R_L = 32\Omega$, $R_F = 24k$, $C_F = 390pF$, $V_{DAC\ out} = 1.134Vpp$
 $R_L = 16\Omega$, $R_F = 22k$, $C_F = 470pF$, $V_{DAC\ out} = 1.04Vpp$

Fig.4 Basic application circuit.

SE mode and BTL mode operation

As shown in the block diagram (Page.1), for the SE mode, the MS6337 operates as a high drive dual operational amplifiers.

Amplifier A1 and B1 are independent amplifiers with an externally configured gain of $A_V = -R_F / R_{IN}$. Amplifier A2 is shutdown to a high output impedance state. That is, the mono speaker is muted.

For the BTL mode, the audio signal from the RIN pin is connected directly to the inverting input of A1. As a result, the L-IN and R-IN audio signals, either from DAC or Line in, are summed together at the input of A1. A2 is then activated with a closed-loop gain of $A_V = -1$ fixed by two internal resistors. The outputs of A1 and A2 are then used to drive the mono bridged-tied load.

Also in the BTL mode, the amplifier B1 functions as an unit gain buffer. The output voltage of B1 will follow V_{cap} , in which no current goes through the feedback resistor R_F of B1. This will insure that as HPIN goes low there is no transient of R_{out} for the BTL mode.

EXTERNAL DIMENSIONS

SSOP24

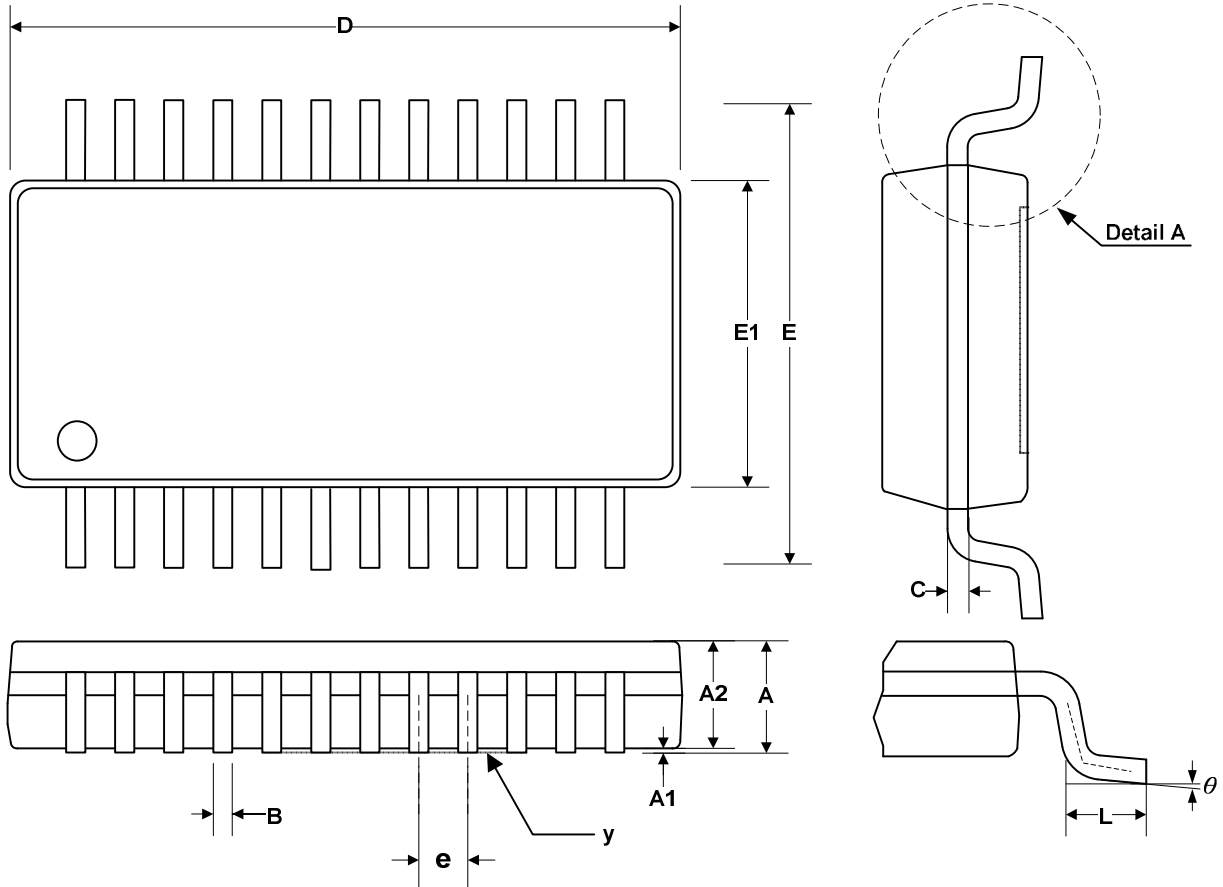

Symbol	Dimension in mm			Dimension in inches		
	Min	Nom	Max	Min	Nom	Max
A	1.35	1.6	1.75	0.053	0.064	0.069
A1	0.1	-	0.25	0.004	-	0.010
A2	-	1.45	-	-	0.057	-
B	0.2	0.25	0.30	0.008	0.010	0.012
C	0.19	-	0.25	0.007	-	0.010
D	8.55	-	8.75	0.337	-	0.344
E	5.8	6.0	6.2	0.228	0.236	0.244
E1	3.8	3.9	4.0	0.150	0.153	0.157
e	0.640 BASIC			0.025 BASIC		
L	0.40	-	1.27	0.016	-	0.05
θ	0°	-	8°	0°	-	8°
y	-	-	0.10	-	-	0.004

QFN24 (4x4mm)

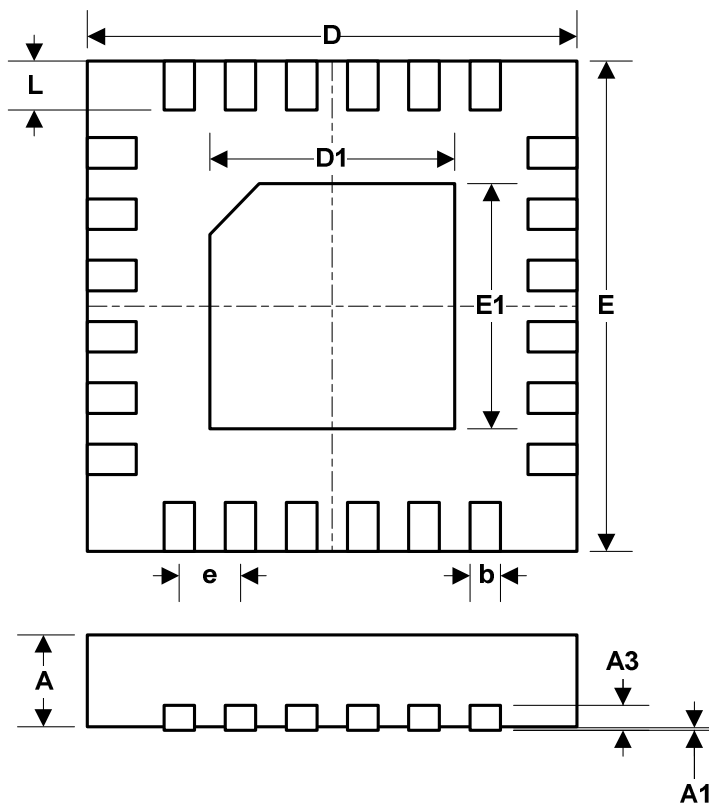

Symbol	Dimension in mm			Dimension in inch		
	Min	Nom	Max	Min	Nom	Max
A	0.70	0.75	0.80	0.02756	0.02953	0.03150
A1	0	0.02	0.05	0	0.00079	0.00197
A3	0.203REF			0.008REF		
b	0.18	0.25	0.30	0.00709	0.00984	0.01181
D	3.90	4.00	4.10	0.1535	0.1575	0.1614
D1	1.90	2.00	2.10	0.0748	0.0787	0.0827
E	3.90	4.00	4.10	0.1535	0.1575	0.1614
E1	1.90	2.00	2.10	0.0748	0.0787	0.0827
e	0.50BSC			0.01969BSC		
L	0.30	0.40	0.50	0.0118	0.0157	0.0197

Demo board

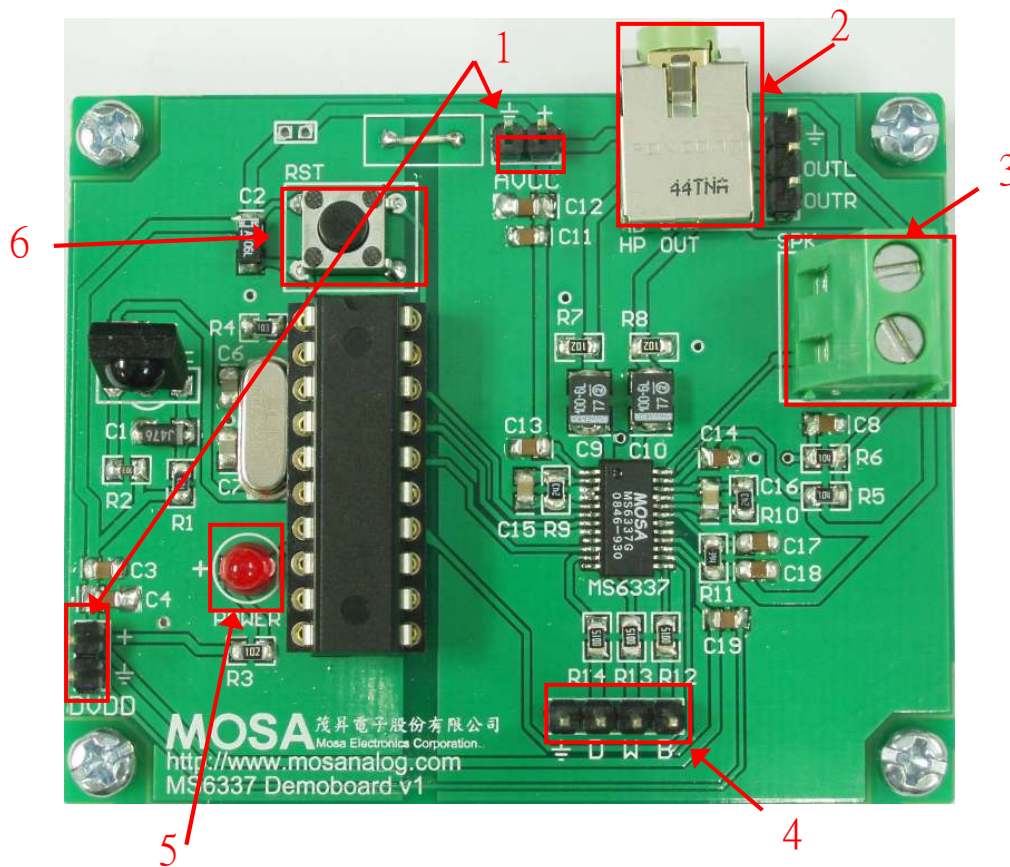

Function description

Label 1: Supply Input
 Supply voltage range is 2.7V to 5.5V.

Label 2: Headphone Jack
 Used 3.5mm diameter of headphone with 32ohm

Label 3: Speaker Output
 Connected to speaker with 8ohm or 4 ohm

Label 4: Digital Signal Input
 Connected to digital audio formats as I2S, Right Justified.

Label 5: LED Indicator
 The LEDs indicate the chip status and IR received status. It is red-dark blink once when the MCU has received the function code correctly.

Label 6: Reset
 All I/O pins are reset to default values. (Initial state: RJF, CAP_UP, DAC_SD, /SD_MODE, SD = 0.)

IR Controller

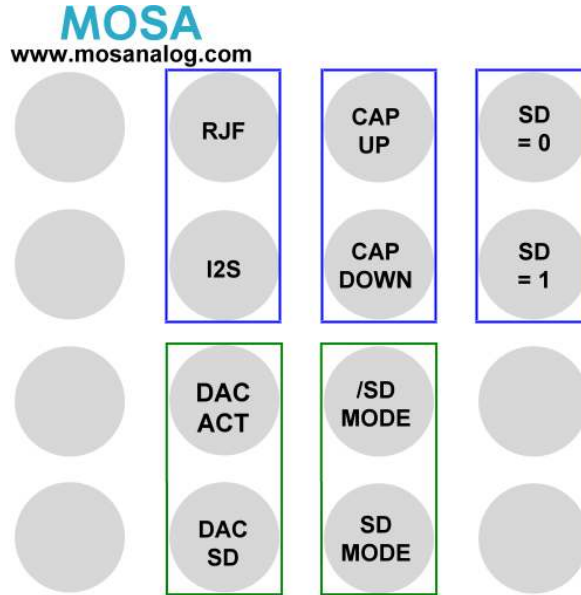

MS6337

ALL FUNCTION CONTROL

Initial state: RJI, CAP_UP, DAC_SD, /SD_MODE, SD = 0.

I2S, RJI: The digital input format keys.

There are two formats can be selected that is I2S and Right justified.

CAP_UP/CAP DOWN : The CAP control key. (This pin is functional only as the system is shutdown.)

CAP_UP : CAP charge.

CAP_DOWN : CAP discharge.

DAC_ACT, DAC_SD : The DAC Shutdown keys.

DAC_ACT : DAC is active.

DAC_SD : DAC is shutdown.

SD_MODE, /SD_MODE: The shutdown mode select keys.

The shutdown mode selects the shutdown logic level

SD=0, SD=1: The shutdown level control keys.

SD_MODE , the device is shutdown when SD = 0.

/SD_MODE , the device is shutdown when SD =1.

Circuit

