

**PLEASE CHECK WWW.MOLEX.COM FOR LATEST PART INFORMATION**

**Part Number:** [5031590600](#)  
**Status:** **Active**  
**Description:** 1.50mm (.059") Pitch CLIK-Mate™ Wire-to-Board PCB Receptacle, Single Row, Through Hole, Vertical, with Peg, 6 Circuits

**Documents:**

[3D Model](#) [Product Specification PS-503159-001 \(PDF\)](#)  
[Drawing \(PDF\)](#) [RoHS Certificate of Compliance \(PDF\)](#)

**General**

Product Family	PCB Receptacles
Series	503159
Application	Wire-to-Board
Product Name	CLIK-Mate™

**Physical**

Circuits (Loaded)	6
Color - Resin	Beige
Durability (mating cycles max)	30
Glow-Wire Compliant	No
Guide to Mating Part	Yes
Keying to Mating Part	Yes
Lock to Mating Part	Yes
Material - Metal	Copper Alloy
Material - Plating Mating	Tin
Material - Plating Termination	Tin
Number of Rows	1
Orientation	Vertical
PCB Locator	Yes
PCB Retention	Yes
PCB Thickness Recommended (in)	0.062 In
PCB Thickness Recommended (mm)	1.60 mm
Packaging Type	Tray
Pitch - Mating Interface (in)	0.059 In
Pitch - Mating Interface (mm)	1.50 mm
Polarized to Mating Part	Yes
Polarized to PCB	Yes
Stackable	No
Temperature Range - Operating	-25°C to +85°C
Termination Interface: Style	Through Hole

**Electrical**

Current - Maximum per Contact	2A
Voltage - Maximum	100V

**Material Info**

**Reference - Drawing Numbers**

Packaging Specification	SPK-503159-001
Product Specification	PS-503159-001, RPS-503159-001, RPS-503159-003
Sales Drawing	SD-503159-001

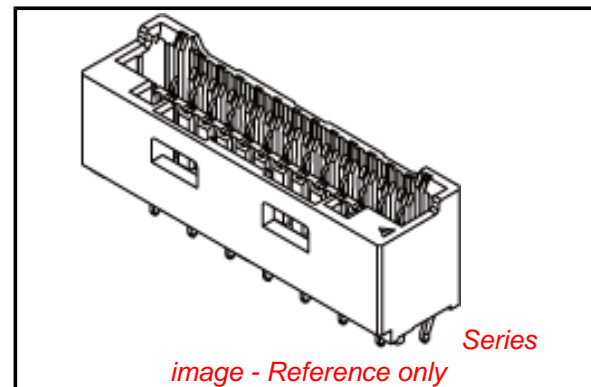

**EU RoHS**

**ELV and RoHS Compliant**  
**REACH SVHC**  
**Contains SVHC: No**  
**Halogen-Free**  
**Status**  
**Not Reviewed**

**China RoHS**



**Need more information on product environmental compliance?**

Email [productcompliance@molex.com](mailto:productcompliance@molex.com)  
 For a multiple part number RoHS Certificate of Compliance, [click here](#)

Please visit the [Contact Us](#) section for any non-product compliance questions.

**Search Parts in this Series**

[503159Series](#)

**Mates With**

[502578](#) Crimp Housing . [502579](#) Crimp Terminal

10 9 8 7 6 5 4 3 2 1

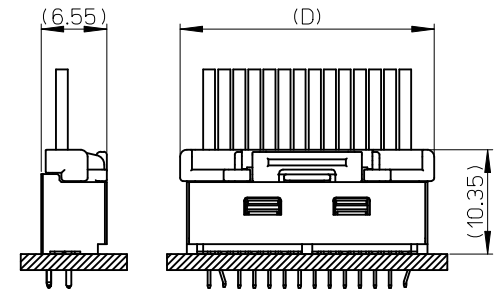
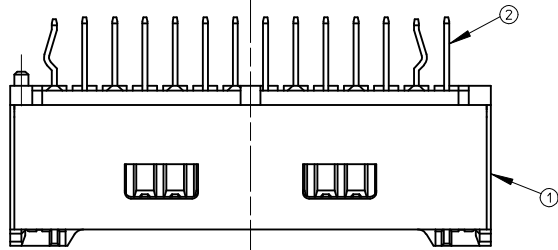

嵌合図 (SCALE 2:1)  
MATED CONNECTORS (SCALE 2:1)

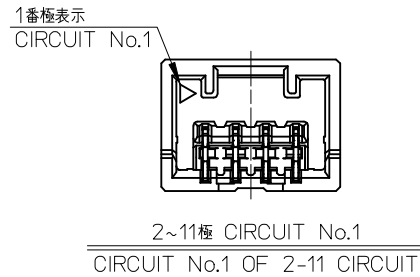
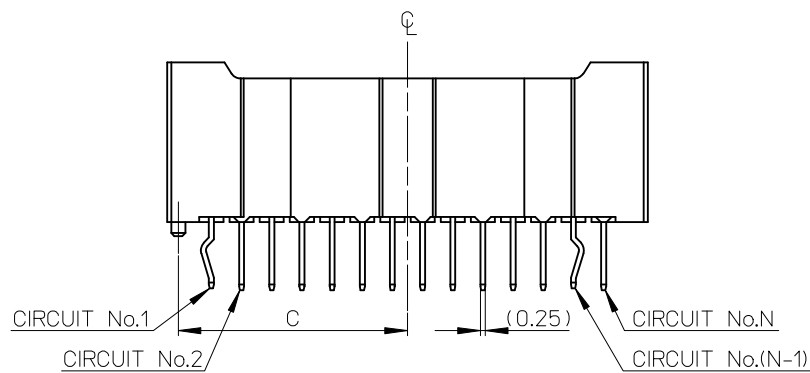
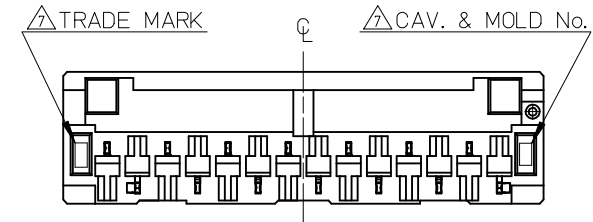
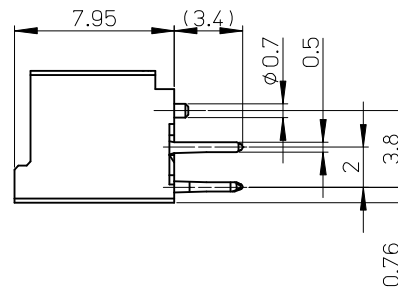
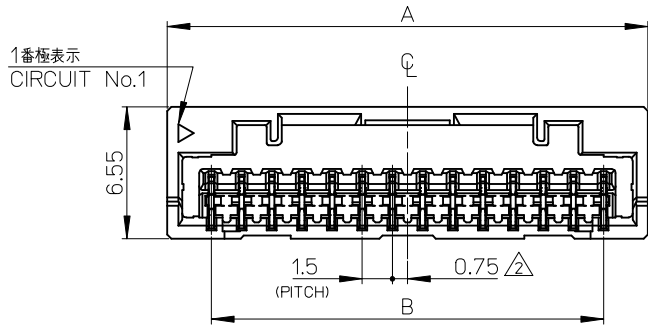

26.8	12.15	21	25.4	503159-15**	15
25.3	11.4	19.5	23.9	503159-14**	14
23.8	10.65	18	22.4	503159-13**	13
22.3	9.9	16.5	20.9	503159-12**	12
20.8	9.15	15	19.4	503159-11**	11
19.3	8.4	13.5	17.9	503159-10**	10
17.8	7.65	12	16.4	503159-09**	9
16.3	6.9	10.5	14.9	503159-08**	8
14.8	6.15	9	13.4	503159-07**	7
13.3	5.4	7.5	11.9	503159-06**	6
11.8	4.65	6	10.4	503159-05**	5
10.3	3.9	4.5	8.9	503159-04**	4
8.8	3.15	3	7.4	503159-03**	3
7.3	2.4	1.5	5.9	503159-02**	2
D	C	B	A	TRAY PACKAGE	CIRCUIT
				ORDER No.	

No.	部品 PART	材料 MATERIAL
①	ハウジング HOUSING	ポリアミド(PA) UL94V-0 POLYAMIDE UL94V-0 色:注記5.参照 COLOR:SEE NOTES 5.
②	ターミナル TERMINAL	銅合金 COPPER ALLOY 錫めっき(1.0μm以上) TIN PLATING OVERALL SURFACES (1.0 MICROMETER MINIMUM) 下地:ニッケルめっき(1.0μm以上) UNDER PLATE:NICKEL OVERALL (1.0 MICROMETER MINIMUM)

REVISED EC NO: J2010-0797 DRWNS:SKUROSE 2009/10/22 CHKD:KASAKAWA 2009/10/22 APPR:NUKITA 2009/10/22	DESCRIPTION	GENERAL TOLERANCES (UNLESS SPECIFIED)		DIMENSION STYLE MM ONLY		SCALE 4:1		DESIGN UNITS METRIC		THIRD ANGLE PROJECTION	
		10 UNDER	±0.2	DRAWN BY SKUROSE	DATE 2008/06/06	TITLE 1.5 W/B CONN. SINGLE DIP ST REC. ASS'Y 2-15CKT					
		10 OVER 30 UNDER	±0.25	CHECKED BY KASAKAWA	DATE 2008/06/06						
		30 OVER	±0.3	APPROVED BY SICHIKAWA	DATE 2008/06/06						
D	REV	ANGULAR ±3 °		MATERIAL NO. SEE TABLE		DOCUMENT NO. SD-503159-001		SHEET NO. 1 OF 2			
		DRAFT WHERE APPLICABLE MUST REMAIN WITHIN DIMENSIONS		THIS DRAWING CONTAINS INFORMATION THAT IS PROPRIETARY TO MOLEX INCORPORATED AND SHOULD NOT BE USED WITHOUT WRITTEN PERMISSION							

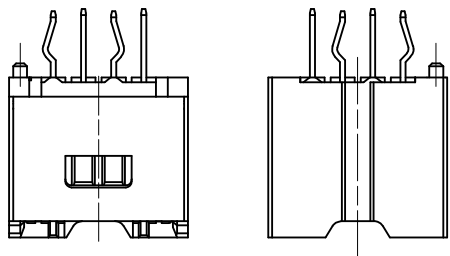

2~5 極形状 (ロック面及び反ロック面)  
 FIGURE OF 2-5 CIRCUIT (LOOK SIDE AND UN-LOCK SIDE)

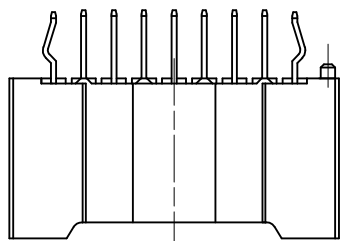

6~10 極形状 (反ロック面)  
 FIGURE OF 6-10 CIRCUIT (UN-LOCK SIDE)

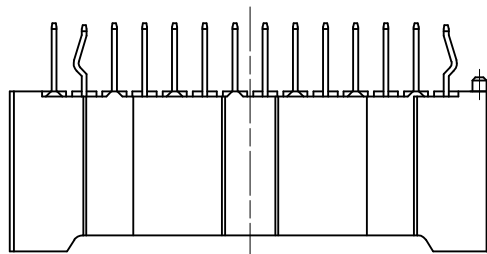

11~15 極形状 (反ロック面)  
 FIGURE OF 11-15 CIRCUIT (UN-LOCK SIDE)

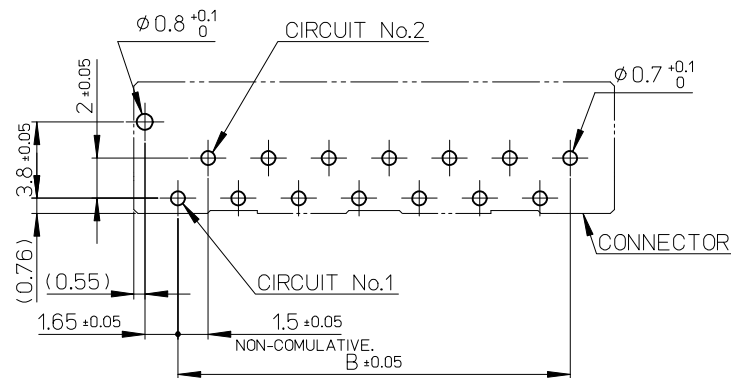

基板取付穴推奨寸法 (マウント面)  
 RECOMMENDED P.C.BOARD  
 HOLE DIMENSION  
 (MOUNTING SIDE)  
 (t=1.6)

NOTES

1. 嵌合相手: 502578 シリーズ  
 MATE WITH : 502578 SERIES.
2. 極数/2 = 偶数に適用  
 APPLY FOR CIRCUIT SIZE/2=EVEN.
3. 端子テール部に錫めっきを使用している為、外觀に摺動痕が付く場合があります。  
 THE WOUND OF FRICTION MIGHT ADHERE TO EXTERNALS  
 BECAUSE THE TIN PLATING IS USED FOR THE TAIL.

4. 製品番号  
 MATERIAL No.  
 503159-\*\*\*

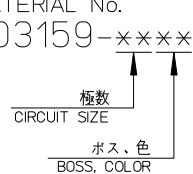

ボス有り		CIRCUIT	No.	COLOR
02~15	0		0	ベージュ BEIGE
	1		1	黒 BLACK
	2		2	赤 RED
	3		3	黄 YELLOW
	4		4	青 BLUE
	5		5	桃 PINK
	6		6	緑 GREEN
	7		7	茶 BROWN
	8		8	橙 ORANGE
	9		9	紫 VIOLET
	4	02	2	水 PALE BLUE

5. 本製品のプラスチック部に黒点・白点等が確認される場合や色合いが異なる場合がありますが、製品性能に影響はありません。  
 THERE IS NO INFLUENCE IN THE PRODUCT PERFORMANCE THOUGH THE BLACK AND WHITE SPOT ETC. MIGHT BE CONFIRMED TO THE PLASTIC PART OF THIS PRODUCT AND THE SHADE MIGHT BE DIFFERENT.

6. ELV及びRoHS適合品  
 ELV AND ROHS COMPLIANT

7. トレードマーク: Mプラス1~2文字のアルファベットにて構成 (例 MXJ)  
 但し "J" は JAPAN を示す。  
 キャビティ番号: 1桁~2桁の数字で構成。  
 金型番号: アルファベット1文字にて構成。  
 TRADE MARK: FORMED BY M AND 1~2 MORE LETTER OF ALPHABET (e.g. MXJ), BUT "J" MEANS JAPAN.  
 CAVITY NO.: FORMED BY 1 DIGIT TO 2 DIGIT NUMBERS.  
 MOLD NO.: FORMED BY 1 LETTER OF ALPHABET.

REVISED EC NO: J2010-0797 DRWNS: KUROSE 2009/10/22 CHKD: KASAKAWA 2009/10/22 APPR: NUKITA 2009/10/22	GENERAL TOLERANCES (UNLESS SPECIFIED)		DIMENSION STYLE MM ONLY		SCALE 4:1	DESIGN UNITS METRIC	THIRD ANGLE PROJECTION
	10 UNDER	± 0.2	DRAWN BY SKUROSE	DATE 2008/06/06	TITLE 1.5 W/B CONN. SINGLE DIP ST REC. ASS'Y 2-15CKT		
	10 OVER 30 UNDER	± 0.25	CHECKED BY KASAKAWA	DATE 2008/06/06			
	30 OVER	± 0.3	APPROVED BY SICHIKAWA	DATE 2008/06/06			
	ANGULAR ± 3 °	DRAFT WHERE APPLICABLE MUST REMAIN WITHIN DIMENSIONS		MATERIAL NO. SEE TABLE	DOCUMENT NO. SD-503159-001		SHEET NO. 2 OF 2
		SIZE A3	THIS DRAWING CONTAINS INFORMATION THAT IS PROPRIETARY TO MOLEX INCORPORATED AND SHOULD NOT BE USED WITHOUT WRITTEN PERMISSION				