

N-Channel Logic Level Enhancement Mode Field Effect Transistor

PRODUCT SUMMARY		
V _{DSS}	I _D	R _{DS(on)} (mΩ) TYP
30V	55A	12.5 @ V _{GS} = 10V
		20 @ V _{GS} = 4.5V

FEATURES

- Super high dense cell design for extremely low R_{DS(ON)}.
- High power and current handling capability.
- TO-220 & TO-263 package.

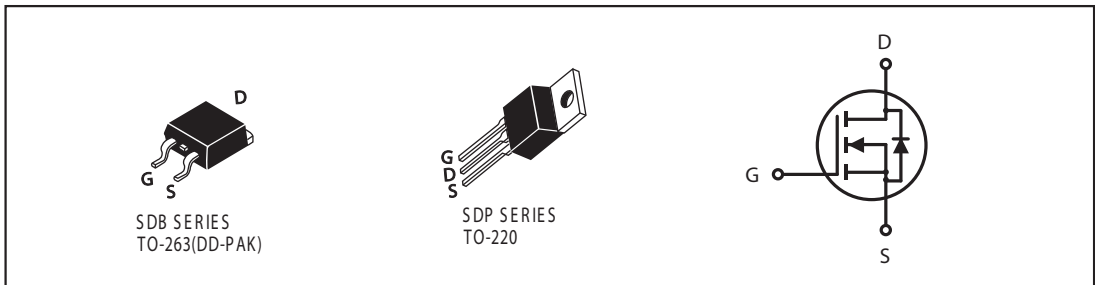

ABSOLUTE MAXIMUM RATINGS (T_C=25°C unless otherwise noted)

Parameter	Symbol	Limit	Unit
Drain-Source Voltage	V _{DS}	30	V
Gate-Source Voltage	V _{GS}	±20	V
Drain Current-Continuous @ T _J =125°C -Pulsed ^a	I _D	55	A
	I _{DM}	140	A
Drain-Source Diode Forward Current	I _S	55	A
Maximum Power Dissipation @ T _C =25°C Derate above 25°C	P _D	75	W
		0.5	W/°C
Operating and Storage Temperature Range	T _J , T _{STG}	-65 to 175	°C

THERMAL CHARACTERISTICS

Thermal Resistance, Junction-to-Case	R _{θJC}	2.5	°C/W
Thermal Resistance, Junction-to-Ambient	R _{θJA}	62.5	°C/W

55N03L

ELECTRICAL CHARACTERISTICS (T_c=25 °C unless otherwise noted)

Parameter	Symbol	Condition	Min	Typ	Max	Unit
OFF CHARACTERISTICS						
Drain-Source Breakdown Voltage	BV _{DSS}	V _{GS} =0V, I _D =250uA	30			V
Zero Gate Voltage Drain Current	I _{DSS}	V _{DS} =24V, V _{GS} =0V			10	uA
Gate-Body Leakage	I _{GSS}	V _{GS} = ±16V, V _{DS} =0V			±100	nA
ON CHARACTERISTICS ^a						
Gate Threshold Voltage	V _{GS(th)}	V _{DS} =V _{GS} , I _D =250uA	1	1.5	3	V
Drain-Source On-State Resistance	R _{DS(ON)}	V _{GS} =10V, I _D =27A		12.5	14	m ohm
		V _{GS} =4.5V, I _D =22A		20	23	m ohm
On-State Drain Current	I _{D(ON)}	V _{GS} =10V, V _{DS} =10V	60			A
Forward Transconductance	g _{FS}	V _{DS} =10V, I _D =27A		32		S
DYNAMIC CHARACTERISTICS ^b						
Input Capacitance	C _{ISS}	V _{DS} =15V, V _{GS} =0V f=1.0MHz		930		pF
Output Capacitance	C _{OSS}			340		pF
Reverse Transfer Capacitance	C _{RSS}			120		pF
SWITCHING CHARACTERISTICS ^b						
Turn-On Delay Time	t _{D(ON)}	V _{DD} =15V, I _D =1A, V _{GS} =10V, R _{GEN} =60 ohm		17	16	ns
Rise Time	t _r			23	250	ns
Turn-Off Delay Time	t _{D(OFF)}			37	90	ns
Fall Time	t _f			20	200	ns
Total Gate Charge	Q _g	V _{DS} =15V, I _D =27.5A, V _{GS} =10V		26.1	35	nC
		V _{DS} =15V, I _D =27.5A, V _{GS} =4.5V		13.7	16.5	nC
Gate-Source Charge	Q _{gs}	V _{DS} =15V, I _D =27.5A, V _{GS} =10V		5.4		nC
Gate-Drain Charge	Q _{gd}			4.6		nC

55N03L

ELECTRICAL CHARACTERISTICS ($T_c=25^{\circ}\text{C}$ unless otherwise noted)

Parameter	Symbol	Condition	Min	Typ	Max	Unit
DRAIN-SOURCE DIODE CHARACTERISTICS ^a						
Diode Forward Voltage	V_{SD}	$V_{GS} = 0V, I_s = 26A$		0.9	1.3	V

Notes

a. Pulse Test: Pulse Width $\leq 300\mu\text{s}$, Duty Cycle $\leq 2\%$.

b. Guaranteed by design, not subject to production testing.

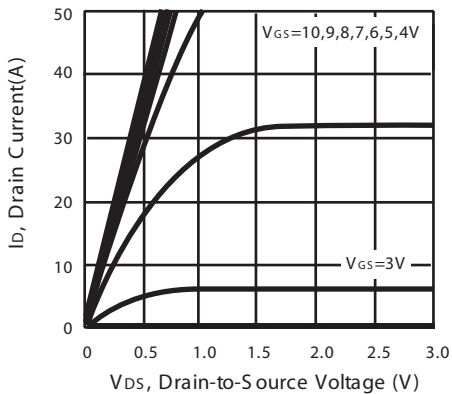

Figure 1. Output Characteristics

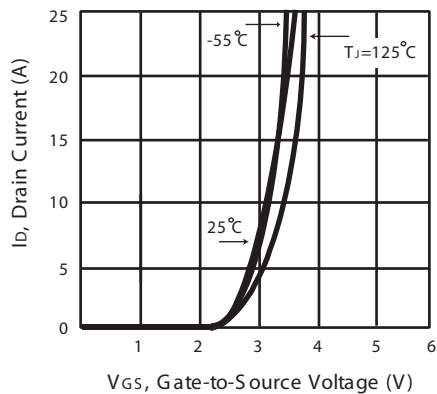

Figure 2. Transfer Characteristics

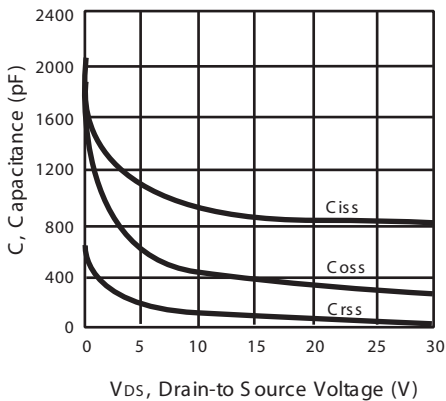

Figure 3. Capacitance

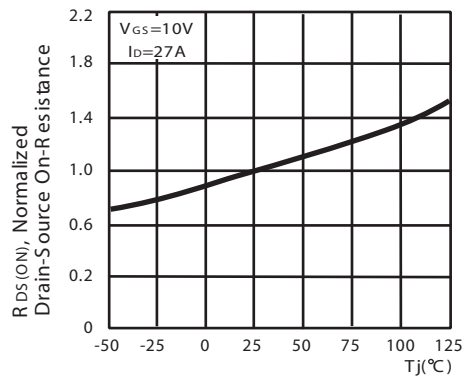

Figure 4. On-Resistance Variation with Temperature

SDP/B55N03L

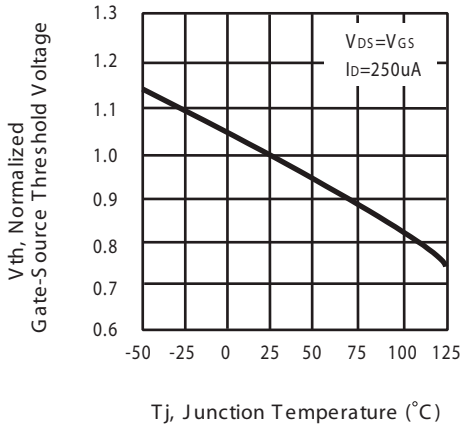

Figure 5. Gate Threshold Variation with Temperature

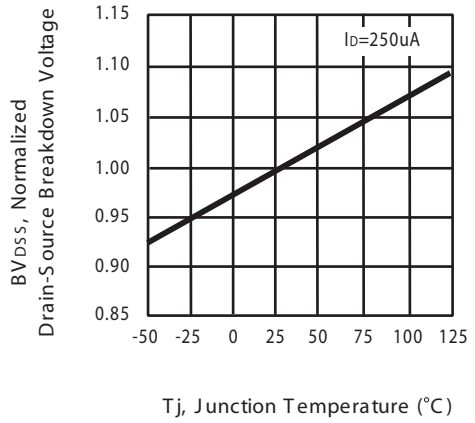

Figure 6. Breakdown Voltage Variation with Temperature

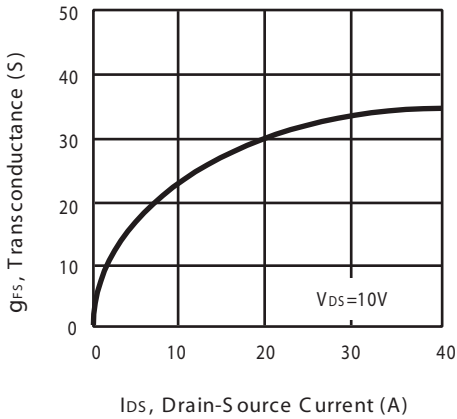

Figure 7. Transconductance Variation with Drain Current

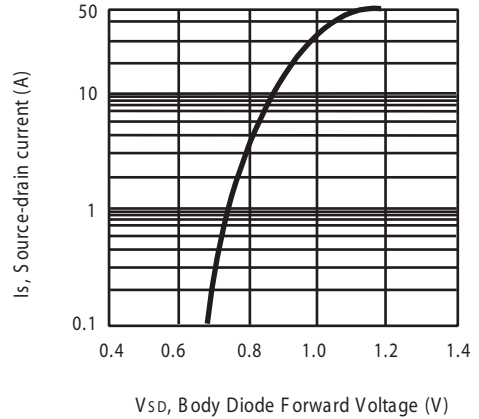

Figure 8. Body Diode Forward Voltage Variation with Source Current

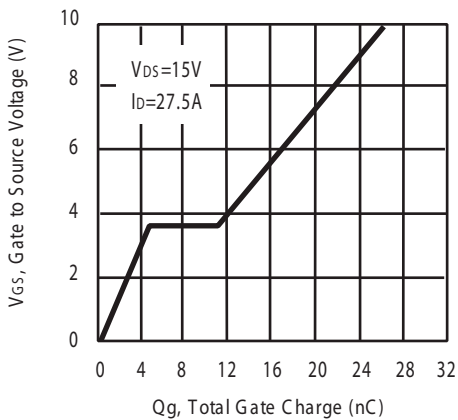

Figure 9. Gate Charge

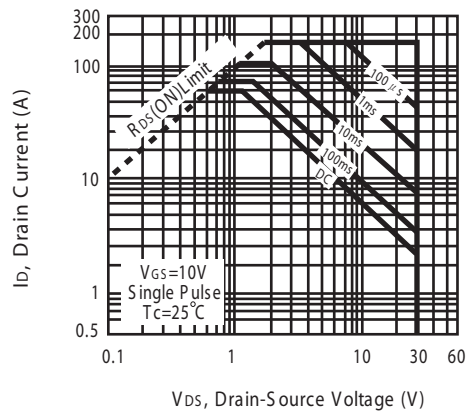

Figure 10. Maximum Safe Operating Area

SDP/B55N03L

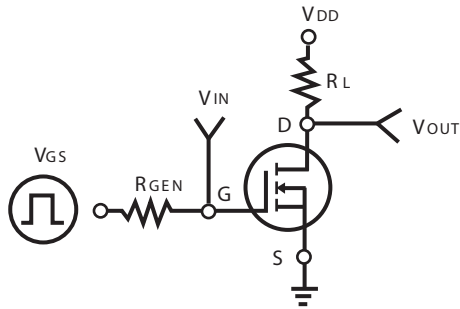

Figure 11. Switching Test Circuit

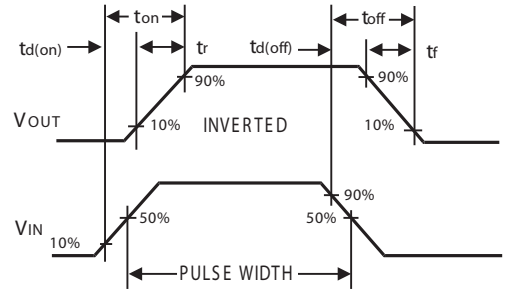

Figure 12. Switching Waveforms

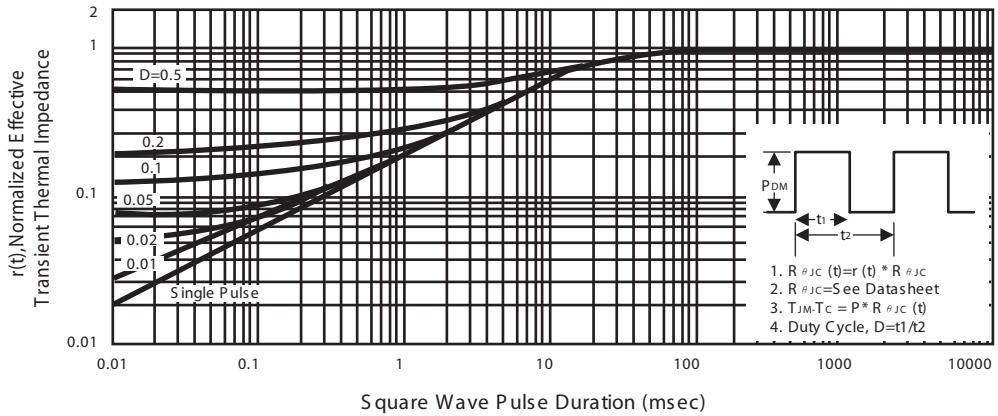

Figure 13. Normalized Thermal Transient Impedance Curve