

PLEASE CHECK WWW.MOLEX.COM FOR LATEST PART INFORMATION

Part Number: [0887689810](#)
Status: **Active**
Overview: high definition multimedia interface hdmi
Description: HDMI*-to-HDMI* Cable Assembly, 28 AWG, 2.0m (6.56') Length

Documents:

[Drawing \(PDF\)](#) [RoHS Certificate of Compliance \(PDF\)](#)
[Product Specification PS-88768-002 \(PDF\)](#)

General

Product Family	Cable Assemblies
Series	88768
Connector to Connector	HDMI*-to-HDMI*
Overview	<u>high definition multimedia interface hdmi</u>
Product Name	HDMI*

Physical

Cable Length	2.0m (6.56')
Circuits (Loaded)	19
Color - Resin	Natural
Gender	Male-Male
Lock to Mating Part	Yes
Material - Metal	High Performance Alloy (HPA)
Material - Plating Mating	Gold
Material - Plating Termination	Tin
Material - Resin	High Temperature Thermoplastic, Low Density Polyethylene
Packaging Type	Bag
Pitch - Mating Interface (in)	0.039 In
Pitch - Mating Interface (mm)	1.00 mm
Plating min: Mating (µin)	32
Plating min: Mating (µm)	0.8
Plating min: Termination (µin)	50.8
Plating min: Termination (µm)	1.27
Single Ended	No
Termination Interface: Style	Through Hole
Wire Insulation Diameter	N/A
Wire Size AWG	28
Wire/Cable Type	Round

Electrical

Current - Maximum per Contact	0.5A
Impedance	100 ohms
Shielded	Yes
Voltage - Maximum	40V

Material Info

Reference - Drawing Numbers

Product Specification	PS-88768-002
Sales Drawing	SD-887689810

*High Definition Multimedia Interface and HDMI are trademarks of HDMI Licensing, LLC.

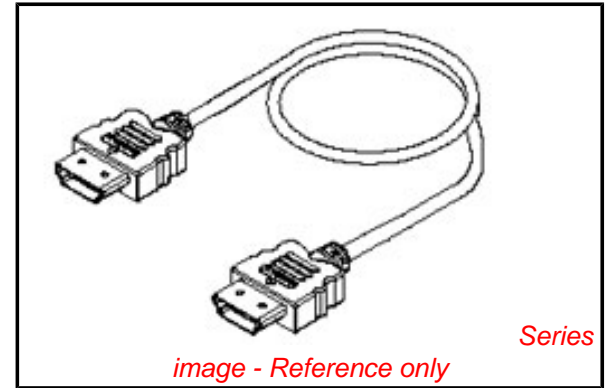

EU RoHS

ELV and RoHS Compliant
REACH SVHC
 Not Reviewed
Halogen-Free
Status

China RoHS



Not Reviewed

Need more information on product environmental compliance?

Email productcompliance@molex.com
 For a multiple part number RoHS Certificate of Compliance, [click here](#)

Please visit the [Contact Us](#) section for any non-product compliance questions.

Search Parts in this Series
 88768Series

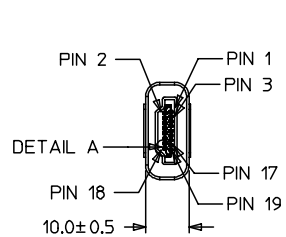

HDMI(M)

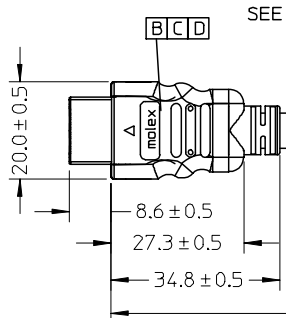
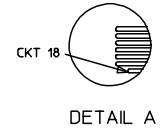

LENGTH

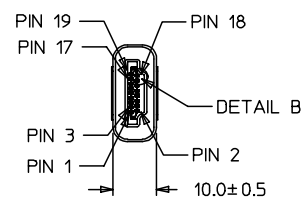
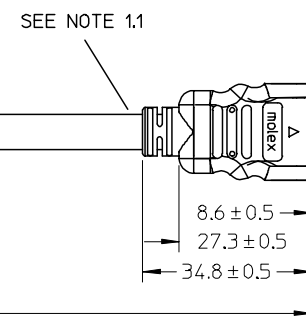

HDMI(M)

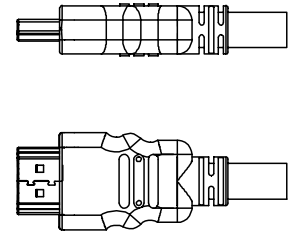
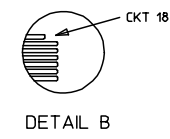

BACK SIDE

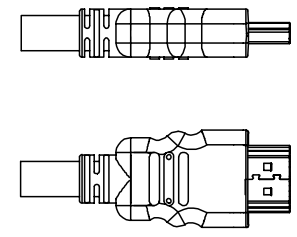

BACK SIDE

88768-9830	HDMI TO HDMI CABLE ASS'Y,5M	5000 ± 100	BLACK	7.3MM(TMDS - AWG#28)	887808610
88768-9820	HDMI TO HDMI CABLE ASS'Y,3M	3000 ± 80	BLACK	7.3MM(TMDS - AWG#28)	887808610
88768-9810	HDMI TO HDMI CABLE ASS'Y,2M	2000 ± 60	BLACK	7.3MM(TMDS - AWG#28)	887808610
88768-9800	HDMI TO HDMI CABLE ASS'Y,1M	1000 ± 30	BLACK	7.3MM(TMDS - AWG#28)	887808610
MX P/N	DESCRIPTION	LENGTH	CABLE COLOR	CABLE OD	CABLE P/N

ENTER DESCRIPTION
 EC NO: DG2006-0144
 T1 DRWN: JFZHENG 2005/12/27
 CHKD: 2005/12/30
 APPR: DQLUO 2006/01/16

QUALITY SYMBOLS
 ▽=0
 ◻=0

GENERAL TOLERANCES (UNLESS SPECIFIED)

	mm	INCH
4 PLACES	± ---	± ---
3 PLACES	± ---	± ---
2 PLACES	± ---	± ---
1 PLACE	± ---	± ---

ANGULAR ± ---°

DRAFT WHERE APPLICABLE
 MUST REMAIN
 WITHIN DIMENSIONS

DIMENSION STYLE
 MM ONLY

SCALE

DESIGN UNITS
 METRIC

THIRD ANGLE
 PROJECTION

DRAWN BY DATE
 JFZHENG 2005/12/26

CHECKED BY DATE
 JFZHENG 2005/12/26

APPROVED BY DATE
 DQLUO 2005/12/26

TITLE
 AWG28 HDMI TO HDMI
 CABLE ASS'Y

MOLEX MOLEX INCORPORATED

MATERIAL NO. DOCUMENT NO. SHEET NO.
 ENTER PART SD-887689820 1 OF 00

SIZE
 A 4 THIS DRAWING CONTAINS INFORMATION THAT IS PROPRIETARY TO MOLEX INCORPORATED AND SHOULD NOT BE USED WITHOUT WRITTEN PERMISSION

NOTE:

1. OVMOLD SPECIFICATION:
 - 1.1 HDMI INNERMOLD WITH BK PVC 887800019.
 - 1.2 HDMI OVERMOLD WITH PVC 887800150.
2. MECHANICAL SPECIFICATION:

CABLE SHOULD STAND THE PULL FORCE 89-111N FOR 30 SECONDS WITH NO VISIBLE TERMINATION DAMAGE.

3. PRODUCT ELECTRICAL SPECIFICATION:
 - 3.1 DIELECTRIC STRENGTH.
 - 3.2 INSULATION RESISTANCE
 - 3.3 CONDUCTIVE RESISTANCE.
 - 3.4 TMDS Signals Time Domain Impedence
 - 3.5 TMDS Signals Time Domain Crosstalk:FEXT
 - 3.6 TMDS Signals Skew
 - 3.7 Attenuation(

REFER TO ES-002 ELECTRICAL SPECIFICATION FOR DETAILS.

- 4.CABLE CONSTRUCTION

(AWG#28*1P+D)*4 + AWG#28*1P + AWG#28*5C, 7.3MMOD
5. THIS PRODUCT MUST MEET ROHS COMPLIANCE.

WIRE DIAGRAM:

SHIELD	SHIELD	OVERALL SHIELD	GROUND
PIN 19	PIN 19	PINK	HOT PLUG DETECT
PIN 18	PIN 18	ORANGE	+5V POWER
PIN 17	PIN 17	YELLOW	DDC/CEC GROUND
PIN 16	PIN 16	WHITE	SDA
PIN 15	PIN 15	RED	SCL
PIN 14	PIN 14	VIOLET	RESERVED
PIN 13	PIN 13	GRAY	CEC
PIN 12	PIN 12	WHITE	TMDS CLOCK-
PIN 11	PIN 11	BRAID	TMDS CLOCK SHIELD
PIN 10	PIN 10	WHITE/BLACK	TMDS CLOCK+
PIN 9	PIN 9	WHITE	TMDS DATA 0-
PIN 8	PIN 8	BRAID	TMDS DATA 0 SHIELD
PIN 7	PIN 7	WHITE/BLUE	TMDS DATA 0+
PIN 6	PIN 6	WHITE	TMDS DATA 1-
PIN 5	PIN 5	BRAID	TMDS DATA 1 SHIELD
PIN 4	PIN 4	WHITE/GREEN	TMDS DATA 1+
PIN 3	PIN 3	WHITE	TMDS DATA 2-
PIN 2	PIN 2	BRAID	TMDS DATA 2 SHIELD
PIN 1	PIN 1	WHITE/RED	TMDS DATA 2+
HDMI	HDMI	COLOR	CABLE FUNCTION

D	SMALL METAL PLATE 47152-6009		2
C	HDMI METAL CAN 47152-4001		2
B	HDMI HOUSING ASSY' 47152-1100		2
A	HDMI SINGLE LINK CABLE (SEE TABLE)		1
ITEM	DESCRIPTION	L	QTY.

ENTER DESCRIPTION EC NO: DG2006-0144 TDRWN: JFZHENG 2005/12/27 CHKD: 2005/12/30 APPR: DQLUO 2006/01/16	QUALITY SYMBOLS =0 =0	GENERAL TOLERANCES (UNLESS SPECIFIED)		DIMENSION STYLE		SCALE	DESIGN UNITS	THIRD ANGLE PROJECTION	
			mm	INCH	MM ONLY		---	METRIC	
		4 PLACES	±---	±---	DRAWN BY	DATE	TITLE		
		3 PLACES	±---	±---	JFZHENG	2005/12/26	AWG28 HDMI TO HDMI CABLE ASS'Y		
2 PLACES	±---	±---	CHECKED BY	DATE					
1 PLACE	±---	±---	JFZHENG	2005/12/26					
ANGULAR ±---°		APPROVED BY		DATE	MOLEX MOLEX INCORPORATED				
		DQLUO		2005/12/26					
DRAFT WHERE APPLICABLE MUST REMAIN WITHIN DIMENSIONS		MATERIAL NO.		DOCUMENT NO.	SHEET NO.				
		ENTER PART		SD-887689820	2 OF 00				
		SIZE		THIS DRAWING CONTAINS INFORMATION THAT IS PROPRIETARY TO MOLEX INCORPORATED AND SHOULD NOT BE USED WITHOUT WRITTEN PERMISSION					
		A 4							