



Micro Commercial Components

Micro Commercial Components  
 20736 Marilla Street Chatsworth  
 CA 91311  
 Phone: (818) 701-4933  
 Fax: (818) 701-4939

# DTC144EKA

## NPN Digital Transistors

### Features

- Built-in bias resistors enable the configuration of an inverter circuit without connecting external input resistors
- The bias resistors consist of thin-film resistors with complete isolation to allow negative biasing of the input. They also have the advantage of almost completely eliminating parasitic effects.
- Only the on/off conditions need to be set for operation, making device design easy

### Absolute maximum ratings @ 25°C

Symbol	Parameter	Min	Typ	Max	Unit
$V_{CC}$	Supply voltage	---	50	---	V
$V_{IN}$	Input voltage	-10	---	40	V
$I_O$	Output current	---	100	---	mA
$P_d$	Power dissipation	---	200	---	mW
$T_j$	Junction temperature	---	150	---	°C
$T_{sig}$	Storage temperature	-55	---	150	°C

### Electrical Characteristics @ 25°C

Symbol	Parameter	Min	Typ	Max	Unit
$V_{I(off)}$	Input voltage ( $V_{CC}=5V, I_O=100 \mu A$ )	---	---	0.5	V
$V_{I(on)}$	Input voltage ( $V_O=0.3V, I_O=2mA$ )	3.0	---	---	V
$V_{O(on)}$	Output voltage ( $I_O/I_I=10mA/0.5mA$ )	---	---	0.3	V
$I_I$	Input current ( $V_I=5V$ )	---	---	0.18	mA
$I_{O(off)}$	Output current ( $V_{CC}=50V, V_I=0$ )	---	---	0.5	$\mu A$
$G_I$	DC current gain ( $V_O=5V, I_O=5mA$ )	68	---	---	
$R_1$	Input resistance	32.9	47	61.1	K $\Omega$
$R_2/R_1$	Resistance ratio	0.8	1.0	1.2	
$f_T$	Transition frequency ( $V_{CE}=10V, I_E=5mA, f=100MHz$ )	---	250	---	MHz

#### Equivalent circuit

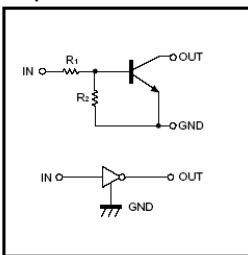

### SOT-23-3L

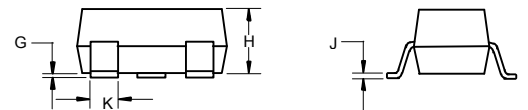
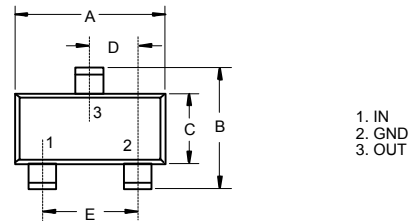

DIM	INCHES		MM		NOTE
	MIN	MAX	MIN	MAX	
A	.113	.117	2.87	2.97	
B	.108	.112	2.75	2.85	
C	.061	.065	1.55	1.65	
D	.036	.038	.925	.975	
E	.073	.077	1.85	1.95	
G	.0016	.0039	.04	.100	
H	.044	.049	1.12	1.25	
J	.006	.007	.14	.17	
K	.013	.015	.34	.37	

#### Suggested Solder Pad Layout

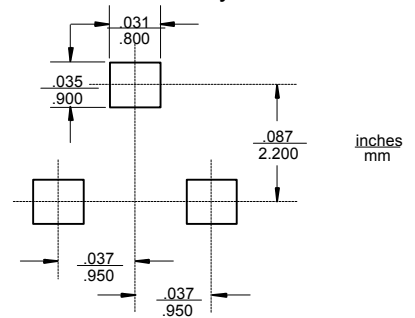

# DTC144EKA



Micro Commercial Components

## ● Electrical characteristic curves

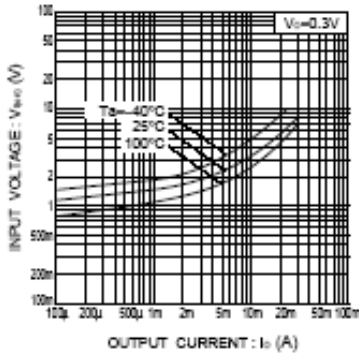

Fig.1 Input voltage vs. output current (ON characteristics)

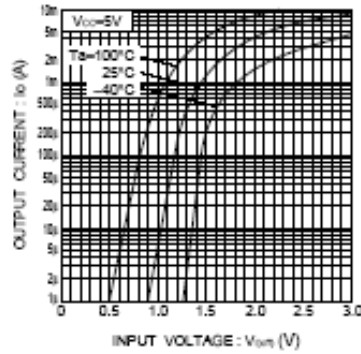

Fig.2 Output current vs. input voltage (OFF characteristics)

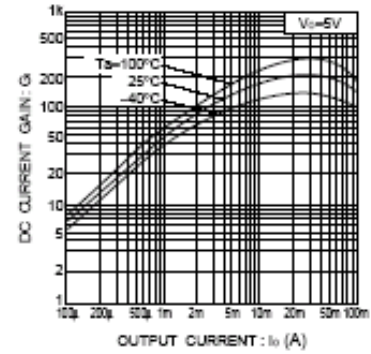

Fig.3 DC current gain vs. output current

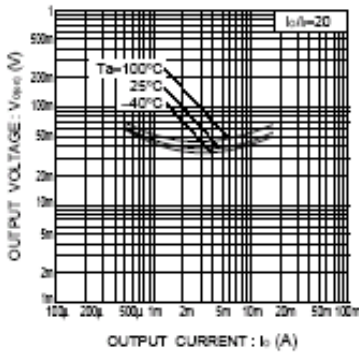

Fig.4 Output voltage vs. output current