

### Low Power RTC with Battery-Backed SRAM and Embedded Temp Compensation $\pm 5\text{ppm}$ with Auto Daylight Saving

The ISL12023 device is a low power real time clock with an embedded Temp sensor for oscillator compensation, clock/calendar, power fail, low battery monitor, brownout indicator, single periodic or polled alarms, intelligent battery-backup switching, Battery Reseal™ function and 128 bytes of battery-backed user SRAM.

The oscillator uses an external, low-cost 32.768kHz crystal. The real time clock tracks time with separate registers for hours, minutes, and seconds. The device has calendar registers for date, month, year and day of the week. The calendar is accurate through 2099, with automatic leap year correction.

Daylight Savings time adjustment is done automatically, using parameters entered by the user. Power fail and battery monitors offer user-selectable trip levels. A time stamp function records the time and date of switchover from  $V_{DD}$  to  $V_{BAT}$  power, and also from  $V_{BAT}$  to  $V_{DD}$  power.

### Pinout

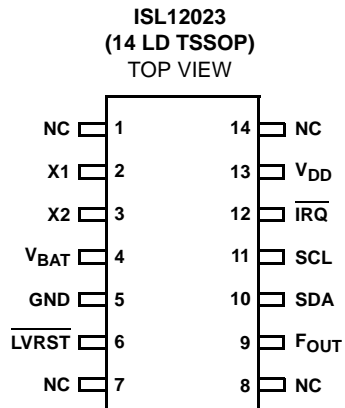

### Features

- Real Time Clock/Calendar
  - Tracks Time in Hours, Minutes and Seconds
  - Day of the Week, Day, Month and Year
- On-chip Oscillator Compensation Over the Operating Temp Range
  - $\pm 5\text{ppm}$  Over  $-40^{\circ}\text{C}$  to  $+85^{\circ}\text{C}$
- 10-bit Digital Temperature Sensor Output
  - $\pm 2^{\circ}\text{C}$  Accuracy
- Customer Programmable Day Light Saving Time
- Clock Output with 15 Selectable Frequencies
- 1 Alarm
  - Settable to the Second, Minute, Hour, Day of the Week, Day, or Month
  - Single Event or Pulse Interrupt Mode
- Battery Reseal™ Function to Extend Battery Shelf Life
- Automatic Backup to Battery or Super Capacitor
  - Operation to  $V_{BAT} = 1.8\text{V}$
  - $1.0\mu\text{A}$  Battery Supply Current
- Battery Status Monitor
  - 2 User Programmable Levels
  - Seven Selectable Voltages for Each Level
- Power Status Brownout Monitor
  - Six Selectable Trip Levels, from 2.295V to 4.675V
- Oscillator Failure Detection
- Time Stamp for First  $V_{DD}$  to  $V_{BAT}$ , and Last  $V_{BAT}$  to  $V_{DD}$
- 128 Bytes Battery-Backed User SRAM
- Separate FOUT,  $\overline{IRQ}$ , and  $\overline{LVRST}$  Outputs
- I<sup>2</sup>C Bus™
  - 400kHz Clock Frequency
- 14 Ld TSSOP Package
- Pb-Free (RoHS Compliant)

### Applications

- Utility Meters
- POS Equipment
- Medical Devices
- Security Systems
- Vending Machines
- White Goods
- Printers and Copiers

**Ordering Information**

| PART NUMBER (Note) | PART MARKING | V <sub>DD</sub> RANGE (V) | TEMP RANGE (°C) | PACKAGE (Pb-Free) | PKG. DWG. # |
|--------------------|--------------|---------------------------|-----------------|-------------------|-------------|
| ISL12023IVZ*       | 12023 IVZ    | 2.7 to 5.5                | -40 to +85      | 14 Ld TSSOP       | M14.173     |

\*Add "-T" suffix for tape and reel. Please refer to TB347 for details on reel specifications.

NOTE: These Intersil Pb-free plastic packaged products employ special Pb-free material sets, molding compounds/die attach materials, and 100% matte tin plate plus anneal (e3 termination finish, which is RoHS compliant and compatible with both SnPb and Pb-free soldering operations). Intersil Pb-free products are MSL classified at Pb-free peak reflow temperatures that meet or exceed the Pb-free requirements of IPC/JEDEC J STD-020

**Block Diagram**

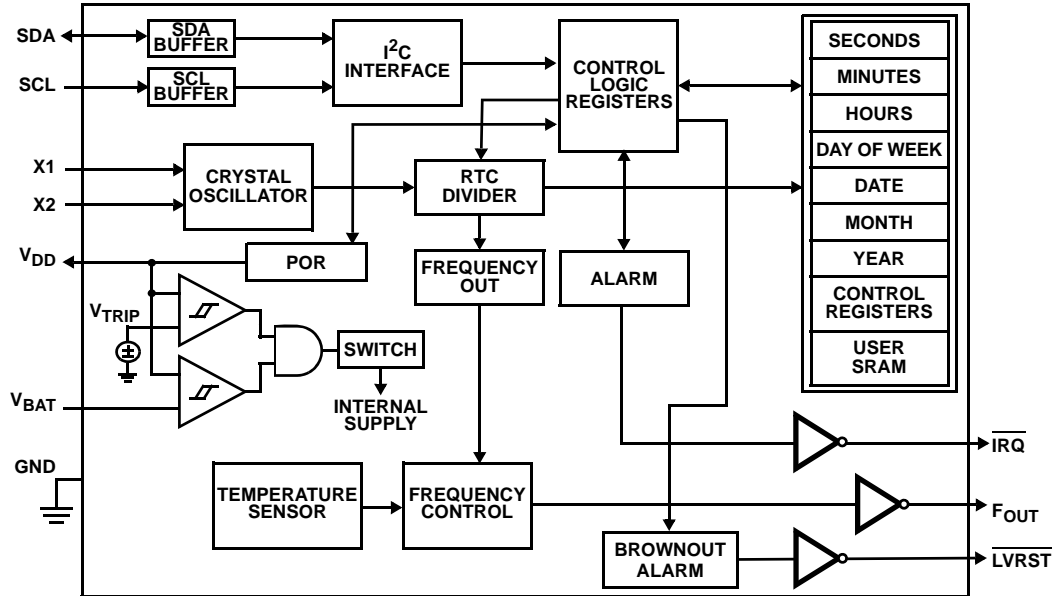

**Pin Descriptions**

| PIN NUMBER  | SYMBOL           | DESCRIPTION   |
|-------------|------------------|---|
| 1, 7, 8, 14 | NC               | <b>No connect.</b> Do not connect.  |
| 2           | X1               | <b>Crystal Input.</b> The X1 pin is the input of an inverting amplifier and is intended to be connected to one pin of an external 32.768kHz quartz crystal. X1 can also be driven directly from a 32.768kHz source.               |
| 3           | X2               | <b>Crystal Output.</b> The X2 pin is the output of an inverting amplifier and is intended to be connected to one pin of an external 32.768kHz quartz crystal. X2 should be left open when X1 is driven from external source.      |
| 4           | V <sub>BAT</sub> | <b>Backup Supply.</b> This input provides a backup supply voltage to the device. V <sub>BAT</sub> supplies power to the device in the event that the V <sub>DD</sub> supply fails. This pin should be tied to ground if not used. |
| 5           | GND              | <b>Ground.</b>  |
| 6           | LVRST            | <b>Low Voltage Reset</b> pin for VCC Brownout Mode. Open drain configuration  |
| 9           | F <sub>OUT</sub> | <b>Frequency Output.</b> Frequency selectable through Control Register. Open drain configuration.   |
| 10          | SDA              | <b>Serial Data.</b> SDA is a bi-directional pin used to transfer serial data into and out of the device. It has an open drain output and may be wire OR'ed with other open drain or open collector outputs.                       |
| 11          | SCL              | <b>Serial Clock.</b> The SCL input is used to clock all serial data into and out of the device.   |
| 12          | IRQ              | <b>Interrupt Output.</b> Provides active low interrupt signal. Open drain configuration.  |
| 13          | V <sub>DD</sub>  | <b>Power Supply.</b>  |

**Absolute Maximum Ratings**

|   |                                 |
|---|---------------------------------|
| Voltage on V <sub>DD</sub> , V <sub>BAT</sub> and $\overline{\text{IRQ}}/\text{F}_{\text{OUT}}$ pins<br>(respect to ground) . . . . . | -0.3V to 6.0V                   |
| Voltage on SCL and SDA pins<br>(respect to ground) . . . . .  | -0.3V to V <sub>DD</sub> + 0.3V |
| Voltage on X1 and X2 pins<br>(respect to ground) . . . . .  | -0.3V to 2.5V                   |
| <b>ESD Rating</b>   |                                 |
| Human Body Model (Per MIL-STD-883 Method 3014) . . . . .  | >3kV                            |
| Machine Model . . . . .   | >300V                           |

**Thermal Information**

|                                      |   |
|--------------------------------------|---|
| Thermal Resistance (Typical, Note 1) | $\theta_{\text{JA}}$ (°C/W)   |
| 14 Ld TSSOP . . . . .                | 100   |
| Storage Temperature . . . . .        | -65°C to +150°C   |
| Pb-free Reflow Profile . . . . .     | see link below<br><a href="http://www.intersil.com/pbfree/Pb-FreeReflow.asp">http://www.intersil.com/pbfree/Pb-FreeReflow.asp</a> |

**CAUTION:** Do not operate at or near the maximum ratings listed for extended periods of time. Exposure to such conditions may adversely impact product reliability and result in failures not covered by warranty.

**NOTE:**

- $\theta_{\text{JA}}$  is measured with the component mounted on a high effective thermal conductivity test board in free air. See Tech Brief TB379 for details.

**DC Operating Characteristics-RTC** Test Conditions: V<sub>DD</sub> = +2.7V to +5.5V, T<sub>A</sub> = -40°C to +85°C, unless otherwise stated.

| SYMBOL                             | PARAMETER   | CONDITIONS   | MIN<br>(Note 9) | TYP<br>(Note 5) | MAX<br>(Note 9) | UNITS | NOTES |
|------------------------------------|---|--|-----------------|-----------------|-----------------|-------|-------|
| V <sub>DD</sub>                    | Main Power Supply   | (Note 11)  | 2.7             |                 | 5.5             | V     |       |
| V <sub>BAT</sub>                   | Battery Supply Voltage  | (Note 11)  | 1.8             |                 | 5.5             | V     | 2     |
| I <sub>DD1</sub>                   | Supply Current. (I <sup>2</sup> C not Active,<br>Temperature Conversion not Active,<br>F <sub>OUT</sub> not Active) | V <sub>DD</sub> = 5V   |                 | 4.1             | 7               | μA    | 3, 4  |
|                                    |   | V <sub>DD</sub> = 3V   |                 | 3.5             | 6               | μA    | 3, 4  |
| I <sub>DD2</sub>                   | Supply Current. (I <sup>2</sup> C Active, Temperature<br>Conversion not Active, F <sub>OUT</sub> not Active)        | V <sub>DD</sub> = 5V   |                 | 200             | 500             | μA    | 3, 4  |
| I <sub>DD3</sub>                   | Supply Current. (I <sup>2</sup> C not Active,<br>Temperature Conversion Active, F <sub>OUT</sub><br>not Active)     | V <sub>DD</sub> = 5V   |                 | 120             | 400             | μA    | 3, 4  |
| I <sub>BAT</sub>                   | Battery Supply Current  | V <sub>DD</sub> = 0V, V <sub>BAT</sub> = 3V,<br>T <sub>A</sub> = +25°C |                 | 1.0             | 1.6             | μA    | 3     |
|                                    |   | V <sub>BAT</sub> = 3V  |                 | 1.0             | 5.0             | μA    | 3     |
| I <sub>BATLKG</sub>                | Battery Input Leakage   | V <sub>DD</sub> = 5.5V, V <sub>BAT</sub> = 1.8V                        |                 |                 | 100             | nA    |       |
| I <sub>LI</sub>                    | Input Leakage Current on SCL  |  | -1.0            | ±0.1            | 1.0             | μA    |       |
| I <sub>LO</sub>                    | I/O Leakage Current on SDA  |  | -1.0            | ±0.1            | 1.0             | μA    |       |
| V <sub>BATM</sub>                  | Battery Level Monitor Threshold   |  | -100            |                 | +100            | mV    |       |
| V <sub>PBM</sub>                   | Brownout Level Monitor Threshold  |  | -100            |                 | +100            | mV    |       |
| V <sub>TRIP</sub>                  | V <sub>BAT</sub> Mode Threshold   | (Note 11)  | 2.0             | 2.2             | 2.4             | V     |       |
| V <sub>TRIPHYS</sub>               | V <sub>TRIP</sub> Hysteresis  |  |                 | 30              |                 | mV    | 7     |
| V <sub>BATHYS</sub>                | V <sub>BAT</sub> Hysteresis   |  |                 | 50              |                 | mV    | 7     |
| ΔF <sub>outT</sub>                 | Frequency Stability vs Temperature  | 2.7V ≤ V <sub>DD</sub> ≤ 3.6V,   | -5              |                 | +5              | ppm   | 10    |
| ΔF <sub>outV</sub>                 | Frequency Stability vs Voltage  | 2.7V ≤ V <sub>DD</sub> ≤ 3.6V  | -3              |                 | +3              | ppm   | 10    |
| ΔAT <sub>LSB</sub>                 | AT Sensitivity per LSB  | BETA (3:0) = 1000  | 0.5             | 1               | 2               | ppm   | 10    |
| Temp                               | Temperature Sensor Accuracy   | V <sub>DD</sub> = V <sub>BAT</sub> = 3.3 V                             |                 | ±2              |                 | °C    | 7     |
| <b>IRQ, LVRST, F<sub>OUT</sub></b> |   |  |                 |                 |                 |       |       |
| V <sub>OL</sub>                    | Output Low Voltage  | V <sub>DD</sub> = 5V, I <sub>OL</sub> = 3mA                            |                 |                 | 0.4             | V     |       |
|                                    |   | V <sub>DD</sub> = 2.7V, I <sub>OL</sub> = 1mA                          |                 |                 | 0.4             | V     |       |

# ISL12023

## Power-Down Timing

Test Conditions:  $V_{DD} = +2.7$  to  $+5.5V$ ,  $T_A = -40^\circ C$  to  $+85^\circ C$ , unless otherwise stated.

| SYMBOL        | PARAMETER                   | CONDITIONS | MIN<br>(Note 9) | TYP<br>(Note 5) | MAX<br>(Note 9) | UNITS | NOTES |
|---------------|-----------------------------|------------|-----------------|-----------------|-----------------|-------|-------|
| $V_{DD\ SR-}$ | $V_{DD}$ Negative Slew Rate |            |                 |                 | 10              | V/ms  | 6     |

## I<sup>2</sup>C Interface Specifications

Test Conditions:  $V_{DD} = +2.7$  to  $+5.5V$ ,  $T_A = -40^\circ C$  to  $+85^\circ C$ , unless otherwise specified.

| SYMBOL       | PARAMETER  | TEST CONDITIONS   | MIN<br>(Note 9)      | TYP<br>(Note 5) | MAX<br>(Note 9)     | UNITS | NOTES |
|--------------|--|---|----------------------|-----------------|---------------------|-------|-------|
| $V_{IL}$     | SDA and SCL Input Buffer LOW Voltage                             |   | -0.3                 |                 | $0.3 \times V_{DD}$ | V     |       |
| $V_{IH}$     | SDA and SCL Input Buffer HIGH Voltage                            |   | $0.7 \times V_{DD}$  |                 | $V_{DD} + 0.3$      | V     |       |
| Hysteresis   | SDA and SCL Input Buffer Hysteresis                              |   | $0.05 \times V_{DD}$ |                 |                     | V     | 7, 8  |
| $V_{OL}$     | SDA Output Buffer LOW Voltage, Sinking 3mA                       | $V_{DD} = 5V$ , $I_{OL} = 3mA$  | 0                    | 0.02            | 0.4                 | V     |       |
| $C_{PIN}$    | SDA and SCL Pin Capacitance                                      | $T_A = +25^\circ C$ , $f = 1MHz$ ,<br>$V_{DD} = 5V$ , $V_{IN} = 0V$ ,<br>$V_{OUT} = 0V$                                     |                      |                 | 10                  | pF    | 7, 8  |
| $f_{SCL}$    | SCL Frequency  |   |                      |                 | 400                 | kHz   |       |
| $t_{IN}$     | Pulse Width Suppression Time at SDA and SCL Inputs               | Any pulse narrower than the max spec is suppressed.   |                      |                 | 50                  | ns    |       |
| $t_{AA}$     | SCL Falling Edge To SDA Output Data Valid                        | SCL falling edge crossing 30% of $V_{DD}$ , until SDA exits the 30% to 70% of $V_{DD}$ window.                              |                      |                 | 900                 | ns    |       |
| $t_{BUF}$    | Time the Bus must be Free Before the Start of a New Transmission | SDA crossing 70% of $V_{DD}$ during a STOP condition, to SDA crossing 70% of $V_{DD}$ during the following START condition. | 1300                 |                 |                     | ns    |       |
| $t_{LOW}$    | Clock LOW Time   | Measured at the 30% of $V_{DD}$ crossing.   | 1300                 |                 |                     | ns    |       |
| $t_{HIGH}$   | Clock HIGH Time  | Measured at the 70% of $V_{DD}$ crossing.   | 600                  |                 |                     | ns    |       |
| $t_{SU:STA}$ | START Condition Setup Time                                       | SCL rising edge to SDA falling edge. Both crossing 70% of $V_{DD}$ .  | 600                  |                 |                     | ns    |       |
| $t_{HD:STA}$ | START Condition Hold Time  | From SDA falling edge crossing 30% of $V_{DD}$ to SCL falling edge crossing 70% of $V_{DD}$ .                               | 600                  |                 |                     | ns    |       |
| $t_{SU:DAT}$ | Input Data Setup Time  | From SDA exiting the 30% to 70% of $V_{DD}$ window, to SCL rising edge crossing 30% of $V_{DD}$ .                           | 100                  |                 |                     | ns    |       |
| $t_{HD:DAT}$ | Input Data Hold Time   | From SCL falling edge crossing 30% of $V_{DD}$ to SDA entering the 30% to 70% of $V_{DD}$ window.                           | 0                    |                 | 900                 | ns    |       |
| $t_{SU:STO}$ | STOP Condition Setup Time  | From SCL rising edge crossing 70% of $V_{DD}$ , to SDA rising edge crossing 30% of $V_{DD}$ .                               | 600                  |                 |                     | ns    |       |

**I<sup>2</sup>C Interface Specifications** Test Conditions:  $V_{DD} = +2.7$  to  $+5.5V$ ,  $T_A = -40^{\circ}C$  to  $+85^{\circ}C$ , unless otherwise specified. (Continued)

| SYMBOL       | PARAMETER                                 | TEST CONDITIONS   | MIN<br>(Note 9)       | TYP<br>(Note 5) | MAX<br>(Note 9) | UNITS      | NOTES |
|--------------|---|---|-----------------------|-----------------|-----------------|------------|-------|
| $t_{HD:STO}$ | STOP Condition Hold Time                  | From SDA rising edge to SCL falling edge. Both crossing 70% of $V_{DD}$ .   | 600                   |                 |                 | ns         |       |
| $t_{DH}$     | Output Data Hold Time                     | From SCL falling edge crossing 30% of $V_{DD}$ , until SDA enters the 30% to 70% of $V_{DD}$ window.  | 0                     |                 |                 | ns         |       |
| $t_R$        | SDA and SCL Rise Time                     | From 30% to 70% of $V_{DD}$ .   | $20 + 0.1 \times C_b$ |                 | 300             | ns         | 8     |
| $t_F$        | SDA and SCL Fall Time                     | From 70% to 30% of $V_{DD}$ .   | $20 + 0.1 \times C_b$ |                 | 300             | ns         | 8     |
| $C_b$        | Capacitive Loading of SDA or SCL          | Total on-chip and off-chip  | 10                    |                 | 400             | pF         | 8     |
| $R_{PU}$     | SDA and SCL Bus Pull-up Resistor Off-chip | Maximum is determined by $t_R$ and $t_F$ .<br>For $C_b = 400pF$ , max is about $2k\Omega$ - $2.5k\Omega$ .<br>For $C_b = 40pF$ , max is about $15k\Omega$ - $20k\Omega$ . | 1                     |                 |                 | k $\Omega$ | 8     |

## NOTES:

- Temperature Conversion is inactive below  $V_{BAT} = 2.7V$ . Device operation is not guaranteed at  $V_{BAT} < 1.8V$ .
- $\overline{IRQ}/F_{OUT}$  Inactive.
- $V_{DD} > V_{BAT} + V_{BATHYS}$
- Specified at  $+25^{\circ}C$ .
- In order to ensure proper timekeeping, the  $V_{DD}$  SR- specification must be followed.
- Limits should be considered typical and are not production tested.
- These are I<sup>2</sup>C specific parameters and are not tested, however, they are used to set conditions for testing devices to validate specification.
- Parameters with MIN and/or MAX limits are 100% tested at  $+25^{\circ}C$ , unless otherwise specified. Temperature limits established by characterization and are not production tested.
- Specifications are typical and require using a recommended crystal (see "Application Section" on page 24).
- Minimum  $V_{DD}$  and/or  $V_{BAT}$  of 1V to sustain the SRAM. The value is based on characterization and it is not tested.

**SDA vs SCL Timing**

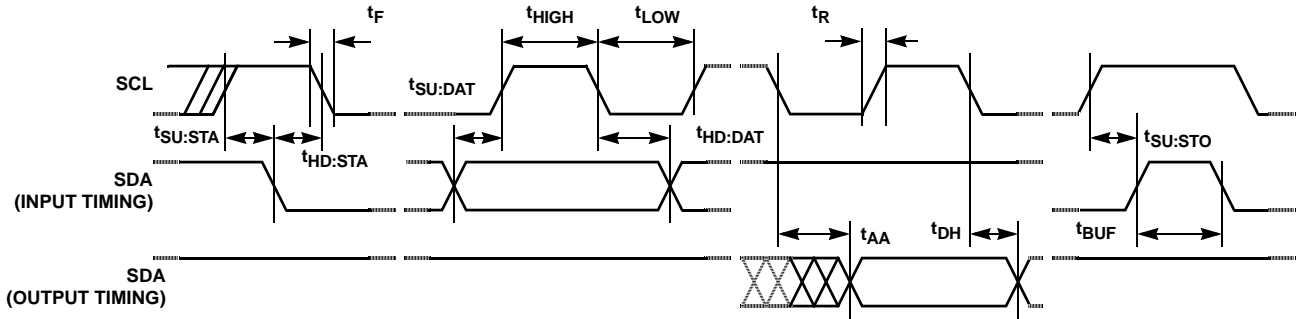

EQUIVALENT AC OUTPUT LOAD CIRCUIT FOR  $V_{DD} = 5V$

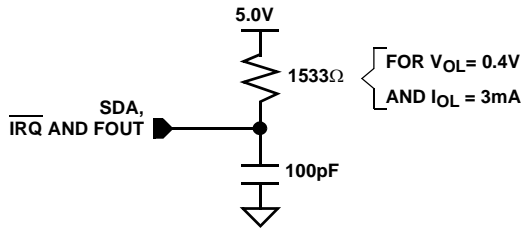

FIGURE 1. STANDARD OUTPUT LOAD FOR TESTING THE DEVICE WITH  $V_{DD} = 5.0V$

**Symbol Table**

| WAVEFORM | INPUTS                      | OUTPUTS                       |
|----------|-----------------------------|-------------------------------|
|          | Must be steady              | Will be steady                |
|          | May change from LOW to HIGH | Will change from LOW to HIGH  |
|          | May change from HIGH to LOW | Will change from HIGH to LOW  |
|          | Don't Care: Changes Allowed | Changing: State Not Known     |
|          | N/A                         | Center Line is High Impedance |

**Typical Performance Curves** Temperature is +25°C unless otherwise specified.

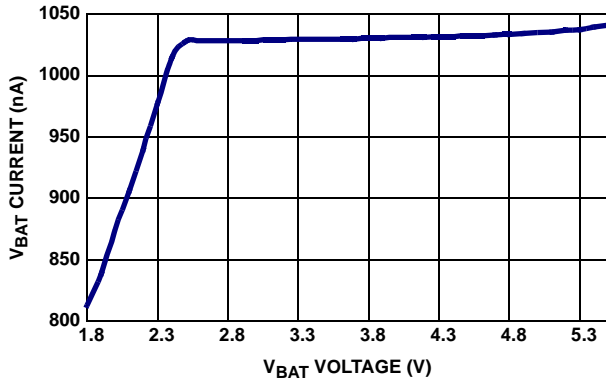

FIGURE 2.  $I_{BAT}$  vs  $V_{BAT}$

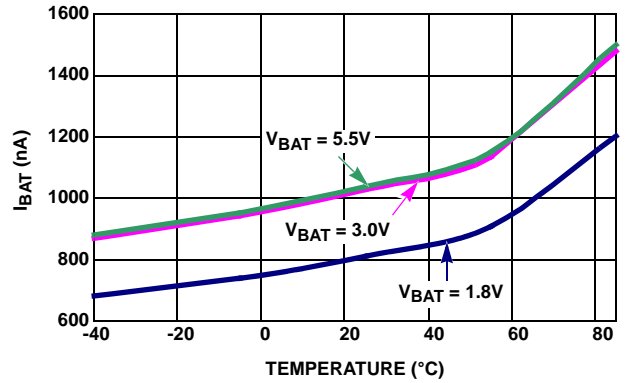

FIGURE 3.  $I_{BAT}$  vs TEMPERATURE

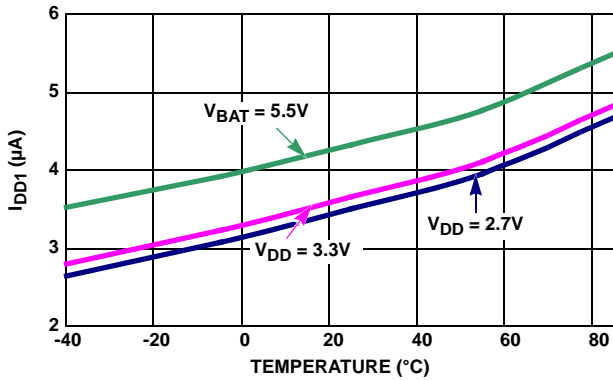

FIGURE 4.  $I_{DD1}$  vs TEMPERATURE

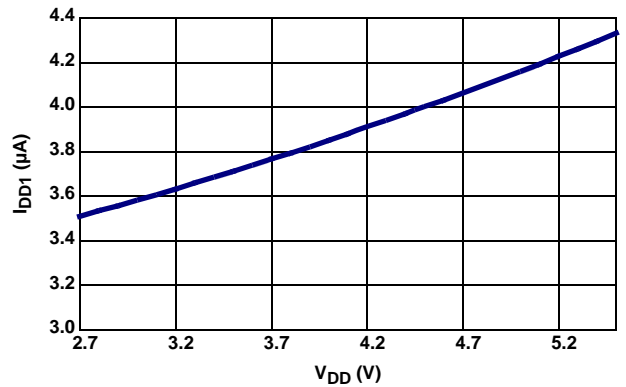

FIGURE 5.  $I_{DD1}$  vs  $V_{DD}$

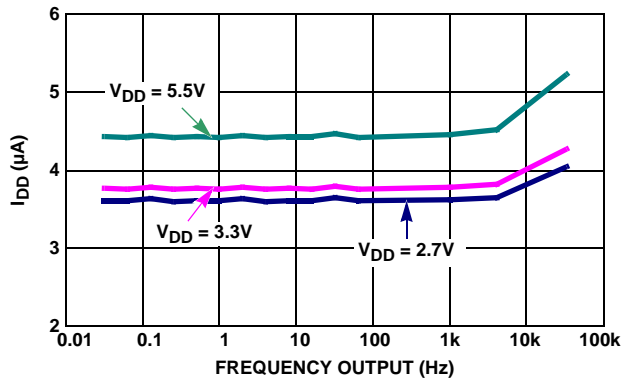

FIGURE 6.  $F_{OUT}$  vs  $I_{DD}$

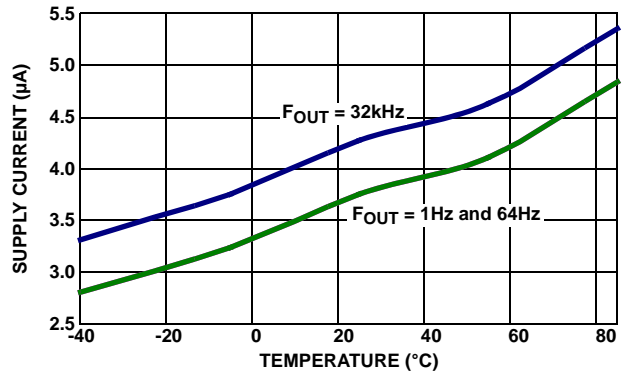

FIGURE 7.  $I_{DD}$  vs TEMPERATURE, 3 DIFFERENT  $F_{OUT}$

## Typical Performance Curves

Temperature is +25°C unless otherwise specified. (Continued)

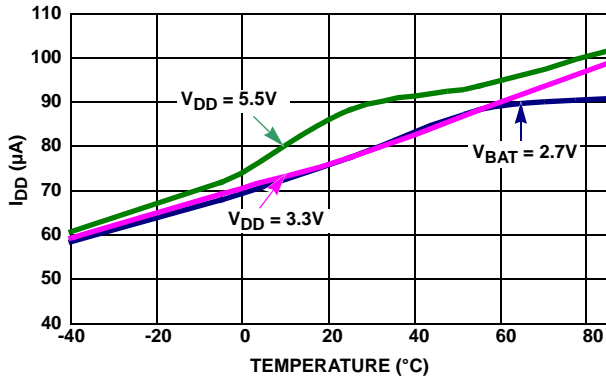

FIGURE 8. I<sub>DD</sub> WITH TSE = 1 vs TEMPERATURE

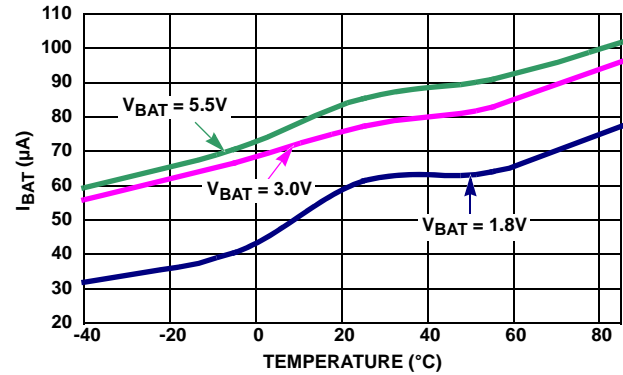

FIGURE 9. I<sub>BAT</sub> with TSE = 1, BTSE = 1 vs TEMPERATURE

### General Description

The ISL12023 device is a low power real time clock (RTC) with embedded temperature sensors. It contains crystal frequency compensation circuitry over the operating temperature range, clock/calendar, power fail and low battery monitors, brownout indicator with separate low voltage reset pin (LVRST), 1 periodic or polled alarm, intelligent battery-backup switching and 128 Bytes of battery-backed user SRAM.

The oscillator uses an external, low cost 32.768kHz crystal. The real time clock tracks time with separate registers for hours, minutes and seconds. The device has calendar registers for date, month, year and day of the week. The calendar is accurate through 2099, with automatic leap year correction. In addition, the ISL12023 could be programmed for automatic Daylight Savings Time (DST) adjustment by entering local DST information.

The ISL12023's alarm can be set to any clock/calendar value for a match. For example, every minute, every Tuesday or at 5:23 a.m. on March 21. The alarm status is available by checking the Status Register, or the device can be configured to provide a hardware interrupt via the IRQ pin. There is a repeat mode for the alarm allowing a periodic interrupt every minute, every hour, every day, etc.

The device also offers a backup power input pin. This V<sub>BAT</sub> pin allows the device to be backed up by battery or super capacitor with automatic switchover from V<sub>DD</sub> to V<sub>BAT</sub>. The ISL12023 device is specified for V<sub>DD</sub> = 2.7V to 5.5V and the clock/calendar portion of the device remains fully operational in battery-backup mode down to 1.8V (Standby Mode). The V<sub>BAT</sub> level is monitored and reported against preselected levels. The first report is registered when the V<sub>BAT</sub> level falls below 85% of nominal level, the second level is set for 75%. Battery levels are stored in PWR\_VBAT registers.

The ISL12023 offers a "Brownout" alarm once the V<sub>DD</sub> falls below a pre-selected trip level. This allows system Micro to save vital information to memory before complete power

loss. There are six V<sub>DD</sub> levels that could be selected for initiation of the Brownout alarm.

### Pin Descriptions

#### X1, X2

The X1 and X2 pins are the input and output, respectively, of an inverting amplifier. An external 32.768kHz quartz crystal is used with the device to supply a timebase for the real time clock. Internal compensation circuitry with internal temperature sensor provides frequency corrections for selected popular crystals to ±5ppm over the operating temperature range from -40°C to +85°C (see "Application Section" on page 24 for recommended crystal). The ISL12023 allows the user to input via I<sup>2</sup>C serial bus the temperature variation profile of an individual crystal. The oscillator compensation network can also be used to calibrate the initial crystal timing accuracy to less than 1ppm error at room temperature. The device can also be driven directly from a 32.768kHz source at pin X1.

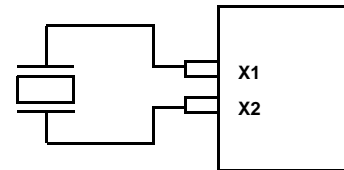

FIGURE 10. RECOMMENDED CRYSTAL CONNECTION

#### V<sub>BAT</sub>

This input provides a backup supply voltage to the device. V<sub>BAT</sub> supplies power to the device in the event that the V<sub>DD</sub> supply fails. The device will automatically switch to the V<sub>BAT</sub> input when V<sub>DD</sub> drops below a prescribed level. See the Battery Monitor parameter in the electrical spec table titled "DC Operating Characteristics-RTC" on page 3. This pin can be connected to a battery, a super capacitor or tied to ground if not used.



**IRQ (Interrupt Output)**

This pin provides an interrupt signal output. This signal notifies a host processor that an alarm has occurred and requests action. It is an open drain active low output. Once triggered, the output will stay low until the Alarm status register bit is reset or, if the auto reset function is used, a read is performed to the status register.

**FOUT (Frequency Output)**

This pin provides a clock signal which is related to the crystal frequency. The output frequency is user selectable and enabled via the I<sup>2</sup>C bus. It is an open drain output.

**Serial Clock (SCL)**

The SCL input is used to clock all serial data into and out of the device. The input buffer on this pin is always active (not gated). It is disabled when the backup power supply on the V<sub>BAT</sub> pin is activated to minimize power consumption.

**Serial Data (SDA)**

SDA is a bi-directional pin used to transfer data into and out of the device. It has an open drain output and may be ORED with other open drain or open collector outputs. The input buffer is always active (not gated) in normal mode.

An open drain output requires the use of a pull-up resistor. The output circuitry controls the fall time of the output signal with the use of a slope controlled pull-down. The circuit is designed for 400kHz I<sup>2</sup>C interface speeds. It is disabled when the backup power supply on the V<sub>BAT</sub> pin is activated.

**V<sub>DD</sub>, GND**

Chip power supply and ground pins. The device will operate with a power supply from V<sub>DD</sub> = 2.7V to 5.5VDC. A 0.1μF capacitor is recommended on the V<sub>DD</sub> pin to ground.

**LVRST (Low Voltage Reset)**

This pin provides an interrupt signal output. This signal notifies a host processor that the V<sub>DD</sub> level has dropped below the pre-programmed level, normally 85% of nominal V<sub>DD</sub>. The brownout trip level is programmable via a control register. It is an open drain active low output.

**Functional Description****Power Control Operation**

The power control circuit accepts a V<sub>DD</sub> and a V<sub>BAT</sub> input. Many types of batteries can be used with Intersil RTC products. For example, 3.0V or 3.6V Lithium batteries are appropriate, and battery sizes are available that can power the ISL12023 for up to 10 years. Another option is to use a super capacitor for applications where V<sub>DD</sub> is interrupted for up to a month. See the "Application Section" on page 24 for more information.

**Normal Mode (V<sub>DD</sub>) to Battery-Backup Mode (V<sub>BAT</sub>)**

To transition from the V<sub>DD</sub> to V<sub>BAT</sub> mode, both of the following conditions must be met:

**Condition 1:**

$$V_{DD} < V_{BAT} - V_{BATHYS}$$

where  $V_{BATHYS} \approx 50\text{mV}$

**Condition 2:**

$$V_{DD} < V_{TRIP}$$

where  $V_{TRIP} \approx 2.2\text{V}$

**Battery-Backup Mode (V<sub>BAT</sub>) to Normal Mode (V<sub>DD</sub>)**

The ISL12023 device will switch from the V<sub>BAT</sub> to V<sub>DD</sub> mode when one of the following conditions occurs:

**Condition 1:**

$$V_{DD} > V_{BAT} + V_{BATHYS}$$

where  $V_{BATHYS} \approx 50\text{mV}$

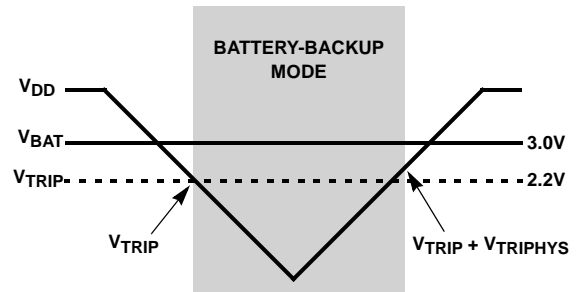
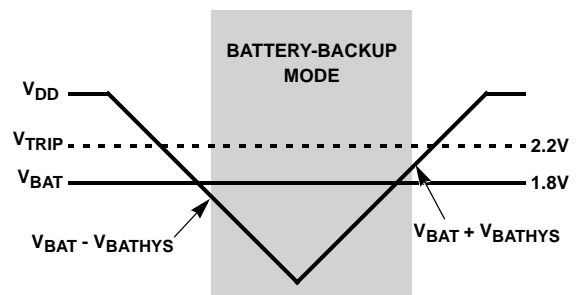
FIGURE 11. BATTERY SWITCHOVER WHEN  $V_{BAT} > V_{TRIP}$ FIGURE 12. BATTERY SWITCHOVER WHEN  $V_{BAT} < V_{TRIP}$ **Condition 2:**

$$V_{DD} > V_{TRIP} + V_{TRIPPHYS}$$

where  $V_{TRIPPHYS} \approx 30\text{mV}$

These power control situations are illustrated in Figures 11 and 12.

The I<sup>2</sup>C bus is deactivated in battery-backup mode to reduce power consumption. Aside from this, all RTC functions are operational during battery-backup mode. Except for SCL and SDA, all the inputs and outputs of the ISL12023 are active during battery-backup mode unless disabled via the control register.

The device Time Stamps the switchover from  $V_{DD}$  to  $V_{BAT}$  and  $V_{BAT}$  to  $V_{DD}$ , and the time is stored in  $t_{SV2B}$  and  $t_{SB2V}$  registers respectively. If multiple  $V_{DD}$  power-down sequences occur before status is read, the earliest  $V_{DD}$  to  $V_{BAT}$  power-down time is stored and the most recent  $V_{BAT}$  to  $V_{DD}$  time is stored.

Temperature conversion and compensation can be enabled in battery-backup mode. Bit BTSE in the BETA register controls this operation, as described in "BETA Register (BETA)" on page 17.

### Power Failure Detection

The ISL12023 provides a Real Time Clock Failure Bit (RTCF) to detect total power failure. It allows users to determine if the device has powered up after having lost all power to the device (both  $V_{DD}$  and  $V_{BAT}$ ).

### Brownout Detection

The ISL12023 monitors the  $V_{DD}$  level continuously and provides warning if the  $V_{DD}$  level drops below prescribed levels. There are six (6) levels that can be selected for the trip level. These values are 85% below popular  $V_{DD}$  levels. The LVDD bit in the Status Register will be set to "1" when brownout is detected. Note that the I<sup>2</sup>C serial bus remains active unless the Battery  $V_{TRIP}$  levels are reached. The  $\overline{LVRST}$  output becomes active (LOW) when the Power Brownout Bit (LVDD) is set.

When the  $V_{DD}$  power is re-established and is above the 85%  $V_{DD} + 50mV$  trip point, the  $\overline{LVRST}$  output is set HIGH. The LVDD bit is reset once it is read by the Micro. Note that the I<sup>2</sup>C serial bus remains active unless the Battery  $V_{TRIP}$  levels are reached.

### Battery Level Monitor

The ISL12023 has a built in warning feature once the backup battery level drops first to 85% and then to 75% of the battery's nominal  $V_{BAT}$  level. When the battery voltage drops to between 85% and 75%, the LBAT85 bit is set in the status register. When the level drops below 75%, both LBAT85 and LBAT75 bits are set in the status register.

The battery level monitor is not functional in battery backup mode. In order to read the monitor bits after powering up  $V_{DD}$ , instigate a battery level measurement by setting the TSE bit to "1" (BETA register), and then read the bits.

There is a Battery Time Stamp Function available. Once the  $V_{DD}$  is low enough to enable switchover to the battery, the RTC time/date are written into the TSV2B register. This information can be read from the TSV2B registers to discover the point in time of the  $V_{DD}$  power-down. If there are multiple power-down cycles before reading these registers, the first values stored in these registers will be retained. These registers will hold the original power-down value until they are cleared by setting CLRTS = 1 to clear the registers.

The normal power switching of the ISL12023 is designed to switch into battery-backup mode only if the  $V_{DD}$  power is lost. This will ensure that the device can accept a wide range of backup voltages from many types of sources while reliably switching into backup mode.

Note that the ISL12023 is not guaranteed to operate with  $V_{BAT} < 1.8V$ . If the battery voltage is expected to drop lower than this minimum, correct operation of the device, especially after a  $V_{DD}$  power down cycle, is not guaranteed.

The minimum  $V_{BAT}$  to insure SRAM is stable is 1.0V. Below that, the SRAM may be corrupted when  $V_{DD}$  power resumes.

### Real Time Clock Operation

The Real Time Clock (RTC) uses an external 32.768kHz quartz crystal to maintain an accurate internal representation of second, minute, hour, day of week, date, month, and year. The RTC also has leap-year correction. The clock also corrects for months having fewer than 31 days and has a bit that controls 24-hour or AM/PM format. When the ISL12023 powers up after the loss of both  $V_{DD}$  and  $V_{BAT}$ , the clock will not begin incrementing until at least one byte is written to the clock register.

### Single Event and Interrupt

The alarm mode is enabled via the MSB bit. Choosing single event or interrupt alarm mode is selected via the IM bit. Note that when the frequency output function is enabled, the alarm function is disabled.

The standard alarm allows for alarms of time, date, day of the week, month, and year. When a time alarm occurs in single event mode, an  $\overline{IRQ}$  pin will be pulled low and the alarm status bit (ALM) will be set to "1".

The pulsed interrupt mode allows for repetitive or recurring alarm functionality. Hence, once the alarm is set, the device will continue to alarm for each occurring match of the alarm and present time. Thus, it will alarm as often as every minute (if only the nth second is set) or as infrequently as once a year (if at least the nth month is set). During pulsed interrupt mode, the  $\overline{IRQ}$  pin will be pulled low for 250ms and the alarm status bit (ALM) will be set to "1".

The ALM bit can be reset by the user or cleared automatically using the auto reset mode (see ARST bit). The alarm function can be enabled/disabled during battery-backup mode using the FOBATB bit. For more information on the alarm, please see "ALARM Registers (10h to 15h)" on page 19.

### Frequency Output Mode

The ISL12023 has the option to provide a clock output signal using the  $F_{OUT}$  open drain output pin. The frequency output mode is set by using the FO bits to select one of 15 possible output frequency values from 1/32Hz to 32kHz. The frequency output can be enabled/disabled during battery-backup mode using the FOBATB bit.

### General Purpose User SRAM

The ISL12023 provides 128 bytes of user SRAM. The SRAM will continue to operate in battery-backup mode. However, it should be noted that the I<sup>2</sup>C bus is disabled in battery-backup mode.

### I<sup>2</sup>C Serial Interface

The ISL12023 has an I<sup>2</sup>C serial bus interface that provides access to the control and status registers and the user SRAM. The I<sup>2</sup>C serial interface is compatible with other industry I<sup>2</sup>C serial bus protocols using a bi-directional data signal (SDA) and a clock signal (SCL).

### Oscillator Compensation

The ISL12023 provides both initial timing correction and temperature correction due to variation of the crystal oscillator. Analog and digital trimming control is provided for initial adjustment, and a temperature compensation function is provided to automatically correct for temperature drift of the crystal. Initial values are preset and recalled on initial power-up for the Initial AT and DT settings (IATR, IDTR), temperature coefficient (ALPHA), crystal capacitance (BETA), and the crystal turnover temperature (XTO). These initial values are typical of units available on the market, although the user may program specific values after testing for best accuracy. The function can be enabled/disabled at any time and can be used in battery mode as well.

### Register Descriptions

The battery-backed registers are accessible following a slave byte of "1101111x" and reads or writes to addresses [00h:2Fh]. The defined addresses and default values are described in the Table 1. The battery backed general purpose SRAM has a different slave address (1010111x), so it is not possible to read/write that section of memory while accessing the registers.

### REGISTER ACCESS

The contents of the registers can be modified by performing a byte or a page write operation directly to any register address.

The registers are divided into 8 sections. They are:

1. Real Time Clock (7 bytes): Address 00h to 06h.
2. Control and Status (13 bytes): Address 07h to 0Fh and 2Ah to 2Dh.
3. Alarm (6 bytes): Address 10h to 15h.
4. Time Stamp for Battery Status (5 bytes): Address 16h to 1Ah.
5. Time Stamp for V<sub>DD</sub> Status (5 bytes): Address 1Bh to 1Fh.
6. Daylight Saving Time (8 bytes): 20h to 27h.
7. Temperature (2 bytes): 28h to 29h
8. Crystal Net PPM Correction, NPPM (2 bytes): 2Ah, 2Bh
9. Crystal Turnover Temperature, XTO (1 byte): 2Ch
10. Crystal ALPHA at high temperature, ALPHA\_H (1 byte): 2Dh
11. Scratch Pad (2 bytes): Address 2Eh and 2Fh

Write capability is allowable into the RTC registers (00h to 06h) only when the WRTC bit (bit 6 of address 08h) is set to "1". A multi-byte read or write operation should be limited to one section per operation for best RTC time keeping performance. When the previous address is 2Fh, the next address will wrap around to 00h.

A register can be read by performing a random read at any address at any time. This returns the contents of that register location. Additional registers are read by performing a sequential read. For the RTC and Alarm registers, the read instruction latches all clock registers into a buffer, so an update of the clock does not change the time being read. At the end of a read, the master supplies a stop condition to end the operation and free the bus. After a read, the address remains at the previous address +1 so the user can execute a current address read and continue reading the next register.

It is not necessary to set the WRTC bit prior to writing into the control and status, alarm, and user SRAM registers.

TABLE 1. REGISTER MEMORY MAP

| ADDR. | SECTION | REG NAME | BIT  |      |      |      |      |      |      |      | RANGE   | DEFAULT |
|-------|---------|----------|------|------|------|------|------|------|------|------|---------|---------|
|       |         |          | 7    | 6    | 5    | 4    | 3    | 2    | 1    | 0    |         |         |
| 00h   | RTC     | SC       | 0    | SC22 | SC21 | SC20 | SC13 | SC12 | SC11 | SC10 | 0 to 59 | 00h     |
| 01h   |         | MN       | 0    | MN22 | MN21 | MN20 | MN13 | MN12 | MN11 | MN10 | 0 to 59 | 00h     |
| 02h   |         | HR       | MIL  | 0    | HR21 | HR20 | HR13 | HR12 | HR11 | HR10 | 0 to 23 | 00h     |
| 03h   |         | DT       | 0    | 0    | DT21 | DT20 | DT13 | DT12 | DT11 | DT10 | 1 to 31 | 01h     |
| 04h   |         | MO       | 0    | 0    | 0    | MO20 | MO13 | MO12 | MO11 | MO10 | 1 to 12 | 01h     |
| 05h   |         | YR       | YR23 | YR22 | YR21 | YR20 | YR13 | YR12 | YR11 | YR10 | 0 to 99 | 00h     |
| 06h   |         | DW       | 0    | 0    | 0    | 0    | 0    | DW2  | DW1  | DW0  | 0 to 6  | 00h     |

TABLE 1. REGISTER MEMORY MAP (Continued)

| ADDR. | SECTION | REG NAME | BIT    |          |           |            |           |                       |                       |                       | RANGE    | DEFAULT  |
|-------|---------|----------|--------|----------|-----------|------------|-----------|-----------------------|-----------------------|-----------------------|----------|----------|
|       |         |          | 7      | 6        | 5         | 4          | 3         | 2                     | 1                     | 0                     |          |          |
| 07h   | CSR     | SR       | BUSY   | OSCF     | DSTADJ    | ALM        | LVDD      | LBAT85                | LBAT75                | RTCF                  | N/A      | 01h      |
| 08h   |         | INT      | ARST   | WRTC     | IM        | FOBATB     | FO3       | FO2                   | FO1                   | FO0                   | N/A      | 01h      |
| 09h   |         | PWR_VDD  | CLRTS  | D        | D         | D          | D         | V <sub>DD</sub> Trip2 | V <sub>DD</sub> Trip1 | V <sub>DD</sub> Trip0 | N/A      | 00h      |
| 0Ah   |         | PWR_VBAT |        | RESEALB  | VB85Tp2   | VB85Tp1    | VB85Tp0   | VB75Tp2               | VB75Tp1               | VB75Tp0               | N/A      | 00h      |
| 0Bh   |         | ITRO     | IDTR01 | IDTR00   | IATR05    | IATR04     | IATR03    | IATR02                | IATR01                | IATR00                | N/A      | 20h      |
| 0Ch   |         | ALPHA    | D      | ALPHA6   | ALPHA5    | ALPHA4     | ALPHA3    | ALPHA2                | ALPHA1                | ALPHA0                | N/A      | 46h      |
| 0Dh   |         | BETA     | TSE    | BTSE     | BTSR      | BETA4      | BETA3     | BETA2                 | BETA1                 | BETA0                 | N/A      | 00h      |
| 0Eh   |         | FATR     | 0      | 0        | FFATR5    | FATR4      | FATR3     | FATR2                 | FATR1                 | FATR0                 | N/A      | 00h      |
| 0Fh   |         | FDTR     | 0      | 0        | 0         | FDTR4      | FDTR3     | FDTR2                 | FDTR1                 | FDTR0                 | N/A      | 00h      |
| 10h   |         | ALARM    | SCA0   | ESCA0    | SCA022    | SCA021     | SCA020    | SCA013                | SCA012                | SCA011                | SCA010   | 00 to 59 |
| 11h   | MNA0    |          | EMNA0  | MNA022   | MNA021    | MNA020     | MNA013    | MNA012                | MNA011                | MNA010                | 00 to 59 | 00h      |
| 12h   | HRA0    |          | EHRA0  | D        | HRA021    | HRA020     | HRA013    | HRA012                | HRA011                | HRA010                | 0 to 23  | 00h      |
| 13h   | DTA0    |          | EDTA0  | D        | DTA021    | DTA020     | DTA013    | DTA012                | DTA011                | DTA010                | 01 to 31 | 00h      |
| 14h   | MOA0    |          | EMOA00 | D        | D         | MOA020     | MOA013    | MOA012                | MOA011                | MOA010                | 01 to 12 | 00h      |
| 15h   | DWA0    |          | EDWA0  | D        | D         | D          | D         | DWA02                 | DWA01                 | DWA00                 | 0 to 6   | 00h      |
| 16h   | TSV2B   | VSC      | 0      | VSC22    | VSC21     | VSC20      | VSC13     | VSC12                 | VSC11                 | VSC10                 | 0 to 59  | 00h      |
| 17h   |         | VMN      | 0      | VMN22    | VMN21     | VMN20      | VMN13     | VMN12                 | VMN11                 | VMN10                 | 0 to 59  | 00h      |
| 18h   |         | VHR      | VMIL   | 0        | VHR21     | VHR20      | VHR13     | VHR12                 | VHR11                 | VHR10                 | 0 to 23  | 00h      |
| 19h   |         | VDT      | 0      | 0        | VDT21     | VDT20      | VDT13     | VDT12                 | VDT11                 | VDT10                 | 1 to 31  | 00h      |
| 1Ah   |         | VMO      | 0      | 0        | 0         | VMO20      | VMO13     | VMO12                 | VMO11                 | VMO10                 | 1 to 12  | 00h      |
| 1Bh   | TSB2V   | BSC      | 0      | BSC22    | BSC21     | BSC20      | BSC13     | BSC12                 | BSC11                 | BSC10                 | 0 to 59  | 00h      |
| 1Ch   |         | BMN      | 0      | BMN22    | BMN21     | BMN20      | BMN13     | BMN12                 | BMN11                 | BMN10                 | 0 to 59  | 00h      |
| 1Dh   |         | BHR      | BMIL   | 0        | BHR21     | BHR20      | BHR13     | BHR12                 | BHR11                 | BHR10                 | 0 to 23  | 00h      |
| 1Eh   |         | BDT      | 0      | 0        | BDT21     | BDT20      | BDT13     | BDT12                 | BDT11                 | BDT10                 | 1 to 31  | 00h      |
| 1Fh   |         | BMO      | 0      | 0        | 0         | BMO20      | BMO13     | BMO12                 | BMO11                 | BMO10                 | 1 to 12  | 00h      |
| 20h   | DSTCR   | DstMoFd  | DSTE   | D        | D         | DstMoFd20  | DstMoFd13 | DstMoFd12             | DstMoFd11             | DstMoFd10             | 1 to 12  | 00h      |
| 21h   |         | DstDwFd  | D      | DstDwFdE | DstWkFd12 | DstWkFd11  | DstWkFd10 | DstDwFd12             | DstDwFd11             | DstDwFd10             | 0 to 6   | 00h      |
| 22h   |         | DstDIFd  | D      | D        | DstDIFd21 | DstDIFd20  | DstDIFd13 | DstDIFd12             | DstDIFd11             | DstDIFd10             | 1 to 31  | 00h      |
| 23h   |         | DstHrFd  | D      | D        | DstHrFd21 | DstHrFd20  | DstHrFd13 | DstHrFd12             | DstHrFd11             | DstHrFd10             | 0 to 23  | 00h      |
| 24h   |         | DstMoRv  | D      | D        | D         | XDstMoRv20 | DstMoRv13 | DstMoR12v             | DstMoRv11             | DstMoRv10             | 01 to 12 | 00h      |
| 25h   |         | DstDwRv  | D      | DstDwRvE | DstWkrv12 | DstWkrv11  | DstWkrv10 | DstDwRv12             | DstDwRv11             | DstDwRv10             | 0 to 6   | 00h      |
| 26h   |         | DstDIRv  | D      | D        | DstDIRv21 | DstDIRv20  | DstDIRv13 | DstDIRv12             | DstDIRv11             | DstDIRv10             | 01 to 31 | 00h      |
| 27h   |         | DstHrRv  | D      | D        | DstHrRv21 | DstHrRv20  | DstHrRv13 | DstHrRv12             | DstHrRv11             | DstHrRv10             | 0 to 23  | 00h      |
| 28h   | TEMP    | TKOL     | TK07   | TK06     | TK05      | TK04       | TK03      | TK02                  | TK01                  | TK00                  | 00 to FF | 00h      |
| 29h   |         | TKOM     | 0      | 0        | 0         | 0          | 0         | 0                     | TK09                  | TK08                  | 00 to 03 | 00h      |
| 2Ah   | NPPM    | NPPML    | NPPM7  | NPPM6    | NPPM5     | NPPM4      | NPPM3     | NPPM2                 | NPPM1                 | NPPM0                 | 00 to FF | 00h      |
| 2Bh   |         | NPPMH    | 0      | 0        | 0         | 0          | 0         | NPPM10                | NPPM9                 | NPPM8                 | 00 to 07 | 00h      |
| 2Ch   | XT0     | XT0      | D      | D        | D         | XT4        | XT3       | XT2                   | XT1                   | XT0                   | 00 to FF | 00h      |
| 2Dh   | ALPHAH  | ALPHAH   | D      | ALP_H6   | ALP_H5    | ALP_H4     | ALP_H3    | ALP_H2                | ALP_H1                | ALP_H0                | 00 to 7F | 46h      |
| 2Eh   | GPM     | GPM1     | GPM17  | GPM16    | GPM15     | GPM14      | GPM13     | GPM12                 | GPM11                 | GPM10                 | 00 to FF | 00h      |
| 2Fh   |         | GPM2     | GPM27  | GPM26    | GPM25     | GPM24      | GPM23     | GPM22                 | GPM21                 | GPM20                 | 00 to FF | 00h      |

## Real Time Clock Registers

### Addresses [00h to 06h]

#### RTC REGISTERS (SC, MN, HR, DT, MO, YR, DW)

These registers depict BCD representations of the time. As such, SC (Seconds) and MN (Minutes) range from 0 to 59, HR (Hour) can either be a 12-hour or 24-hour mode, DT (Date) is 1 to 31, MO (Month) is 1 to 12, YR (Year) is 0 to 99, and DW (Day of the Week) is 0 to 6.

The DW register provides a Day of the Week status and uses three bits DW2 to DW0 to represent the seven days of the week. The counter advances in the cycle 0-1-2-3-4-5-6-0-1-2-... The assignment of a numerical value to a specific day of the week is arbitrary and may be decided by the system software designer. The default value is defined as "0".

#### 24-HOUR TIME

If the MIL bit of the HR register is "1", the RTC uses a 24-hour format. If the MIL bit is "0", the RTC uses a 12-hour format and HR21 bit functions as an AM/PM indicator with a "1" representing PM. The clock defaults to 12-hour format time with HR21 = "0".

#### LEAP YEARS

Leap years add the day February 29 and are defined as those years that are divisible by 4. Years divisible by 100 are not leap years, unless they are also divisible by 400. This means that the year 2000 is a leap year and the year 2100 is not. The ISL12023 does not correct for the leap year in the year 2100.

## Control and Status Registers (CSR)

### Addresses [07h to 0Fh]

The Control and Status Registers consist of the Status Register, Interrupt and Alarm Register, Analog Trimming and Digital Trimming Registers.

#### Status Register (SR)

The Status Register is located in the memory map at address 07h. This is a volatile register that provides either control or status of RTC failure (RTCF), Battery Level Monitor (LBAT85, LBAT75), alarm trigger, Daylight Savings Time, crystal oscillator enable and temperature conversion in progress bit.

TABLE 2. STATUS REGISTER (SR)

| ADDR | 7    | 6    | 5     | 4   | 3    | 2      | 1      | 0    |
|------|------|------|-------|-----|------|--------|--------|------|
| 07h  | BUSY | OSCF | DSTDJ | ALM | LVDD | LBAT85 | LBAT75 | RTCF |

#### BUSY BIT (BUSY)

Busy Bit indicates temperature sensing is in progress. In this mode, Alpha, Beta and ITRO registers are disabled and cannot be accessed.

#### OSCILLATOR FAIL BIT (OSCF)

The Oscillator Fail Bit indicates that the oscillator has stopped.

#### DAYLIGHT SAVING TIME CHANGE BIT (DSTADJ)

DSTADJ is the Daylight Savings Time Adjusted Bit. It indicates the daylight saving time forward adjustment has happened. If a DST Forward event happens, DSTADJ will be set to "1". The DSTADJ bit will stay high when DSTFD event happens, and will be reset to "0" when the DST Reverse event happens.

DSTADJ can be set to "1" for instances where the RTC device is initialized during the DST Forward period. The DSTE bit must be enabled when the RTC time is more than one hour before the DST Forward or DST Reverse event time setting, or the DST event correction will not happen.

DSTADJ is reset to "0" upon power up. It will reset to "0" when the DSTE bit in Register 15h is set to "0" (DST disabled), but no time adjustment will happen.

#### ALARM BIT (ALM)

This bit announces if the alarm matches the real time clock. If there is a match, the respective bit is set to "1". This bit can be manually reset to "0" by the user or automatically reset by enabling the auto-reset bit (see ARST bit). A write to this bit in the SR can only set it to "0", not "1". An alarm bit that is set by an alarm occurring during an SR read operation will remain set after the read operation is complete.

#### LOW V<sub>DD</sub> INDICATOR BIT (LVDD)

This bit indicates when V<sub>DD</sub> has dropped below the pre-selected trip level (Brownout Mode). The trip points for the brownout levels are selected by three bits: VDD Trip2, VDD Trip1 and VDD Trip0 in PWR\_VDD registers. The LVDD detection is only enabled in VDD mode and the detection happens in real time. The LVDD bit is set whenever the V<sub>DD</sub> has dropped below the pre-selected trip level, and self clears whenever the V<sub>DD</sub> is above the pre-selected trip level.

#### LOW BATTERY INDICATOR 85% BIT (LBAT85)

In Normal Mode (V<sub>DD</sub>), this bit indicates when the battery level has dropped below the pre-selected trip levels. The trip points are selected by three bits: VB85Tp2, VB85Tp1 and VB85Tp0 in the PWR\_VBAT registers. The LBAT85 detection happens automatically once every minute when seconds register reaches 59. The detection can also be manually triggered by setting the TSE bit in BETA register to "1". The LBAT85 bit is set when the V<sub>BAT</sub> has dropped below the pre-selected trip level, and will self clear when the V<sub>BAT</sub> is above the pre-selected trip level at the next detection cycle either by manual or automatic trigger.

In Battery Mode (V<sub>BAT</sub>), this bit indicates the device has entered into battery mode by polling once every 10 minutes. The LBAT85 detection happens automatically once when the minute register reaches x9h or x0h minutes.

**Example - When the LBAT85 is Set To “1” In Battery Mode:**

The minute the register changes to 19h when the device is in battery mode, the LBAT85 is set to “1” the next time the device switches back to Normal Mode.

**Example - When the LBAT85 Remains at “0” In Battery Mode:**

If the device enters into battery mode after the minute register reaches 20h and switches back to Normal Mode before the minute register reaches 29h, then the LBAT85 bit will remain at “0” the next time the device switches back to Normal Mode.

**LOW BATTERY INDICATOR 75% BIT (LBAT75)**

In Normal Mode ( $V_{DD}$ ), this bit indicates when the battery level has dropped below the pre-selected trip levels. The trip points are selected by three bits: VB75Tp2, VB75Tp1 and VB75Tp0 in the PWR\_VBAT registers. The LBAT75 detection happens automatically once every minute when seconds register reaches 59. The detection can also be manually triggered by setting the TSE bit in BETA register to “1”. The LBAT75 bit is set when the  $V_{BAT}$  has dropped below the pre-selected trip level, and will self clear when the  $V_{BAT}$  is above the pre-selected trip level at the next detection cycle either by manual or automatic trigger.

In Battery Mode ( $V_{BAT}$ ), this bit indicates the device has entered into battery mode by polling once every 10 minutes. The LBAT85 detection happens automatically once when the minute register reaches x9h or x0h minutes.

**Example - When the LBAT75 is Set to “1” in Battery Mode:**

The minute register changes to 30h when the device is in battery mode, the LBAT75 is set to “1” the next time the device switches back to Normal Mode.

**Example - When the LBAT75 Remains at “0” in Battery Mode:**

If the device enters into battery mode after the minute register reaches 49h and switches back to Normal Mode before minute register reaches 50h, then the LBAT75 bit will remain at “0” the next time the device switches back to Normal Mode.

**REAL TIME CLOCK FAIL BIT (RTCF)**

This bit is set to a “1” after a total power failure. This is a read only bit that is set by hardware (ISL12023 internally) when the device powers up after having lost all power (defined as  $V_{DD} = 0V$  and  $V_{BAT} = 0V$ ). The bit is set regardless of whether  $V_{DD}$  or  $V_{BAT}$  is applied first. The loss of only one of the supplies does not set the RTCF bit to “1”. The first valid write to the RTC section after a complete power failure resets the RTCF bit to “0” (writing one byte is sufficient).

**Interrupt Control Register (INT)****TABLE 3. INTERRUPT CONTROL REGISTER (INT)**

| ADDR | 7    | 6    | 5  | 4      | 3   | 2   | 1   | 0   |
|------|------|------|----|--------|-----|-----|-----|-----|
| 08h  | ARST | WRTC | IM | FOBATB | FO3 | FO2 | FO1 | FO0 |

**AUTOMATIC RESET BIT (ARST)**

This bit enables/disables the automatic reset of the ALM, LVDD, LBAT85, and LBAT75 status bits only. When ARST bit is set to “1”, these status bits are reset to “0” after a valid read of the respective status register (with a valid STOP condition). When the ARST is cleared to “0”, the user must manually reset the ALM, LVDD, LBAT85, and LBAT75 bits.

**WRITE RTC ENABLE BIT (WRTC)**

The WRTC bit enables or disables write capability into the RTC Timing Registers. The factory default setting of this bit is “0”. Upon initialization or power up, the WRTC must be set to “1” to enable the RTC. Upon the completion of a valid write (STOP), the RTC starts counting. The RTC internal 1Hz signal is synchronized to the STOP condition during a valid write cycle.

**INTERRUPT/ALARM MODE BIT (IM)**

This bit enables/disables the interrupt mode of the alarm function. When the IM bit is set to “1”, the alarm will operate in the interrupt mode, where an active low pulse width of 250ms will appear at the  $\overline{IRQ}$  pin when the RTC is triggered by the alarm as defined by the alarm registers (0Ch to 11h). When the IM bit is cleared to “0”, the alarm will operate in standard mode, where the  $\overline{IRQ}$  pin will be set low until the ALM status bit is cleared to “0”.

**TABLE 4.**

| IM BIT | INTERRUPT/ALARM FREQUENCY                    |
|--------|--|
| 0      | Single Time Event Set By Alarm               |
| 1      | Repetitive/Recurring Time Event Set By Alarm |

**FREQUENCY OUTPUT AND INTERRUPT BIT (FOBATB)**

This bit enables/disables the  $F_{OUT}$  and  $\overline{IRQ}$  pins during battery-backup mode (i.e.  $V_{BAT}$  power source active). When the FOBATB is set to “1” the  $F_{OUT}$  and  $\overline{IRQ}$  pins are disabled during battery-backup mode. This means that both the frequency output and alarm output functions are disabled. When the FOBATB is cleared to “0”, the  $F_{OUT}$  and  $\overline{IRQ}$  pins are enabled during battery-backup mode. Note that the open drain  $F_{OUT}$  and  $\overline{IRQ}$  pins will need a pullup to the battery voltage to operate in battery-backup mode.

**FREQUENCY OUT CONTROL BITS (FO<3:0>)**

These bits enable/disable the frequency output function and select the output frequency at the  $F_{OUT}$  pin. See Table 5 for frequency selection.

**TABLE 5. FREQUENCY SELECTION OF  $F_{OUT}$  PIN**

| FREQUENCY, $F_{OUT}$ | UNITS | FO3 | FO2 | FO1 | FO0 |
|----------------------|-------|-----|-----|-----|-----|
| 0                    | Hz    | 0   | 0   | 0   | 0   |
| 32768                | Hz    | 0   | 0   | 0   | 1   |
| 4096                 | Hz    | 0   | 0   | 1   | 0   |

TABLE 5. FREQUENCY SELECTION OF F<sub>OUT</sub> PIN (Continued)

| FREQUENCY,<br>F <sub>OUT</sub> | UNITS | FO3 | FO2 | FO1 | FO0 |
|--------------------------------|-------|-----|-----|-----|-----|
| 1024                           | Hz    | 0   | 0   | 1   | 1   |
| 64                             | Hz    | 0   | 1   | 0   | 0   |
| 32                             | Hz    | 0   | 1   | 0   | 1   |
| 16                             | Hz    | 0   | 1   | 1   | 0   |
| 8                              | Hz    | 0   | 1   | 1   | 1   |
| 4                              | Hz    | 1   | 0   | 0   | 0   |
| 2                              | Hz    | 1   | 0   | 0   | 1   |
| 1                              | Hz    | 1   | 0   | 1   | 0   |
| 1/2                            | Hz    | 1   | 0   | 1   | 1   |
| 1/4                            | Hz    | 1   | 1   | 0   | 0   |
| 1/8                            | Hz    | 1   | 1   | 0   | 1   |
| 1/16                           | Hz    | 1   | 1   | 1   | 0   |
| 1/32                           | Hz    | 1   | 1   | 1   | 1   |

**POWER SUPPLY CONTROL REGISTER (PWR\_VDD)****Clear Time Stamp Bit (CLRSTS)**

| ADDR | 7      | 6 | 5 | 4 | 3 | 2                     | 1                     | 0                     |
|------|--------|---|---|---|---|-----------------------|-----------------------|-----------------------|
| 09h  | CLRSTS | 0 | 0 | 0 | 0 | V <sub>DD</sub> Trip2 | V <sub>DD</sub> Trip1 | V <sub>DD</sub> Trip0 |

This bit clears Time Stamp V<sub>DD</sub> to Battery (TSV2B) and Time Stamp Battery to V<sub>DD</sub> Registers (TSB2V). The default setting is 0 (CLRSTS = 0) and the Enabled setting is 1 (CLRSTS = 1)

**V<sub>DD</sub> Brownout Trip Voltage BITS (V<sub>DD</sub>Trip<2:0>)**

These bits set the 6 trip levels for the V<sub>DD</sub> alarm, indicating that V<sub>DD</sub> has dropped below a preset level. In this event, the LVDD bit in the Status Register is set to "1" and the LVRST pin is asserted LOW. See Table 6.

TABLE 6. VDD TRIP LEVELS

| V <sub>DD</sub> Trip2 | V <sub>DD</sub> Trip1 | V <sub>DD</sub> Trip0 | TRIP VOLTAGE (V) |
|-----------------------|-----------------------|-----------------------|------------------|
| 0                     | 0                     | 0                     | 2.295            |
| 0                     | 0                     | 1                     | 2.550            |
| 0                     | 1                     | 0                     | 2.805            |
| 0                     | 1                     | 1                     | 3.060            |
| 1                     | 0                     | 0                     | 4.250            |
| 1                     | 0                     | 1                     | 4.675            |

**Battery Voltage Trip Voltage Register (PWR\_VBAT)**

This register controls the trip points for the two V<sub>BAT</sub> alarms, with levels set to approximately 85% and 75% of the nominal battery level.

TABLE 7.

| ADDR | 7 | 6       | 5       | 4       | 3       | 2       | 1       | 0       |
|------|---|---------|---------|---------|---------|---------|---------|---------|
| 0Ah  | D | RESEALB | VB85Tp2 | VB85Tp1 | VB85Tp0 | VB75Tp2 | VB75Tp1 | VB75Tp0 |

**RESEAL BIT (RESEALB)**

This is the Reseal bit for actively disconnecting V<sub>BAT</sub> pin from the internal circuitry. Setting this bit allows the device to disconnect the battery and eliminate standby current drain while the device is unused. Once V<sub>DD</sub> is powered up, this bit is reset and the V<sub>BAT</sub> pin is then connected to the internal circuitry.

**BATTERY LEVEL MONITOR TRIP BITS (VB85TP<2:0>)**

Three bits selects the first alarm (85% of Nominal V<sub>BAT</sub>) level for the battery voltage monitor. There are total of 7 levels that could be selected for the first alarm. Any of the of levels could be selected as the first alarm with no reference as to nominal Battery voltage level. See Table 8.

TABLE 8. VB85T ALARM LEVEL

| VB85Tp2 | VB85Tp1 | VB85Tp0 | BATTERY ALARM TRIP LEVEL (V) |
|---------|---------|---------|------------------------------|
| 0       | 0       | 0       | 2.125                        |
| 0       | 0       | 1       | 2.295                        |
| 0       | 1       | 0       | 2.550                        |
| 0       | 1       | 1       | 2.805                        |
| 1       | 0       | 0       | 3.060                        |
| 1       | 0       | 1       | 4.250                        |
| 1       | 1       | 0       | 4.675                        |

**BATTERY LEVEL MONITOR TRIP BITS (VB75TP<2:0>)**

Three bits select the second alarm (75% of Nominal V<sub>BAT</sub>) level for the battery voltage monitor. There are total of 7 levels that could be selected for the second alarm. Any of the of levels could be selected as the second alarm with no reference as to nominal Battery voltage level. See Table 9.

TABLE 9. BATTERY LEVEL MONITOR TRIP BITS (VB75TP&lt;2:0&gt;)

| VB75Tp2 | VB75Tp1 | VB75Tp0 | BATTERY ALARM TRIP LEVEL (V) |
|---------|---------|---------|------------------------------|
| 0       | 0       | 0       | 1.875                        |
| 0       | 0       | 1       | 2.025                        |
| 0       | 1       | 0       | 2.250                        |
| 0       | 1       | 1       | 2.475                        |
| 1       | 0       | 0       | 2.700                        |
| 1       | 0       | 1       | 3.750                        |
| 1       | 1       | 0       | 4.125                        |

**Initial AT and DT Setting Register (ITRO)**

These bits are used to trim the initial error (at room temperature) of the crystal. Both Digital Trimming (DT) and Analog Trimming (AT) methods are available. The digital trimming uses clock pulse skipping and insertion for frequency adjustment. Analog trimming uses load capacitance adjustment to pull the oscillator frequency. A range of +62.5ppm to -61.5ppm is possible with combined digital and analog trimming.

**AGING AND INITIAL TRIM DIGITAL TRIMMING BITS (IDTR0<1:0>)**

These bits allow ±30.5ppm initial trimming range for the crystal frequency. This is meant to be a coarse adjustment if the range needed is outside that of the IATR control. See Table 10. The IDTR0 register should only be changed while the TSE (Temp Sense Enable) bit is “0”.

**TABLE 10. IDTR0 TRIMMING RANGE**

| IDTR01 | IDTR00 | TRIMMING RANGE   |
|--------|--------|------------------|
| 0      | 0      | Default/Disabled |
| 0      | 1      | +30.5ppm         |
| 1      | 0      | 0ppm             |
| 1      | 1      | -30.5ppm         |

**AGING AND INITIAL ANALOG TRIMMING BITS (IATR0<5:0>)**

The analog trimming register allows +32ppm to -31ppm adjustment in 1ppm/bit increments. This enables fine frequency adjustment for trimming initial crystal accuracy error or to correct for aging drift. The IATR0 register should only be changed while the TSE (Temp Sense Enable) bit is “0”.

**TABLE 11. INITIAL AT AND DT SETTING REGISTER**

| ADDR | 7      | 6      | 5      | 4      | 3      | 2      | 1      | 0      |
|------|--------|--------|--------|--------|--------|--------|--------|--------|
| 0Bh  | IDTR01 | IDTR00 | IATR05 | IATR04 | IATR03 | IATR02 | IATR01 | IATR00 |

Note that setting the IATR to the lowest settings (-31ppm) with the default 32kHz output can cause the oscillator frequency to become unstable on power-up. The lowest settings for IATR should be avoided to insure oscillator frequency integrity.

**TABLE 12. IATRO TRIMMING RANGE**

| IATR05 | IATR04 | IATR03 | IATR02 | IATR01 | IATR00 | TRIMMING RANGE |
|--------|--------|--------|--------|--------|--------|----------------|
| 0      | 0      | 0      | 0      | 0      | 0      | +32            |
| 0      | 0      | 0      | 0      | 0      | 1      | +31            |
| 0      | 0      | 0      | 0      | 1      | 0      | +30            |
| 0      | 0      | 0      | 0      | 1      | 1      | +29            |
| 0      | 0      | 0      | 1      | 0      | 0      | +28            |
| 0      | 0      | 0      | 1      | 0      | 1      | +27            |
| 0      | 0      | 0      | 1      | 1      | 0      | +26            |
| 0      | 0      | 0      | 1      | 1      | 1      | +25            |

**TABLE 12. IATRO TRIMMING RANGE (Continued)**

| IATR05 | IATR04 | IATR03 | IATR02 | IATR01 | IATR00 | TRIMMING RANGE |
|--------|--------|--------|--------|--------|--------|----------------|
| 0      | 0      | 1      | 0      | 0      | 0      | +24            |
| 0      | 0      | 1      | 0      | 0      | 1      | +23            |
| 0      | 0      | 1      | 0      | 1      | 0      | +22            |
| 0      | 0      | 1      | 0      | 1      | 1      | +21            |
| 0      | 0      | 1      | 1      | 0      | 0      | +20            |
| 0      | 0      | 1      | 1      | 0      | 1      | +19            |
| 0      | 0      | 1      | 1      | 1      | 0      | +18            |
| 0      | 0      | 1      | 1      | 1      | 1      | +17            |
| 0      | 1      | 0      | 0      | 0      | 0      | +16            |
| 0      | 1      | 0      | 0      | 0      | 1      | +15            |
| 0      | 1      | 0      | 0      | 1      | 0      | +14            |
| 0      | 1      | 0      | 0      | 1      | 1      | +13            |
| 0      | 1      | 0      | 1      | 0      | 0      | +12            |
| 0      | 1      | 0      | 1      | 0      | 1      | +11            |
| 0      | 1      | 0      | 1      | 1      | 0      | +10            |
| 0      | 1      | 0      | 1      | 1      | 1      | +9             |
| 0      | 1      | 1      | 0      | 0      | 0      | +8             |
| 0      | 1      | 1      | 0      | 0      | 1      | +7             |
| 0      | 1      | 1      | 0      | 1      | 0      | +6             |
| 0      | 1      | 1      | 0      | 1      | 1      | +5             |
| 0      | 1      | 1      | 1      | 0      | 0      | +4             |
| 0      | 1      | 1      | 1      | 0      | 1      | +3             |
| 0      | 1      | 1      | 1      | 1      | 0      | +2             |
| 0      | 1      | 1      | 1      | 1      | 1      | +1             |
| 1      | 0      | 0      | 0      | 0      | 0      | 0              |
| 1      | 0      | 0      | 0      | 0      | 1      | -1             |
| 1      | 0      | 0      | 0      | 1      | 0      | -2             |
| 1      | 0      | 0      | 0      | 1      | 1      | -3             |
| 1      | 0      | 0      | 1      | 0      | 0      | -4             |
| 1      | 0      | 0      | 1      | 0      | 1      | -5             |
| 1      | 0      | 0      | 1      | 1      | 0      | -6             |
| 1      | 0      | 0      | 1      | 1      | 1      | -7             |
| 1      | 0      | 1      | 0      | 0      | 0      | -8             |
| 1      | 0      | 1      | 0      | 0      | 1      | -9             |
| 1      | 0      | 1      | 0      | 1      | 0      | -10            |
| 1      | 0      | 1      | 0      | 1      | 1      | -11            |
| 1      | 0      | 1      | 1      | 0      | 0      | -12            |
| 1      | 0      | 1      | 1      | 0      | 1      | -13            |
| 1      | 0      | 1      | 1      | 1      | 0      | -14            |
| 1      | 0      | 1      | 1      | 1      | 1      | -15            |
| 1      | 1      | 0      | 0      | 0      | 0      | -16            |
| 1      | 1      | 0      | 0      | 0      | 1      | -17            |
| 1      | 1      | 0      | 0      | 1      | 0      | -18            |
| 1      | 1      | 0      | 0      | 1      | 1      | -19            |
| 1      | 1      | 0      | 1      | 0      | 0      | -20            |
| 1      | 1      | 0      | 1      | 0      | 1      | -21            |
| 1      | 1      | 0      | 1      | 1      | 0      | -22            |
| 1      | 1      | 0      | 1      | 1      | 1      | -23            |
| 1      | 1      | 1      | 0      | 0      | 0      | -24            |
| 1      | 1      | 1      | 0      | 0      | 1      | -25            |
| 1      | 1      | 1      | 0      | 1      | 0      | -26            |
| 1      | 1      | 1      | 0      | 1      | 1      | -27            |



TABLE 12. IATRO TRIMMING RANGE (Continued)

| IATR05 | IATR04 | IATR03 | IATR02 | IATR01 | IATR00 | TRIMMING RANGE |
|--------|--------|--------|--------|--------|--------|----------------|
| 1      | 1      | 1      | 1      | 0      | 0      | -28            |
| 1      | 1      | 1      | 1      | 0      | 1      | -29            |
| 1      | 1      | 1      | 1      | 1      | 0      | -30            |
| 1      | 1      | 1      | 1      | 1      | 1      | -31            |

**ALPHA Register (ALPHA)**

TABLE 13. ALPHA REGISTER

| ADDR | 7 | 6      | 5      | 4      | 3      | 2      | 1      | 0      |
|------|---|--------|--------|--------|--------|--------|--------|--------|
| 0Ch  | D | ALPHA6 | ALPHA5 | ALPHA4 | ALPHA3 | ALPHA2 | ALPHA1 | ALPHA0 |

The Alpha variable is 8 bits and is defined as the temperature coefficient of Crystal from  $-40^{\circ}\text{C}$  to  $T_0$ , or the Alpha Cold (there is an Alpha Hot register that must be programmed as well). It is normally given in units of  $\text{ppm}/^{\circ}\text{C}^2$ , with a typical value of  $-0.034$ . The ISL12023 device uses a scaled version of the absolute value of this coefficient in order to get an integer value. Therefore,  $\text{Alpha}\langle 7:0 \rangle$  is defined as the  $(|\text{Actual Alpha Value}| \times 2048)$  and converted to binary. For example, a crystal with Alpha of  $-0.034\text{ppm}/^{\circ}\text{C}^2$  is first scaled  $(|2048 \times (-0.034)| = 70\text{d})$  and then converted to a binary number of  $01000110\text{b}$ .

The practical range of Actual Alpha values is from  $-0.020$  to  $-0.060$ .

The ALPHA register should only be changed while the TSE (Temp Sense Enable) bit is "0". Note that both the ALPHA and the ALPHA Hot registers need to be programmed with values for full range temperature compensation.

**BETA Register (BETA)**

TABLE 14.

| ADDR | 7   | 6    | 5    | 4     | 3     | 2     | 1     | 0     |
|------|-----|------|------|-------|-------|-------|-------|-------|
| 0Dh  | TSE | BTSE | BTSR | BETA4 | BETA3 | BETA2 | BETA1 | BETA0 |

**TEMPERATURE SENSOR ENABLED BIT (TSE)**

This bit enables the Temperature Sensing operation, including the temperature sensor, A/D converter and AT/DT register adjustment. The default mode after power-up is disabled ( $\text{TSE} = 0$ ). To enable the operation, TSE should be set to 1 ( $\text{TSE} = 1$ ). When temperature sense is disabled, the initial values for IATR and IDTR registers are used for frequency control.

All changes to the IDTR, IATR, ALPHA and BETA registers must be made with  $\text{TSE} = 0$ . After loading the new values, TSE can be enabled and the new values are used. When TSE is set to 1, the temperature conversion cycle begins and will end when two temperature conversions are completed. The average of the two conversions is in the TEMP registers.

**TEMP SENSOR CONVERSION IN BATTERY MODE BIT (BTSE)**

This bit enables the Temperature Sensing and Correction in battery mode.  $\text{BTSE} = 0$  (default) no conversion, Temp Sensing or Compensation in battery mode.  $\text{BTSE} = 1$  indicates Temp Sensing and Compensation enabled in battery mode. The BTSE is disabled when the battery voltage is lower than  $2.7\text{V}$ . No temperature compensation will take place with  $V_{\text{BAT}} < 2.7\text{V}$ .

**FREQUENCY OF TEMPERATURE SENSING AND CORRECTION BIT (BTSR)**

This bit controls the frequency of Temp Sensing and Correction.  $\text{BTSR} = 0$  default mode is every 10 minutes,  $\text{BTSR} = 1$  is every 1.0 minute. Note that BTSE has to be enabled in both cases. See Table 15.

TABLE 15. FREQUENCY OF TEMPERATURE SENSING AND CORRECTION BIT

| BTSE | BTSR | TC PERIOD IN BATTERY MODE |
|------|------|---------------------------|
| 0    | 0    | OFF                       |
| 0    | 1    | OFF                       |
| 1    | 0    | 10 Minutes                |
| 1    | 1    | 1 Minute                  |

The temperature measurement conversion time is the same for battery mode as for  $V_{\text{DD}}$  mode, approximately 22ms. The battery mode current will increase during this conversion time to typically  $68\mu\text{A}$ . The average increase in battery current is much lower than this due to the small duty cycle of the ON-time versus OFF-time for the conversion.

To figure the average increase in battery current, we take the the change in current times the duty cycle. For the 1 minute temperature period the average current is shown in Equation 1:

$$\Delta I_{\text{BAT}} = \frac{0.022\text{s}}{60\text{s}} \times 68\mu\text{A} = 250\text{nA} \quad (\text{EQ. 1})$$

For the 10 minute temperature period the average current is shown in Equation 2:

$$\Delta I_{\text{BAT}} = \frac{0.022\text{s}}{600\text{s}} \times 68\mu\text{A} = 25\text{nA} \quad (\text{EQ. 2})$$

If the application has a stable temperature environment that doesn't change quickly, the 10 minute option will work well and the backup battery lifetime impact is minimized. If quick temperature variations are expected (multiple cycles of more than  $10^{\circ}$  within an hour), then the 1 minute option should be considered and the slightly higher battery current figured into overall battery life.

**GAIN FACTOR OF AT BIT (BETA<4:0>)**

Beta is specified to take care of the  $C_m$  variations of the crystal. Most crystals specify  $C_m$  around  $2.2\text{fF}$ . For example, if  $C_m > 2.2\text{fF}$ , the actual AT steps may reduce from  $1\text{ppm/step}$  to approximately  $0.80\text{ppm/step}$ . Beta is then used to adjust for this variation and restore the step size to  $1\text{ppm/step}$ .

BETA values are limited in the range from 01000 to 11111 as shown in Table 16. To use Table 16, the device is tested at two AT settings as follows:

BETA VALUES = (AT(max) - AT(min))/63, where:

AT(max) = F<sub>OUT</sub> in ppm (at AT = 00H) and

AT(min) = F<sub>OUT</sub> in ppm (at AT = 3FH).

The BETA VALUES result is indexed in the right hand column and the resulting Beta factor (for the register) is in the same row in the left column.

The value for BETA should only be changed while the TSE (Temp Sense Enable) bit is "0". The procedure for writing the BETA register involves two steps. First, write the new value of BETA with TSE = 0. Then write the same value of BETA with TSE = 1. This will insure the next temp sense cycle will use the new BETA value.

TABLE 16. BETA VALUES

| BETA<4:0> | AT STEP ADJUSTMENT |
|-----------|--------------------|
| 01000     | 0.5000             |
| 00111     | 0.5625             |
| 00110     | 0.6250             |
| 00101     | 0.6875             |
| 00100     | 0.7500             |
| 00011     | 0.8125             |
| 00010     | 0.8750             |
| 00001     | 0.9375             |
| 00000     | 1.0000             |
| 10000     | 1.0625             |
| 10001     | 1.1250             |
| 10010     | 1.1875             |
| 10011     | 1.2500             |
| 10100     | 1.3125             |
| 10101     | 1.3750             |
| 10110     | 1.4375             |
| 10111     | 1.5000             |
| 11000     | 1.5625             |
| 11001     | 1.6250             |
| 11010     | 1.6875             |
| 11011     | 1.7500             |
| 11100     | 1.8125             |
| 11101     | 1.8750             |
| 11110     | 1.9375             |
| 11111     | 2.0000             |

### Final Analog Trimming Register (FATR)

This register shows the final setting of AT after temperature correction. It is read-only, the user cannot overwrite a value to this register. This value is accessible as a means of monitoring the temperature compensation function. See Table 17.

TABLE 17. FINAL ANALOG TRIMMING REGISTER

| ADDR | 7 | 6 | 5     | 4     | 3     | 2     | 1     | 0     |
|------|---|---|-------|-------|-------|-------|-------|-------|
| 0Eh  | 0 | 0 | FATR5 | FATR4 | FATR3 | FATR2 | FATR1 | FATR0 |

### Final Digital Trimming Register (FDTR)

This register shows the final setting of DT after temperature correction. It is read-only; the user cannot overwrite a value to this register. The value is accessible as a means of monitoring the temperature compensation function. The corresponding clock adjustment values are shown in Table 19. The DT setting has both positive and negative settings to adjust for any offset in the crystal.

TABLE 18. FINAL DIGITAL TRIMMING REGISTER

| ADDR | 7 | 6 | 5 | 4     | 3     | 2     | 1     | 0     |
|------|---|---|---|-------|-------|-------|-------|-------|
| 0Fh  | 0 | 0 | 0 | FDTR4 | FDTR3 | FDTR2 | FDTR1 | FDTR0 |

TABLE 19. CLOCK ADJUSTMENT VALUES FOR FINAL DIGITAL TRIMMING REGISTER

| FDTR<2:0> | DECIMAL | ADJUSTMENT (ppm) |
|-----------|---------|------------------|
| 00000     | 0       | 0                |
| 00001     | 1       | 30.5             |
| 00010     | 2       | 61               |
| 00011     | 3       | 91.5             |
| 00100     | 4       | 122              |
| 00101     | 5       | 152.5            |
| 00110     | 6       | 183              |
| 00111     | 7       | 213.5            |
| 01000     | 8       | 244              |
| 01001     | 9       | 274.5            |
| 01010     | 10      | 305              |
| 10000     | 0       | 0                |
| 10001     | -1      | -30.5            |
| 10010     | -2      | -61              |
| 10011     | -3      | -91.5            |
| 10100     | -4      | -122             |
| 10101     | -5      | -152.5           |
| 10110     | -6      | -183             |
| 10111     | -7      | -213.5           |
| 11000     | -8      | -244             |
| 11001     | -9      | -274.5           |
| 11010     | -10     | -305             |

## ALARM Registers (10h to 15h)

The alarm register bytes are set up identical to the RTC register bytes, except that the MSB of each byte functions as an enable bit (enable = "1"). These enable bits specify which alarm registers (seconds, minutes, etc.) are used to make the comparison. Note that there is no alarm byte for year.

The alarm function works as a comparison between the alarm registers and the RTC registers. As the RTC advances, the alarm will be triggered once a match occurs between the alarm registers and the RTC registers. Any one alarm register, multiple registers, or all registers can be enabled for a match.

There are two alarm operation modes: Single Event and periodic Interrupt Mode:

- **Single Event Mode** is enabled by setting the bit 7 on any of the Alarm registers (ESCA0... EDWA0) to "1", the IM bit to "0", and disabling the frequency output. This mode permits a one-time match between the Alarm registers and the RTC registers. Once this match occurs, the ALM bit is set to "1" and the  $\overline{IRQ}$  output will be pulled low and will remain low until the ALM bit is reset. This can be done manually or by using the auto-reset feature.
- **Interrupt Mode** is enabled by setting the bit 7 on any of the Alarm registers (ESCA0... EDWA0) to "1", the IM bit to "1", and disabling the frequency output. The  $\overline{IRQ}$  output will now be pulsed each time an alarm occurs. This means that once the interrupt mode alarm is set, it will continue to alarm for each occurring match of the alarm and present time. This mode is convenient for hourly or daily hardware interrupts in microcontroller applications such as security cameras or utility meter reading.

To clear a single event alarm, the ALM bit in the status register must be set to "0" with a write. Note that if the ARST bit is set to 1 (address 08h, bit 7), the ALM bit will automatically be cleared when the status register is read.

Following are examples of both Single Event and periodic Interrupt Mode alarms.

### Example 1

- Alarm set with single interrupt (IM = "0")
- A single alarm will occur on January 1 at 11:30 a.m.
- Set Alarm registers as follows:

| ALARM REGISTER | BIT |   |   |   |   |   |   |   | HEX | DESCRIPTION                |
|----------------|-----|---|---|---|---|---|---|---|-----|----------------------------|
|                | 7   | 6 | 5 | 4 | 3 | 2 | 1 | 0 |     |                            |
| SCA0           | 0   | 0 | 0 | 0 | 0 | 0 | 0 | 0 | 00h | Seconds disabled           |
| MNA0           | 1   | 0 | 1 | 1 | 0 | 0 | 0 | 0 | B0h | Minutes set to 30, enabled |
| HRA0           | 1   | 0 | 0 | 1 | 0 | 0 | 0 | 1 | 91h | Hours set to 11, enabled   |
| DTA0           | 1   | 0 | 0 | 0 | 0 | 0 | 0 | 1 | 81h | Date set to 1, enabled     |
| MOA0           | 1   | 0 | 0 | 0 | 0 | 0 | 0 | 1 | 81h | Month set to 1, enabled    |
| DWA0           | 0   | 0 | 0 | 0 | 0 | 0 | 0 | 0 | 00h | Day of week disabled       |

After these registers are set, an alarm will be generated when the RTC advances to exactly 11:30 a.m. on January 1 (after seconds changes from 59 to 00) by setting the ALM bit in the status register to "1" and also bringing the  $\overline{IRQ}$  output low.

### Example 2

- Pulsed interrupt once per minute (IM = "1")
- Interrupts at one minute intervals when the seconds register is at 30s.
- Set Alarm registers as follows:

| ALARM REGISTER | BIT |   |   |   |   |   |   |   | HEX | DESCRIPTION                |
|----------------|-----|---|---|---|---|---|---|---|-----|----------------------------|
|                | 7   | 6 | 5 | 4 | 3 | 2 | 1 | 0 |     |                            |
| SCA0           | 1   | 0 | 1 | 1 | 0 | 0 | 0 | 0 | B0h | Seconds set to 30, enabled |
| MNA0           | 0   | 0 | 0 | 0 | 0 | 0 | 0 | 0 | 00h | Minutes disabled           |
| HRA0           | 0   | 0 | 0 | 0 | 0 | 0 | 0 | 0 | 00h | Hours disabled             |
| DTA0           | 0   | 0 | 0 | 0 | 0 | 0 | 0 | 0 | 00h | Date disabled              |
| MOA0           | 0   | 0 | 0 | 0 | 0 | 0 | 0 | 0 | 00h | Month disabled             |
| DWA0           | 0   | 0 | 0 | 0 | 0 | 0 | 0 | 0 | 00h | Day of week disabled       |

Once the registers are set, the following waveform will be seen at  $\overline{IRQ}$ :

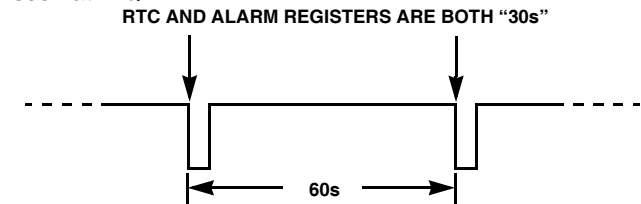

FIGURE 13.  $\overline{IRQ}$  WAVEFORM

Note that the status register ALM bit will be set each time the alarm is triggered, but does not need to be read or cleared.

### Time Stamp $V_{DD}$ to Battery Registers (TSV2B)

The TSV2B Register bytes are identical to the RTC register bytes, except they do not extend beyond the Month. The Time Stamp captures the FIRST  $V_{DD}$  to Battery Voltage transition time, and will not update upon subsequent events, until cleared (only the first event is captured before clearing). Set CLRTS = 1 to clear this register (Add 09h, PWR\_  $V_{DD}$  register).

Note that the time stamp registers are cleared to all "0", including the month and day, which is different from the RTC and alarm registers (those registers default to 01h). This is the indicator that no time stamping has occurred since the last clear or initial power-up. Once a time stamp occurs, there will be a non-zero time stamp.

### Time Stamp Battery to $V_{DD}$ Registers (TSB2V)

The Time Stamp Battery to  $V_{DD}$  Register bytes are identical to the RTC register bytes, except they do not extend beyond Month. The Time Stamp captures the LAST transition of  $V_{BAT}$  to  $V_D$  (only the last event of a series of power-up/down

events is retained). Set CLRTS = 1 to clear this register (add 09h, PWR\_VDD register).

**DST Control Registers (DSTCR)**

8 bytes of control registers have been assigned for the Daylight Savings Time (DST) functions. DST beginning (set Forward) time is controlled by the registers DstMoFd, DstDwFd, DstDtFd, and DstHrFd. DST ending time (set Backward or Reverse) is controlled by DstMoRv, DstDwRv, DstDtRv and DstHrRv.

Tables 20 and 21 describe the structure and functions of the DSTCR.

**DST FORWARD REGISTERS (20H TO 23H)**

DST forward is controlled by the following DST Registers:

**DST Enable**

DSTE is the DST Enabling Bit located in bit 7 of register 20h (DstMoFdxx). Set DSTE = 1 will enable the DSTE function. Upon powering up for the first time (including battery), the DSTE bit defaults to “0”. When DSTE is set to “1” the RTC time must be at least one hour before the scheduled DST time change for the correction to take place. When DSTE is set to “0”, the DSTADJ bit in the Status Register automatically resets to “0”.

**DST Month Forward**

DstMoFd sets the Month that DST starts. The format is the same as for the RTC register month, from 1 to 12. The default value for the DST begin month is 00h.

**DST Day/Week Forward**

DstDwFd contains both the Day of the Week and the Week of the Month data for DST Forward control. DST can be controlled either by actual date or by setting both the Week of the month and the Day of the Week. DstDwFdE sets the priority of the Day/Week over the Date. For DstDwFdE = 1,

Day/Week is the priority. You must have the correct Day of Week entered in the RTC registers for the Day/Week correction to work properly.

- Bits 0, 1, 2 contain the Day of the week information which sets the Day of the Week that DST starts. Note that Day of the week counts from 0 to 6, like the RTC registers. The default for the DST Forward Day of the Week is 00h (normally Sunday).
- Bits 3, 4, 5 contain the Week of the Month information that sets the week that DST starts. The range is from 1 to 5, and Week 7 is used to indicate the last week of the month. The default for the DST Forward Week of the Month is 00h.

**DST Date Forward**

DstDtFd controls which Date DST begins. The format for the Date is the same as for the RTC register, from 1 to 31. The default value for DST forward date is 00h. DstDtFd is only effective if DstDwFdE = 0.

**DST Hour Forward**

DstHrFd controls the hour that DST begins. The RTC hour and DstHrFd registers have the same formats except there is no Military bit for DST hour. The user sets the DST hour with the same format as used for the RTC hour (AM/PM or MIL) but without the MIL bit, and the DST will still advance as if the MIL bit were there. The default value for DST hour Forward is 00h.

**DST REVERSE REGISTERS (24H TO 27H)**

DST end (reverse) is controlled by the following DST Registers:

**DST Month Reverse**

DstMoRv sets the Month that DST ends. The format is the same as for the RTC register month, from 1 to 12. The default value for the DST end month is October (10h).

TABLE 20. DST FORWARD REGISTERS

| ADDRESS | FUNCTION      | 7    | 6     | 5      | 4      | 3      | 2      | 1      | 0      |
|---------|---------------|------|-------|--------|--------|--------|--------|--------|--------|
| 20h     | Month Forward | DSTE | 0     | 0      | MoFd20 | MoFd13 | MoFd12 | MoFd11 | MoFd10 |
| 21h     | Day Forward   | 0    | DwFdE | WkFd12 | WkFd11 | WkFd10 | DwFd12 | DwFd11 | DwFd10 |
| 22h     | Date Forward  | 0    | 0     | DtFd21 | DtFd20 | DtFd13 | DtFd12 | DtFd11 | DtFd10 |
| 23h     | Hour Forward  | 0    | 0     | HrFd21 | HrFd20 | HrFd13 | HrFd12 | HrFd11 | HrFd10 |

TABLE 21. DST REVERSE REGISTERS

| ADDRESS | NAME          | 7 | 6     | 5      | 4      | 3      | 2      | 1      | 0      |
|---------|---------------|---|-------|--------|--------|--------|--------|--------|--------|
| 24h     | Month Reverse | 0 | 0     | 0      | MoRv20 | MoRv13 | MoRv12 | MoRv11 | MoRv10 |
| 25h     | Day Reverse   | 0 | DwRvE | WkRv12 | WkRv11 | WkRv10 | DwRv12 | DwRv11 | DwRv10 |
| 26h     | Date Reverse  | 0 | 0     | DtRv21 | DtRv20 | DtRv13 | DtRv12 | DtRv11 | DtRv10 |
| 27h     | Hour Reverse  | 0 | 0     | HrRv21 | HrRv20 | HrRv13 | HrRv12 | HrRv11 | HrRv10 |

**DST Day/Week Reverse**

DstDwRv contains both the Day of the Week and the Week of the Month data for DST Reverse control. DST can be controlled either by actual date or by setting both the Week of the month and the Day of the Week. DstDwRvE sets the priority of the Day/Week over the Date. For DstDwRvE = 1, Day/Week is the priority. You must have the correct Day of Week entered in the RTC registers for the Day/Week correction to work properly.

- Bits 0, 1, 2 contain the Day of the week information which sets the Day of the Week that DST ends. Note that Day of the week counts from 0 to 6, like the RTC registers. The default for the DST Reverse Day of the Week is 00h (normally Sunday).
- Bits 3, 4, 5 contain the Week of the Month information that sets the week that DST ends. The range is from 1 to 5, and Week 7 is used to indicate the last week of the month. The default for the DST Reverse Week of the Month is 00h.

**DST Date Reverse**

DstDtRv controls which Date DST ends. The format for the Date is the same as for the RTC register, from 1 to 31. The default value for DST Date Reverse is 00h. The DstDtRv is only effective if the DwRvE = 0.

**DST Hour Reverse**

DstHrRv controls the hour that DST ends. The RTC hour and DstHrFd registers have the same formats except there is no Military bit for DST hour. The user sets the DST hour with the same format as used for the RTC hour (AM/PM or MIL) but without the MIL bit, and the DST will still advance as if the MIL bit were there. The default value for DST hour Reverse is 00h

**TEMP Registers (TEMP)**

The temperature sensor produces an analog voltage output which is input to an A/D converter and produces a 10-bit temperature value in degrees Kelvin. TK07:00 are the LSBs of the code, and TK09:08 are the MSBs of the code. The temperature result is actually the average of two successive temperature measurements to produce greater resolution for the temperature control. The output code can be converted to degrees Centigrade (°C) by first converting from binary to decimal, dividing by 2, and then subtracting 273d, as shown in Equation 3.

$$\text{Temperature in } ^\circ\text{C} = [(\text{TK} <9:0>)/2] - 273 \quad (\text{EQ. 3})$$

The practical range for the temp sensor register output is from 446d to 726d, or -50°C to +90°C. The temperature compensation function is only guaranteed over -40°C to +85°C. The TSE bit must be set to "1" to enable temperature sensing.

TABLE 22.

| TEMP | 7    | 6    | 5    | 4    | 3    | 2    | 1    | 0    |
|------|------|------|------|------|------|------|------|------|
| TK0L | TK07 | TK06 | TK05 | TK04 | TK03 | TK02 | TK01 | TK00 |
| TK0M | 0    | 0    | 0    | 0    | 0    | 0    | TK09 | TK08 |

**NPPM Registers (NPPM)**

The NPPM value is exactly 2x the net correction required to bring the oscillator to 0ppm error. The value is the combination of oscillator Initial Correction (IPPM) and crystal temperature dependent correction (CPPM).

IPPM is used to compensate the oscillator offset at room temperature and is controlled by the ITR0 and BETA registers, which are fixed during factor test.

The CPPM compensates the oscillator frequency fluctuation over temperature. It is determined by the temperature (T), crystal curvature parameter (ALPHA), and crystal turnover temperature (XT0). T is the result of the temp sensor/ADC conversion, whose decimal result is 2x the actual temperature in Kelvin. ALPHA is from either the ALPHA (cold) or ALPHAH (hot) register depending on T, and XT0 is from the XT0 register.

NPPM is governed by Equation 4:

$$\begin{aligned} \text{NPPM} &= \text{IPPM}(\text{ITR0}, \text{BETA}) + \text{ALPHA} \times (\text{T} - \text{T0})^2 \\ \text{NPPM} &= \text{IPPM} + \text{CPPM} \\ \text{NPPM} &= \text{IPPM} + \frac{\text{ALPHA} \cdot (\text{T} - \text{T0})^2}{4096} \quad (\text{EQ. 4}) \end{aligned}$$

where:

$$\text{ALPHA} = \alpha \cdot 2048$$

T is the reading of the ADC, result is 2 x temperature in degrees Kelvin.

$$\text{T} = (2 \cdot 298) + \text{XT0} \quad (\text{EQ. 5})$$

$$\text{or } \text{T} = 596 + \text{XT0}$$

Note that NPPM can also be predicted from the FATR and FDTR register by the relationship (all values in decimal):

$$\text{NPPM} = 2 \cdot (\text{BETA} \cdot \text{FATR} - (\text{FDTR} - 16))$$

**XT0 Registers (XT0)****TURNOVER TEMPERATURE (XT<3:0>)**

The apex of the Alpha curve occurs at a point called the turnover temperature, or XT0. Crystals normally have a turnover temperature between +20°C and +30°C, with most occurring near +25°C.

TABLE 23. TURNOVER TEMPERATURE

| ADDR | 7 | 6 | 5 | 4   | 3   | 2   | 1   | 0   |
|------|---|---|---|-----|-----|-----|-----|-----|
| 2Ch  | 0 | 0 | 0 | XT4 | XT3 | XT2 | XT1 | XT0 |

The ISL12023 has a preset turnover temperature corresponding to the crystal in the module. This value is recalled on initial power-up and should never be changed for best temperature compensation performance, although the user may override this preset value if so desired.

Table 24 shows the values available, with a range from +17.5°C to +32.5°C in +0.5°C increments. The default value is 00000b or +25°C.

TABLE 24. XT0 VALUES

| XT<4:0> | TURNOVER TEMPERATURE |
|---------|----------------------|
| 01111   | 32.5                 |
| 01110   | 32.0                 |
| 01101   | 31.5                 |
| 01100   | 31                   |
| 01011   | 30.5                 |
| 01010   | 30                   |
| 01001   | 29.5                 |
| 01000   | 29.0                 |
| 00111   | 28.5                 |
| 00110   | 28.0                 |
| 00101   | 27.5                 |
| 00100   | 27.0                 |
| 00011   | 26.5                 |
| 00010   | 26.0                 |
| 00001   | 25.5                 |
| 00000   | 25.0                 |
| 10000   | 25.0                 |
| 10001   | 24.5                 |
| 10010   | 24.0                 |
| 10011   | 23.5                 |
| 10100   | 23.0                 |
| 10101   | 22.5                 |
| 10110   | 22.0                 |
| 10111   | 21.5                 |
| 11000   | 21.0                 |
| 11001   | 20.5                 |
| 11010   | 20.0                 |
| 11011   | 19.5                 |
| 11100   | 19.0                 |
| 11101   | 18.5                 |
| 11110   | 18.0                 |
| 11111   | 17.5                 |

**ALPHA Hot Register (ALPHAH)**

TABLE 25. ALPHAH REGISTER

| ADDR | 7 | 6      | 5      | 4      | 3      | 2      | 1      | 0      |
|------|---|--------|--------|--------|--------|--------|--------|--------|
| 2Dh  | D | ALP_H6 | ALP_H5 | ALP_H4 | ALP_H3 | ALP_H2 | ALP_H1 | ALP_H0 |

The ALPHA Hot variable is 7 bits and is defined as the temperature coefficient of Crystal from the XT0 value to +85°C (both Alpha Hot and Alpha Cold must be programmed to provide full temperature compensation). It is normally

given in units of ppm/°C<sup>2</sup>, with a typical value of -0.034. Like the ALPHA Cold version, a scaled version of the absolute value of this coefficient is used in order to get an integer value. Therefore, ALP\_H<7:0> is defined as the (|Actual Alpha Hot Value| x 2048) and converted to binary. For example, a crystal with Alpha Hot of -0.034ppm/°C<sup>2</sup> is first scaled (|2048\*(-0.034)| = 70d) and then converted to a binary number of 01000110b.

The practical range of Actual ALPHAH values is from -0.020 to -0.060.

The ISL12023 has a preset ALPHAH value corresponding to the crystal in the module. This value is recalled on initial power-up and should never be changed for best temperature compensation performance, although the user may override this preset value if so desired.

The ALPHAH register should only be changed while the TSE (Temp Sense Enable) bit is "0".

**User Registers (Accessed by Using Slave Address 1010111x)****Addresses [00h to 7Fh]**

These registers are 128 bytes of battery-backed user SRAM. The separate I<sup>2</sup>C slave address must be used to read and write to these registers.

**I<sup>2</sup>C Serial Interface**

The ISL12023 supports a bi-directional bus oriented protocol. The protocol defines any device that sends data onto the bus as a transmitter and the receiving device as the receiver. The device controlling the transfer is the master and the device being controlled is the slave. The master always initiates data transfers and provides the clock for both transmit and receive operations. Therefore, the ISL12023 operates as a slave device in all applications.

All communication over the I<sup>2</sup>C interface is conducted by sending the MSB of each byte of data first.

**Protocol Conventions**

Data states on the SDA line can change only during SCL LOW periods. SDA state changes during SCL HIGH are reserved for indicating START and STOP conditions (see Figure 14). On power-up of the ISL12023, the SDA pin is in the input mode.

All I<sup>2</sup>C interface operations must begin with a START condition, which is a HIGH to LOW transition of SDA while SCL is HIGH. The ISL12023 continuously monitors the SDA and SCL lines for the START condition and does not respond to any command until this condition is met (see Figure 14). A START condition is ignored during the power-up sequence.

All I<sup>2</sup>C interface operations must be terminated by a STOP condition, which is a LOW to HIGH transition of SDA while SCL is HIGH (see Figure 14). A STOP condition at the end

of a read operation or at the end of a write operation to memory only places the device in its standby mode.

An acknowledge (ACK) is a software convention used to indicate a successful data transfer. The transmitting device, either master or slave, releases the SDA bus after transmitting 8 bits. During the ninth clock cycle, the receiver pulls the SDA line LOW to acknowledge the reception of the 8 bits of data (see Figure 15).

The ISL12023 responds with an ACK after recognition of a START condition followed by a valid Identification Byte, and once again after successful receipt of an Address Byte. The ISL12023 also responds with an ACK after receiving a Data Byte of a write operation. The master must respond with an ACK after receiving a Data Byte of a read operation.

### Device Addressing

Following a start condition, the master must output a Slave Address Byte. The 7 MSBs are the device identifier. These bits are "1101111" for the RTC registers and 1010111" for the User SRAM.

The last bit of the Slave Address Byte defines a read or write operation to be performed. When this R/W bit is a "1", then a read operation is selected. A "0" selects a write operation (refer to Figure 17).

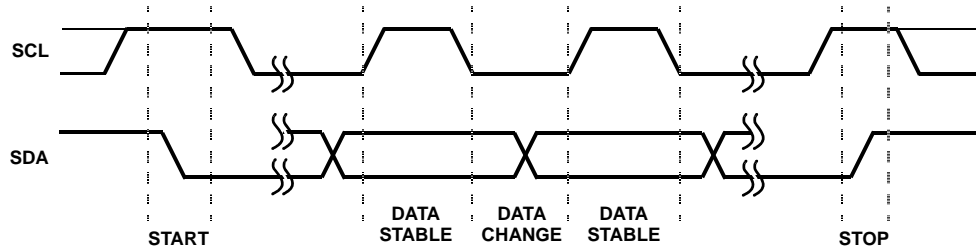

FIGURE 14. VALID DATA CHANGES, START AND STOP CONDITIONS

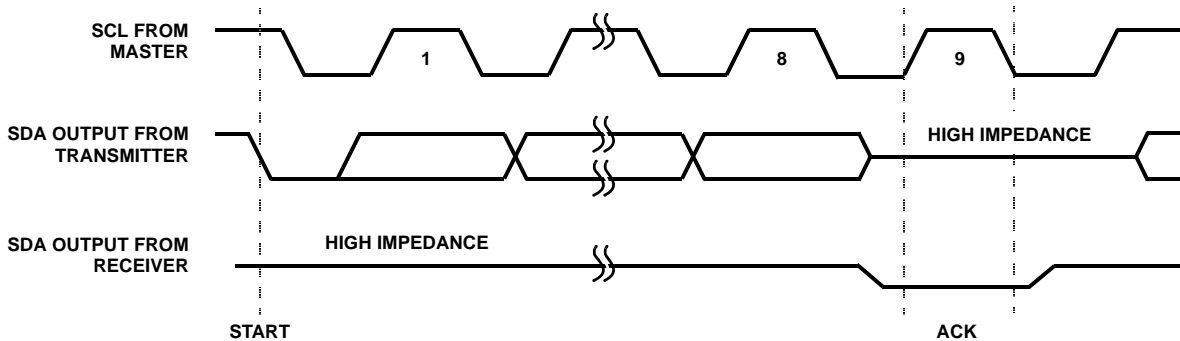

FIGURE 15. ACKNOWLEDGE RESPONSE FROM RECEIVER

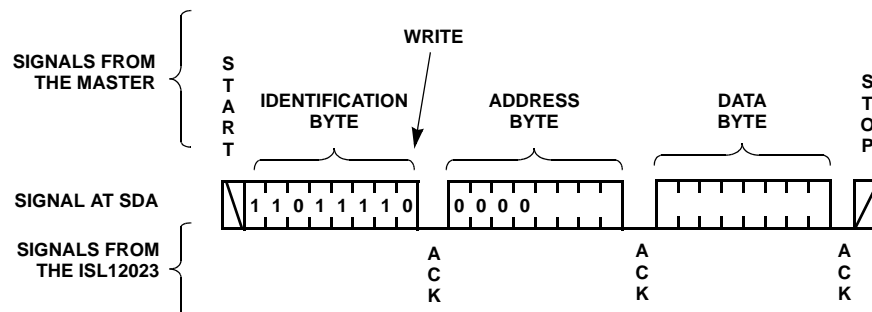
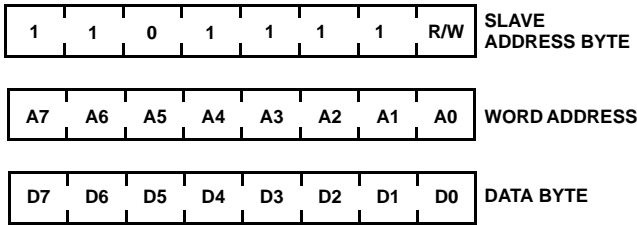

FIGURE 16. BYTE WRITE SEQUENCE (SLAVE ADDRESS FOR CSR SHOWN)



**FIGURE 17. SLAVE ADDRESS, WORD ADDRESS, AND DATA BYTES**

After loading the entire Slave Address Byte from the SDA bus, the ISL12023 compares the device identifier and device select bits with “1101111” or “1010111”. Upon a correct compare, the device outputs an acknowledge on the SDA line.

Following the Slave Byte is a one byte word address. The word address is either supplied by the master device or obtained from an internal counter. On power-up, the internal address counter is set to address 00h, so a current address read starts at address 00h. When required, as part of a random read, the master must supply the 1 Word Address Bytes, as shown in Figure 18.

In a random read operation, the slave byte in the “dummy write” portion must match the slave byte in the “read” section. For a random read of the Control/Status Registers, the slave byte must be “1101111x” in both places.

## Write Operation

A Write operation requires a START condition, followed by a valid Identification Byte, a valid Address Byte, a Data Byte, and a STOP condition. After each of the three bytes, the ISL12023 responds with an ACK. At this time, the I<sup>2</sup>C interface enters a standby state.

## Read Operation

A Read operation consists of a three byte instruction followed by one or more Data Bytes (see Figure 18). The master initiates the operation issuing the following sequence: a START, the Identification byte with the R/W bit set to “0”, an Address Byte, a second START, and a second Identification byte with the R/W bit set to “1”. After each of the three bytes, the ISL12023 responds with an ACK. Then the ISL12023 transmits Data Bytes as long as the master

responds with an ACK during the SCL cycle following the eighth bit of each byte. The master terminates the read operation (issuing a STOP condition) following the last bit of the last Data Byte (see Figure 18).

The Data Bytes are from the memory location indicated by an internal pointer. This pointer's initial value is determined by the Address Byte in the Read operation instruction, and increments by one during transmission of each Data Byte. After reaching the memory location 2Fh, the pointer “rolls over” to 00h, and the device continues to output data for each ACK received.

## Application Section

### Battery-Backup Details

The ISL12023 has automatic switchover to battery-backup when the V<sub>DD</sub> drops below the V<sub>BAT</sub> mode threshold. A wide variety of backup sources can be used, including standard and rechargeable lithium, super capacitors, or regulated secondary sources. The serial interface is disabled in battery-backup, while the oscillator and RTC registers are operational. The SRAM register contents are powered to preserve their contents as well.

The input voltage range for V<sub>BAT</sub> is 1.8V to 5.5V, but keep in mind the temperature compensation only operates for V<sub>BAT</sub> > 2.7V. Note that the device is not guaranteed to operate with a V<sub>BAT</sub> < 1.8V, so the battery should be changed before discharging to that level. It is strongly advised to monitor the low battery indicators in the status registers and take action to replace discharged batteries.

If a supercapacitor is used, it is possible that it may discharge to below 1.8V during prolonged power-down. Once powered up, the device may lose serial bus communications until both V<sub>DD</sub> and V<sub>BAT</sub> are powered down together. To avoid that situation, including situations where a battery may discharge deeply, the circuit in Figure 19 can be used. Some applications will require separate supplies for the RTC V<sub>DD</sub> and the I<sup>2</sup>C pull-ups. This is not advised, as it may compromise the operation of the I<sup>2</sup>C bus. For applications that do require serial bus communication with the RTC V<sub>DD</sub> powered down, the SDA pin must be pulled low during the time the RTC V<sub>DD</sub> ramps down to 0V.

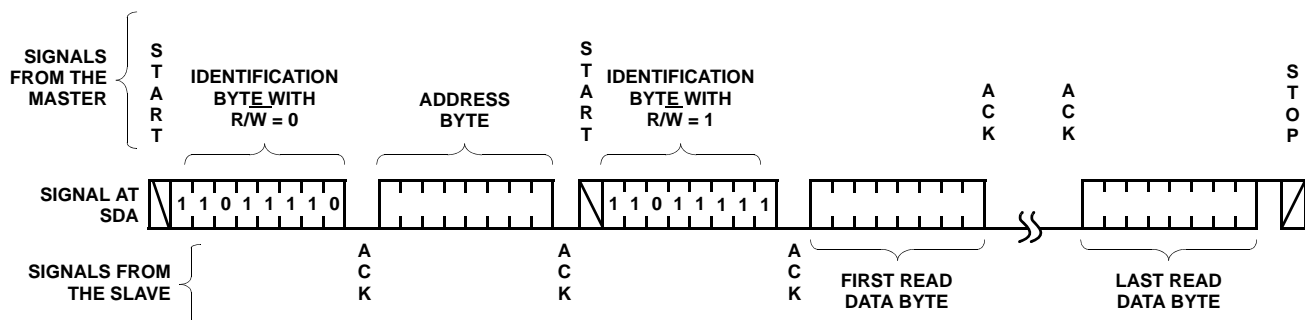

**FIGURE 18. READ SEQUENCE (CSR SLAVE ADDRESS SHOWN)**



Otherwise, the device may lose serial bus communications once V<sub>DD</sub> is powered up, and will return to normal operation ONLY once V<sub>DD</sub> and V<sub>BAT</sub> are both powered down together.

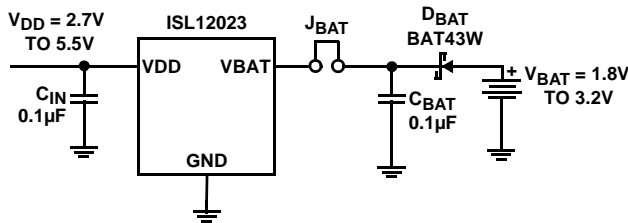

FIGURE 19. SUGGESTED BATTERY-BACKUP CIRCUIT

The diode, D<sub>BAT</sub> will add a small drop to the battery voltage but will protect the circuit should battery voltage drop below 1.8V. The jumper is added as a safeguard should the battery ever need to be disconnect from the circuit.

The V<sub>DD</sub> negative slew rate should be limited to below the data sheet spec (10V/ms) otherwise battery switchover can be delayed, resulting in SRAM contents corruption and oscillator operation interruption.

**Oscillator Crystal Requirements**

The ISL12023 uses a standard 32.768kHz crystal. Either through hole or surface mount crystals can be used. Table 26 lists some recommended surface mount crystals and the parameters of each. This list is not exhaustive and other surface mount devices can be used with the ISL12023 if their specifications are very similar to the devices listed. The crystal should have a required parallel load capacitance of 12.5pF and an equivalent series resistance of less than 50k. The crystal's temperature range specification should match the application. Many crystals are rated for -10°C to +60°C (especially through hole and tuning fork types), so an appropriate crystal should be selected if extended temperature range is required.

TABLE 26. SUGGESTED SURFACE MOUNT CRYSTALS

| MANUFACTURER | PART NUMBER      |
|--------------|------------------|
| Citizen      | CM200S           |
| Epson        | MC-405, MC-406   |
| Raltron      | RSM-200S         |
| SaRonix      | 32S12            |
| Ecliptek     | ECPSM29T-32.768K |
| ECS          | ECX-306          |
| Fox          | FSM-327          |

**Layout Considerations**

The crystal input at X1 has a very high impedance, and oscillator circuits operating at low frequencies such as 32.768kHz, are known to pick up noise very easily if layout precautions are not followed. Most instances of erratic clocking or large accuracy errors can be traced to the susceptibility of the oscillator circuit to interference from adjacent high speed

clock or data lines. Careful layout of the RTC circuit will avoid noise pickup and insure accurate clocking.

Figure 20 shows a suggested layout for the ISL12023 device using a surface mount crystal. Two main precautions should be followed:

1. Do not run the serial bus lines or any high speed logic lines in the vicinity of the crystal. These logic level lines can induce noise in the oscillator circuit to cause misclocking.
2. Add a ground trace around the crystal with one end terminated at the chip ground. This will provide termination for emitted noise in the vicinity of the RTC device..

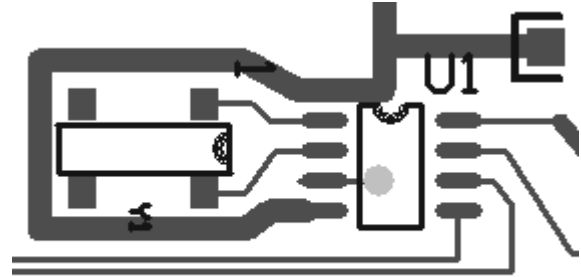

FIGURE 20. SUGGESTED LAYOUT FOR ISL12023 AND CRYSTAL

In addition, it is a good idea to avoid a ground plane under the X1 and X2 pins and the crystal, as this will affect the load capacitance, and therefore, the oscillator accuracy of the circuit. If the F<sub>OUT</sub> pin is used as a clock, it should be routed away from the RTC device as well. The traces for the V<sub>BAT</sub> and V<sub>DD</sub> pins can be treated as a ground, and should be routed around the crystal.

**Crystal Oscillator Frequency Compensation**

**CRYSTAL CHARACTERISTICS**

The ISL12023 device contains a complete system for adjusting the frequency of the crystal oscillator to compensate for temperature variation. A typical 32.768kHz crystal used with RTC devices has a temperature versus frequency curve, as shown in Figure 21.

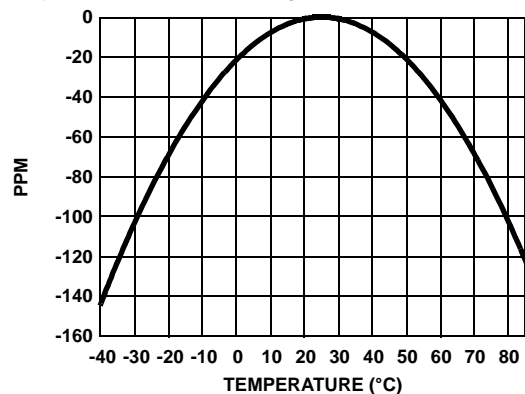

FIGURE 21. RTC CRYSTAL TEMPERATURE DRIFT

This curve equation follows Equation 6:

$$\Delta f = \alpha \bullet (T - T_0)^2 \tag{EQ. 6}$$

Where  $\alpha$  is the temperature constant, with a typical value of 0.034 ppm/°C.

$T_0$  is the turnover temperature of the crystal, which is the apex of the parabolic curve. If the two factors  $\alpha$  and  $T_0$  are known, it is possible to correct for crystal temperature error to very high accuracy.

The crystal will have an initial accuracy error at room temperature, typically specified at  $\pm 20^\circ\text{C}$ . The other important characteristic is the capacitances associated with the crystal. The load capacitance is normally specified at 12.5pF, although it can be lower in some cases. There is also a motional capacitance, which affects the ability of the load capacitance to pull the oscillation frequency, and it is usually in the range of 2.2fF to 4.0fF.

### RTC CLOCK CONTROL

The ISL12023 uses two mechanisms to adjust the RTC clock and correct for the temperature error of the external crystal.

The Analog Trimming (AT) adjusts the load capacitance seen by the crystal. Analog switches connect the appropriate capacitance to change the frequency in increments of 1ppm. The adjustment range for the ISL12023 is +32/-31ppm.

The AT can be further refined using the BETA register. The BETA register function is to allow for changes in  $C_M$  (motional capacitance), which will affect the incremental frequency change of the AT adjustment. A simple test procedure uses the BETA register to bring the step size back to 1ppm.

Normally, the crystal frequency is adjusted at room temperature to zero out the frequency error using the IATRxx register bits (initial Analog Trimming). In addition, the IATRxx setting is varied up and down to record the variation in oscillator frequency compared to the step change in IATRxx. Once that value is known then the BETA register is used to adjust the step size to be as close to 1ppm per IATRxx step as possible. After that adjustment is made, then any ISL12023 temperature compensation adjustments will use a 1ppm change for each bit change in the internal AT adjustment.

The Digital Trimming (DT) uses clock pulse add/subtract logic to change the RTC timing during temperature compensation. The DT steps are much coarser than the AT steps and are therefore used for large adjustments. The DT steps are 30.5ppm, and the range is from -305ppm to +305ppm. The Frequency Output function will show the clock variation with DT settings, except for the 32,768Hz setting, which only shows the AT control.

### ACTIVE TEMPERATURE COMPENSATION

The ISL12023 contains an intelligent logic circuit which takes the temperature sensor digital value as the only input variable. It then uses the register values for the crystal variables  $\alpha$  and  $T_0$ , and combines those with calibration from the BETA and ITR0 registers to produce "Final" values for the AT and DT, known as FATR (Final AT Register) and

FDTR (Final DT Register). Those AT and DT values combine to directly compensate for the temperature error shown in Figure 21.

The temperature sensor produces a new value every 60s (or up to 10 minutes in battery mode), which triggers the logic to calculate a new AT/DT value set. For every temperature calculation result, there can only be one corresponding AT/DT correction value.

### Measuring Oscillator Accuracy

The best way to analyze the ISL12023 frequency accuracy is to set the  $\overline{\text{IRQ}}/\text{F}_{\text{OUT}}$  pin for a specific frequency, and look at the output of that pin on a high accuracy frequency counter (at least 7 digits accuracy). Note that the  $\overline{\text{IRQ}}/\text{F}_{\text{OUT}}$  is a drain output and will require a pull-up resistor.

Using the 1.0Hz output frequency is the most convenient as the ppm error is as expressed in Equation 7:

$$\text{ppm error} = (\text{F}_{\text{OUT}} - 1) \cdot 1\text{e}6 \quad (\text{EQ. 7})$$

Other frequencies may be used for measurement but the error calculation becomes more complex.

When the proper layout guidelines are observed, the oscillator should start-up in most circuits in less than 1s. When testing RTC circuits, a common impulse is to apply a scope probe to the circuit at the X2 pin (oscillator output) and observe the waveform. DO NOT DO THIS! Although in some cases you may see a usable waveform, due to the parasitics (usually 10pF to ground) applied with the scope probe, there will be no useful information in that waveform other than the fact that the circuit is oscillating. The X2 output is sensitive to capacitive impedance so the voltage levels and the frequency will be affected by the parasitic elements in the scope probe. Use the  $\text{F}_{\text{OUT}}$  output and a frequency counter for the most accurate results.

### Temperature Compensation Operation

The ISL12023 temperature compensation feature needs to be enabled by the user. This must be done in a specific order, as follows:

1. Read register 0Dh, the BETA register. This register contains the 5-bit BETA trimmed value which is automatically loaded on initial power-up. Mask off the 5LSB's of the value just read.
2. Bit 7 of the BETA register is the master enable control for temperature sense operation. Set this to "1" to allow continuous temperature frequency correction. Frequency correction will then happen every 60s with  $V_{\text{DD}}$  applied.
3. Bits 5 and 6 of the BETA register control temperature compensation in battery-backup mode (see Table 15). Set the values for the operation desired.
4. Write back to register 0Dh making sure not to change the 5 LSB values, and include the desired compensation control bits.

Note that every time the BETA register is written with the TSE bit = 1, a temperature compensation cycle is instigated

and a new correction value will be loaded into the FATR/FDTR registers (if the temperature changed since the last conversion).

Also note that registers 0Bh and 0Ch, the ITR0 and ALPHA registers, should not be changed. If they must be written be sure to write the same values that are recalled from initial power-up. The ITR0 register may be written if the user wishes to re-calibrate the oscillator frequency at room temperature for aging or board mounting. The original recalled value can be re-written if desired after testing.

For further information on the operation of the ISL12023 and temperature compensated RTC's, see Intersil Application Note AN1389, "Using Intersil's High Accuracy Real Time Clock Module".

<http://www.intersil.com/data/an/AN1389.pdf>

### **Daylight Savings Time (DST) Example**

DST involves setting the forward and back times and allowing the RTC device to automatically advance the time or set the time back. This can be done for current year, and future years. Many regions have DST rules that use standard months, weeks and time of the day which permit a pre-programmed, permanent setting.

Table 27 shows an example setup for the ISL12023.

**TABLE 27. DST EXAMPLE**

| VARIABLE   | VALUE                | REGISTER | VALUE |
|--|----------------------|----------|-------|
| Month Forward and DST Enable                       | April                | 15h      | 84h   |
| Week and Day Forward and select Day/Week, not Date | 1st Week and Sunday  | 16h      | 48h   |
| Date Forward                                       | not used             | 17h      | 00h   |
| Hour Forward                                       | 2am                  | 18h      | 02h   |
| Month Reverse                                      | October              | 19h      | 10h   |
| Week and Day Reverse and select Day/Week, not Date | Last Week and Sunday | 1Ah      | 78h   |
| Date Reverse                                       | not used             | 1Bh      | 00h   |
| Hour Reverse                                       | 2am                  | 1Ch      | 02h   |

The Enable bit (DSTE) is in the Month forward register, so the BCD value for that register is altered with the additional bit. The Week and Day values along with Week/Day vs Date select bit is in the Week/Day register, so that value is also not straight BCD. Hour and Month are normal BCD, but the Hour doesn't use the MIL bit since Military time PM values are already discretely different from AM/PM time PM values. The DST reverse setting utilizes the option to select the last week of the month for October, which could have 4 or 5 weeks but needs to have the time change on the last Sunday.

Note that the DSTADJ bit in the status register monitors

## Thin Shrink Small Outline Plastic Packages (TSSOP)

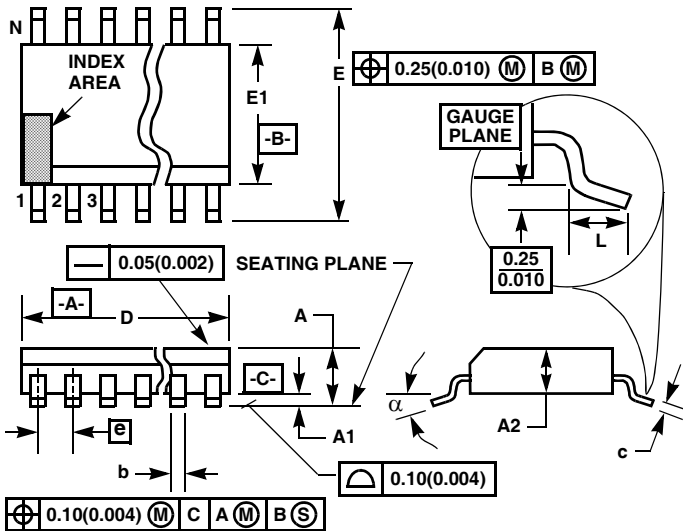

## NOTES:

- These package dimensions are within allowable dimensions of JEDEC MO-153-AC, Issue E.
- Dimensioning and tolerancing per ANSI Y14.5M-1982.
- Dimension "D" does not include mold flash, protrusions or gate burrs. Mold flash, protrusion and gate burrs shall not exceed 0.15mm (0.006 inch) per side.
- Dimension "E1" does not include interlead flash or protrusions. Interlead flash and protrusions shall not exceed 0.15mm (0.006 inch) per side.
- The chamfer on the body is optional. If it is not present, a visual index feature must be located within the crosshatched area.
- "L" is the length of terminal for soldering to a substrate.
- "N" is the number of terminal positions.
- Terminal numbers are shown for reference only.
- Dimension "b" does not include dambar protrusion. Allowable dambar protrusion shall be 0.08mm (0.003 inch) total in excess of "b" dimension at maximum material condition. Minimum space between protrusion and adjacent lead is 0.07mm (0.0027 inch).
- Controlling dimension: MILLIMETER. Converted inch dimensions are not necessarily exact. (Angles in degrees)

## M14.173

## 14 LEAD THIN SHRINK SMALL OUTLINE PLASTIC PACKAGE

| SYMBOL   | INCHES    |        | MILLIMETERS |      | NOTES |
|----------|-----------|--------|-------------|------|-------|
|          | MIN       | MAX    | MIN         | MAX  |       |
| A        | -         | 0.047  | -           | 1.20 | -     |
| A1       | 0.002     | 0.006  | 0.05        | 0.15 | -     |
| A2       | 0.031     | 0.041  | 0.80        | 1.05 | -     |
| b        | 0.0075    | 0.0118 | 0.19        | 0.30 | 9     |
| c        | 0.0035    | 0.0079 | 0.09        | 0.20 | -     |
| D        | 0.195     | 0.199  | 4.95        | 5.05 | 3     |
| E1       | 0.169     | 0.177  | 4.30        | 4.50 | 4     |
| e        | 0.026 BSC |        | 0.65 BSC    |      | -     |
| E        | 0.246     | 0.256  | 6.25        | 6.50 | -     |
| L        | 0.0177    | 0.0295 | 0.45        | 0.75 | 6     |
| N        | 14        |        | 14          |      | 7     |
| $\alpha$ | 0°        | 8°     | 0°          | 8°   | -     |

Rev. 2 4/06

All Intersil U.S. products are manufactured, assembled and tested utilizing ISO9000 quality systems.

Intersil Corporation's quality certifications can be viewed at [www.intersil.com/design/quality](http://www.intersil.com/design/quality)

*Intersil products are sold by description only. Intersil Corporation reserves the right to make changes in circuit design, software and/or specifications at any time without notice. Accordingly, the reader is cautioned to verify that data sheets are current before placing orders. Information furnished by Intersil is believed to be accurate and reliable. However, no responsibility is assumed by Intersil or its subsidiaries for its use; nor for any infringements of patents or other rights of third parties which may result from its use. No license is granted by implication or otherwise under any patent or patent rights of Intersil or its subsidiaries.*

For information regarding Intersil Corporation and its products, see [www.intersil.com](http://www.intersil.com)