



3DD13002S

主要参数 MAIN CHARACTERISTICS

I_C	1.2A
V_{CEO}	400V
$P_C(TO-92)$	1W
$P_C(TO-126(S))$	20W

用途

- 节能灯
- 电子镇流器
- 高频开关电源
- 高频功率变换
- 一般功率放大电路

APPLICATIONS

- Electronic ballasts
- High frequency switching power supply
- High frequency power transform
- Commonly power amplifier circuit

产品特性

- 高耐压
- 高电流容量
- 高开关速度
- 高可靠性
- 环保 (RoHS) 产品

FEATURES

- High breakdown voltage
- High current capability
- High switching speed
- High reliability
- RoHS product

封装 Package

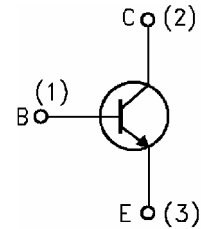

TO-92

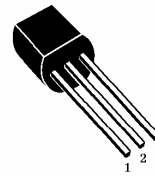

TO-126

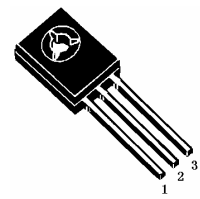

TO-126S

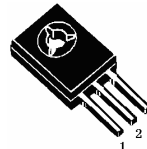

订货信息 ORDER MESSAGE

订货型号 Order codes	印记 Marking	无卤素 Halogen Free	封装 Package	包装 Packaging
3DD13002S-O-T-B-A	13002S	否 NO	TO-92	编带 Brede
3DD13002S-O-T-N-C	13002S	否 NO	TO-92	袋装 Bag
3DD13002S-O-M-N-C	13002S	否 NO	TO-126	袋装 Bag
3DD13002S-O-M-N-B	13002S	否 NO	TO-126	条管 Tube
3DD13002S-O-MS-N-C	13002S	否 NO	TO-126S	袋装 Bag
3DD13002S-O-MS-N-B	13002S	否 NO	TO-126S	条管 Tube





绝对最大额定值 ABSOLUTE RATINGS (Tc=25°C)

项 目 Parameter	符 号 Symbol	数 值 Value	单 位 Unit
集电极—发射极直流电压 Collector-Emitter Voltage (V _{BE} =0)	V _{CES}	600	V
集电极—发射极直流电压 Collector-Emitter Voltage (I _B =0)	V _{CEO}	400	V
发射极—基极直流电压 Emitter-Base Voltage	V _{EBO}	9	V
最大集电极直流电流 Collector Current (DC)	I _C	1.2	A
最大集电极脉冲电流 Collector Current (pulse)	I _{CP}	2.4	A
最大集电极耗散功率 Total Dissipation (TO-92)	P _C	1	W
最大集电极耗散功率 Total Dissipation (TO-126(S))	P _C	20	W
最高结温 Junction Temperature	T _j	150	°C
贮存温度 Storage Temperature	T _{stg}	-55~+150	°C

电特性 ELECTRICAL CHARACTERISTIC

项 目 Parameter	测试条件 Tests conditions	最小值 Value(min)	典型值 Value(typ)	最大值 Value(max)	单 位 Unit
V(BR) _{CEO}	I _C =10mA, I _B =0	400	460	-	V
V(BR) _{CBO}	I _C =1mA, I _B =0	600	800	-	V
V(BR) _{EBO}	I _E =1mA, I _C =0	9	15	-	V
I _{CBO}	V _{CB} =600V, I _E =0	-	-	5	μA
I _{CEO}	V _{CE} =400V, I _B =0	-	-	10	μA
I _{EBO}	V _{EB} =9V, I _C =0	-	-	5	μA
hFE	V _{CE} =10V, I _C =100mA	8	20	40	-
V _{CE(sat)}	I _C =0.5A, I _B =0.1A	-	0.25	0.8	V
V _{BE(sat)}	I _C =0.5A, I _B =0.1A	-	0.9	1.2	V
t _f	V _{CC} =24V I _C =0.25A, I _{B1} =-I _{B2} =0.05A	-	-	0.7	μS
t _s	V _{CC} =24V I _C =0.25A, I _{B1} =-I _{B2} =0.05A	-	-	4	μS
f _T	V _{CE} =10V, I _C =0.1A	4	-	-	MHz

热特性 THERMAL CHARACTERISTIC

项 目 Parameter	符 号 Symbol	最小值 Value(min)	最大值 Value(max)	单 位 Unit
结到环境的热阻 TO-92 Thermal Resistance Junction Case TO-92	R _{th(j-a)}	-	125	°C/W
结到管壳的热阻 TO-126(S) Thermal Resistance Junction Case TO-126(S)	R _{th(j-c)}	-	6.25	°C/W





特征曲线 ELECTRICAL CHARACTERISTICS (curves)

hFE - IC

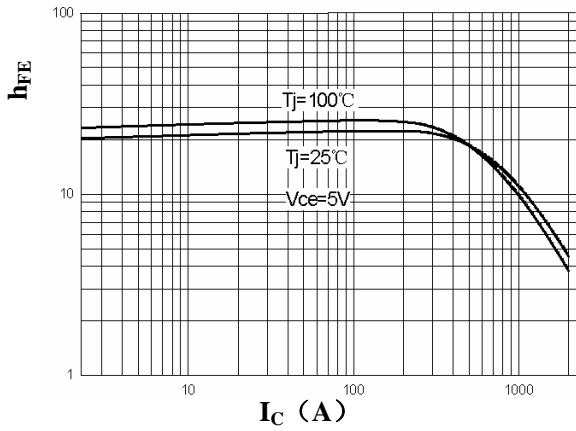

$V_{CE(sat)}$ - I_C

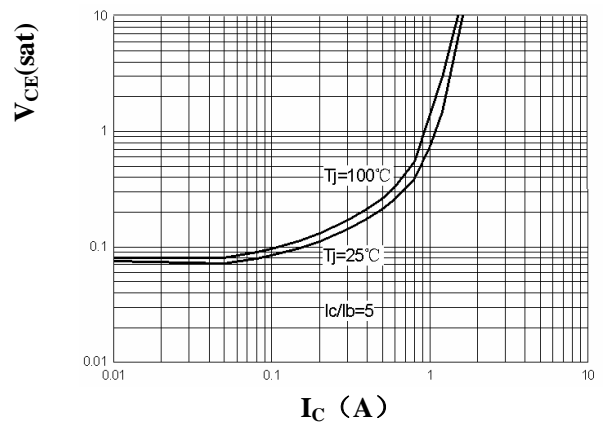

$V_{BE(sat)}$ - I_C

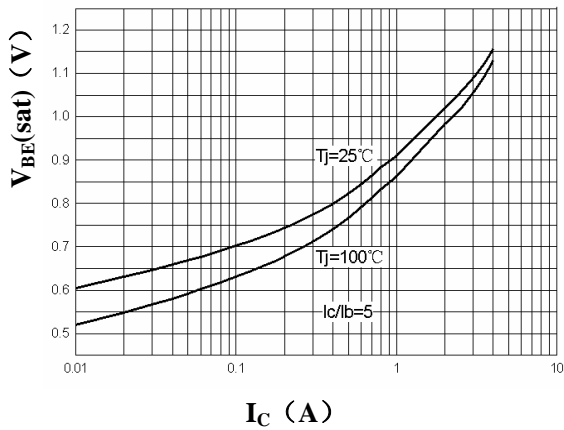

SOA

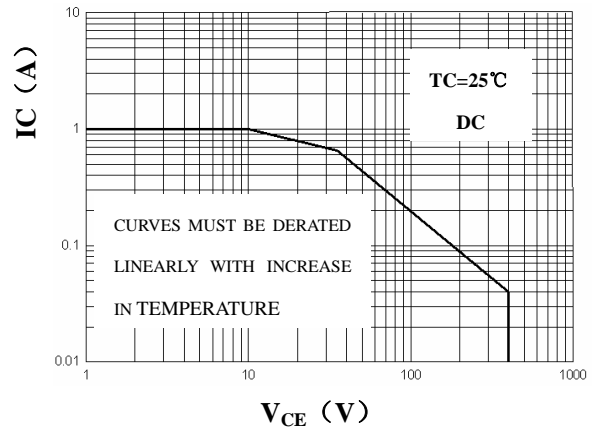

P_C - T_C

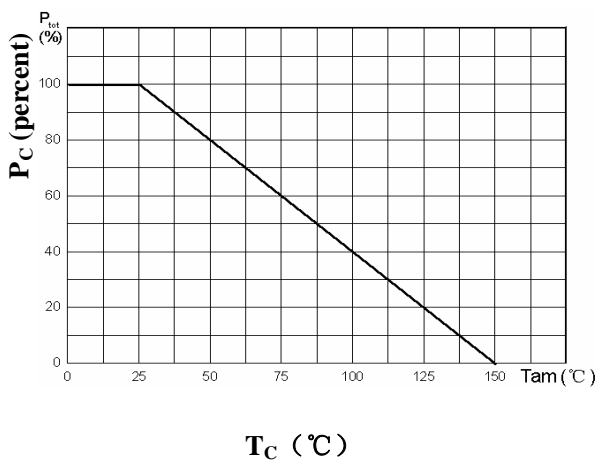



外形尺寸 PACKAGE MECHANICAL DATA
TO-92

单位 Unit : mm

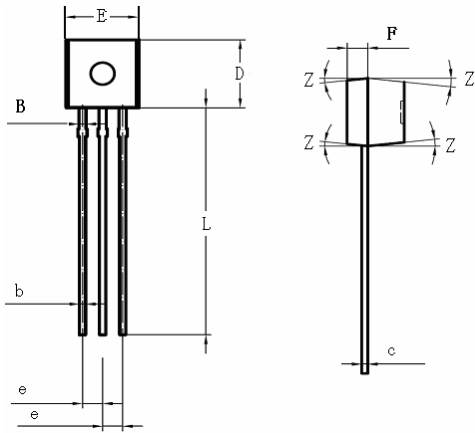

A	3.30-3.90
B	0.35-0.55
b	0.35-0.55
c	0.31-0.51
D	4.30-4.90
E	4.30-4.90
e	1.17-1.37
F	1.00-1.60
L	12.50-15.50
Q	1.00-1.60
Z	2°
Z1	5°

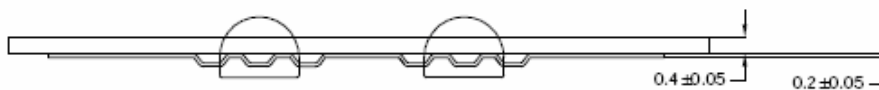
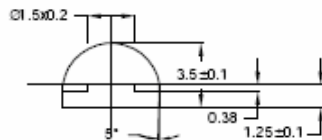
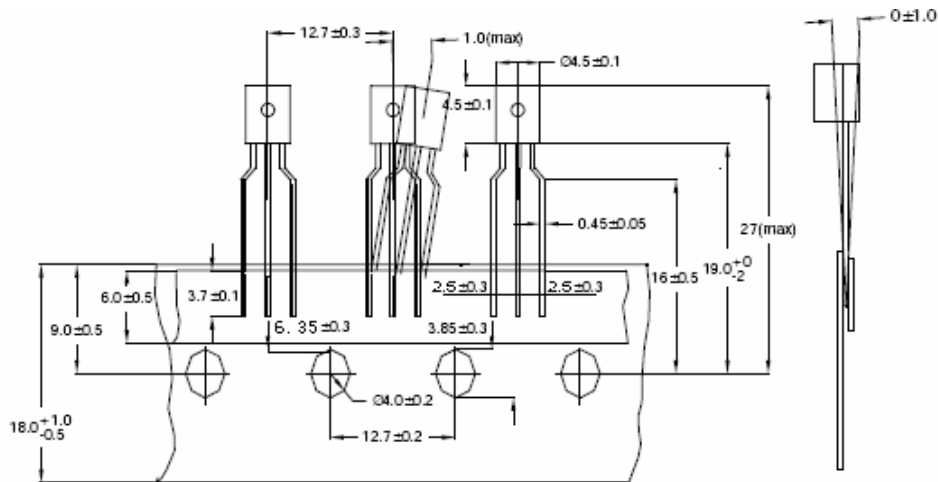
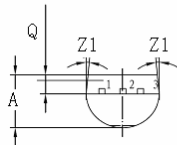



外形尺寸 PACKAGE MECHANICAL DATA
TO-126

单位 Unit : mm

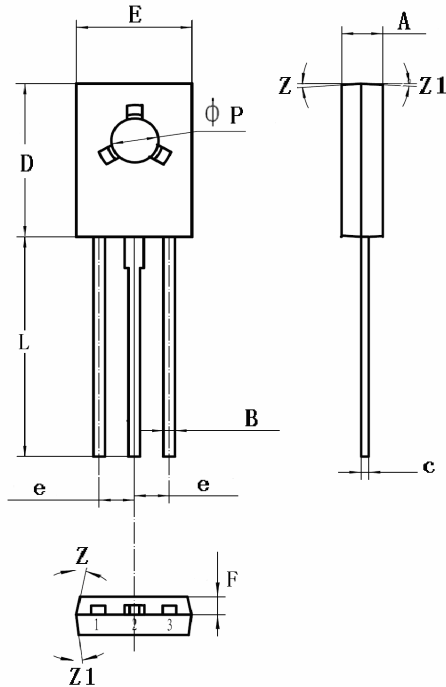

A	2.50-2.90
B	0.60-0.90
c	0.30-0.70
D	10.50-11.10
E	7.10-8.10
e	2.19-2.39
L	14.0-17.0
F	1.07-1.47
Z	4°
Z1	3°
P	2.90-3.30

外形尺寸 PACKAGE MECHANICAL DATA
TO-126S

单位 Unit : mm

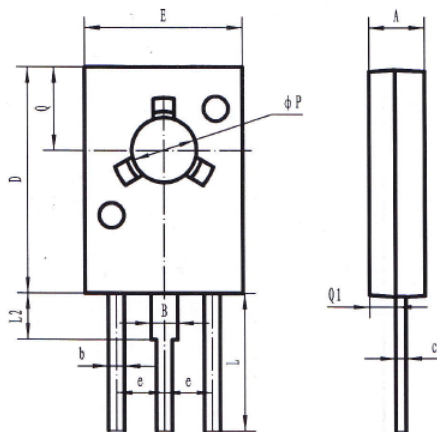

A	2.50-2.90
B	1.22-1.28
c	0.30-0.70
D	10.50-11.10
E	7.10-8.10
Q	3.80-4.20
Q1	1.07-1.47
L	7.80-8.20
L2	2.10-2.30
b	0.60-0.90
e	2.19-2.39



**注意事项**

- 1.吉林华微电子股份有限公司的产品销售分为直销和销售代理，无论哪种方式，订货时请与公司核实。
- 2.购买时请认清公司商标，如有疑问请与公司本部联系。
- 3.在电路设计时请不要超过器件的绝对最大额定值，否则会影响整机的可靠性。
- 4.本说明书如有版本变更不另外告知

NOTE

1. Jilin Sino-microelectronics co., Ltd sales its product either through direct sales or sales agent, thus, for customers, when ordering , please check with our company.
2. We strongly recommend customers check carefully on the trademark when buying our product, if there is any question, please don't be hesitate to contact us.
3. Please do not exceed the absolute maximum ratings of the device when circuit designing.
4. Jilin Sino-microelectronics co., Ltd reserves the right to make changes in this specification sheet and is subject to change without prior notice.

联系方式**吉林华微电子股份有限公司**

公司地址：吉林省吉林市深圳街 99 号

邮编：132013

总机：86-432-64678411

传真：86-432-64665812

网址：www.hwdz.com.cn**市场营销部**

地址：吉林省吉林市深圳街 99 号

邮编：132013

电话：86-432-64675588

64675688

64678411-3098/3099

传真：86-432-64671533

CONTACT**JILIN SINO-MICROELECTRONICS CO., LTD.**

ADD: No.99 Shenzhen Street, Jilin City, Jilin Province, China.

Post Code: 132013

Tel: 86-432-64678411

Fax: 86-432-64665812

Web Site: www.hwdz.com.cn**MARKET DEPARTMENT**

ADD: No.99 Shenzhen Street, Jilin City, Jilin Province, China.

Post Code: 132013

Tel: 86-432-64675588

64675688

64678411-3098/3099

Fax: 86-432-64671533

附录（Appendix）：修订记录（Revision History）

日期 Date	旧版本 Last Rev.	新版本 New Rev.	修订内容 Description of Changes
2009-6-2	200902C	200906D	版式
2009-7-30	200906D	200907E	增加 TO-126S 封装
2009-10-29	200907E	200910F	电话号码、订货代码

