

# NCE25G120T

## NCE25G120T

1200V, 25A, Trench NPT IGBT

### Features

- Trench NPT( Non Punch Through) IGBT
- High speed switching
- Low saturation voltage:  $V_{CE(sat)}=2.0V@I_C=25A$
- High input impedance

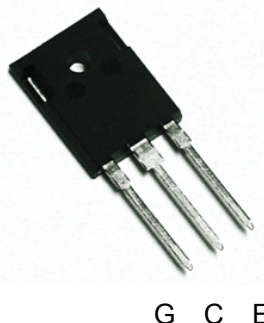

### Applications

- Inductive heating, Microwave oven, Inverter, UPS, etc.
- Soft switching applications

### General Description

Using advanced Trench NPT technology, NCE's 1200V IGBTs offers superior conduction and switching performances, and easy parallel operation with exceptional avalanche ruggedness. This device is designed for soft switching applications.

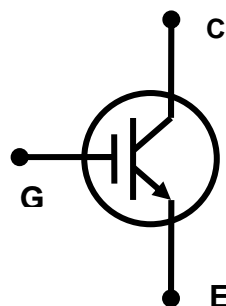

## Absolute Maximum Ratings

Symbol	Description	Ratings	Units
$V_{CES}$	Collector to Emitter Voltage	1200	V
$V_{GES}$	Gate to Emitter Voltage	+/-25	V
$I_C$	Continuous Collector Current @ $T_C=25^{\circ}C$	50	A
	Continuous Collector Current @ $T_C=100^{\circ}C$	25	A
$I_{CM(1)}$	Pulsed Collector Current	90	A
$P_D$	Maximum Power Dissipation @ $T_C=25^{\circ}C$	312	W
	Maximum Power Dissipation @ $T_C=100^{\circ}C$	125	W
$T_J$	Operating Junction Temperature	-55 to +150	$^{\circ}C$
$T_{stg}$	Storage Temperature Range	-55 to +150	$^{\circ}C$
$T_L$	Maximum Lead Temp. for soldering Purposes, 1/8" from case for 5seconds	300	$^{\circ}C$

**Notes:**

1. Repetitive rating, Pulse width limited by max. junction temperature

# NCE25G120T

## Thermal Characteristics

Symbol	Parameter	Typ.	Max.	Units
$R_{\theta JC}$	Thermal Resistance, Junction to Case	-	0.4	$^{\circ}C/W$
$R_{\theta JA}$	Thermal Resistance, Junction to Ambient	-	40	$^{\circ}C/W$

## Electrical Characteristics of the IGBT $T_C=25^{\circ}C$

Symbol	Parameter	Test Conditions	Min.	Typ.	Max.	Units
<b>Off Characteristics</b>						
$BV_{CES}$	Collector to Emitter Breakdown Voltage	$V_{GE}=0V, I_C=1mA$	1200	-	-	V
$I_{CES}$	Collector Cut-Off Current	$V_{CE}=1200V, V_{GE}=0V$	-	-	1	mA
$I_{GES}$	G-E Leakage Current	$V_{GE}=25V, V_{CE}=0V$	-	-	+/-250	nA
<b>On Characteristics</b>						
$V_{GE(th)}$	G-E Threshold Voltage	$I_C=25mA, V_{CE}=V_{GE}$	4.0	-	7.0	V
$V_{CE(sat)}$	Collector to Emitter Saturation Voltage	$I_C=25A, V_{GE}=15V$ $T_C=25^{\circ}C$	-	2	2.5	V
		$I_C=25A, V_{GE}=15V$ $T_C=125^{\circ}C$	-	2.15	-	V
<b>Dynamic Characteristics</b>						
$C_{ies}$	Input Capacitance	$V_{CE}=30V, V_{GE}=0V,$ $f=1MHz$	-	3700	-	pF
$C_{oes}$	Output Capacitance		-	130	-	pF
$C_{res}$	Reverse Transfer Capacitance		-	80	-	pF
<b>Switching Characteristics</b>						
$t_{d(on)}$	Turn-On Delay Time	$V_{CC}=600V, I_C=25A,$ $R_G=10\Omega, V_{GE}=15V,$ Resistive Load, $T_C=25^{\circ}C$	-	50	-	ns
$t_r$	Rise Time		-	60	90	ns
$t_{d(off)}$	Turn-Off Delay Time		-	190	-	ns
$t_f$	Fall Time		-	100	180	ns
$E_{on}$	Turn-On Switching Loss		-	4.1	6.2	mJ
$E_{off}$	Turn-Off Switching Loss		-	0.96	1.5	mJ
$E_{ts}$	Total Switching Loss		-	5.06	7.7	mJ
$t_{d(on)}$	Turn-On Delay Time	$V_{CC}=600V, I_C=25A,$ $R_G=10\Omega, V_{GE}=15V,$ Resistive Load, $T_C=125^{\circ}C$	-	50	-	ns
$t_r$	Rise Time		-	60	-	ns
$t_{d(off)}$	Turn-Off Delay Time		-	200	-	ns
$t_f$	Fall Time		-	154	-	ns
$E_{on}$	Turn-On Switching Loss		-	4.3	6.9	mJ
$E_{off}$	Turn-Off Switching Loss		-	1.5	2.4	mJ
$E_{ts}$	Total Switching Loss		-	5.8	9.3	mJ
$Q_g$	Total Gate Charge	$V_{CC}=600V, I_C=25A,$ $V_{GE}=15V$	-	200	300	nC
$Q_{ge}$	Gate to Emitter Charge		-	15	23	nC
$Q_{gc}$	Gate to Collector Charge		-	100	150	nC

## Typical Performance Characteristics

Figure 1. Typical Output Characteristics

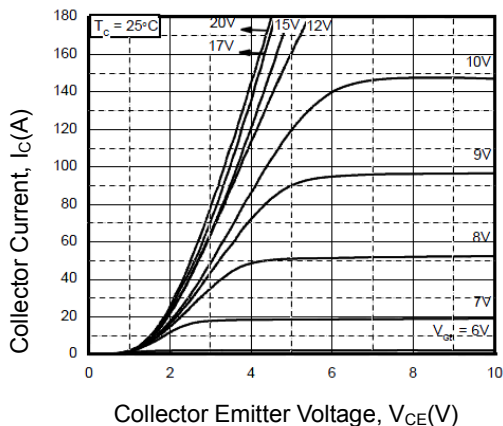

Figure 2. Typical Saturation Voltage Characteristics

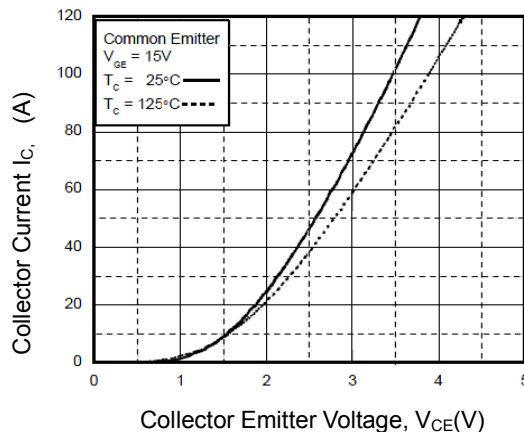

Figure 3. Saturation Voltage vs. Case Temperature at Variant Current Level

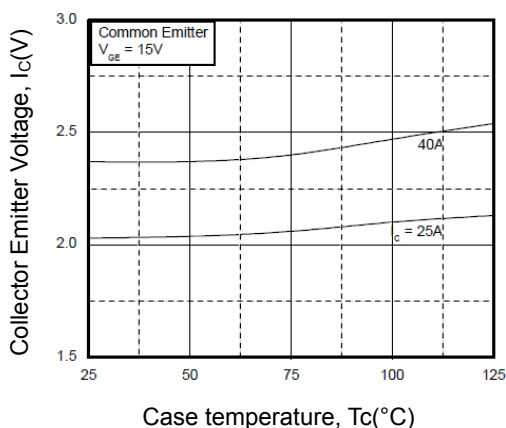

Figure 4. Saturation Voltage vs. Vge

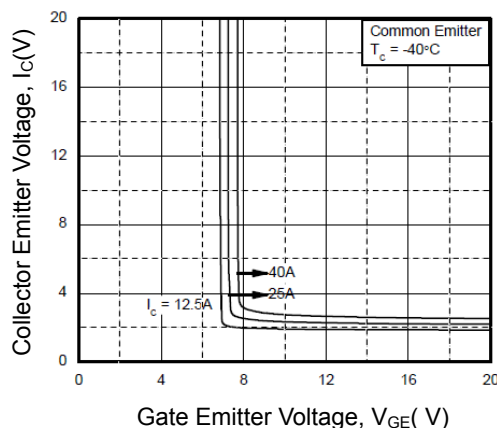

Figure 5. Saturation Voltage vs. Vge

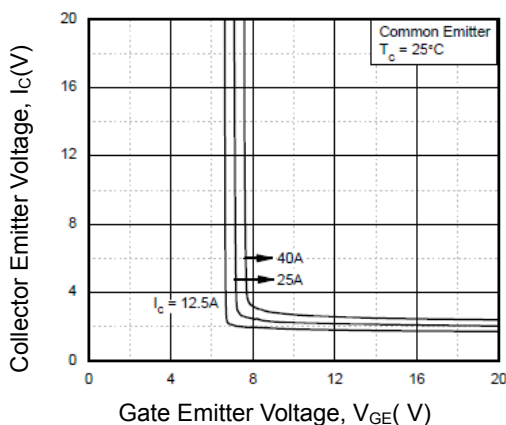
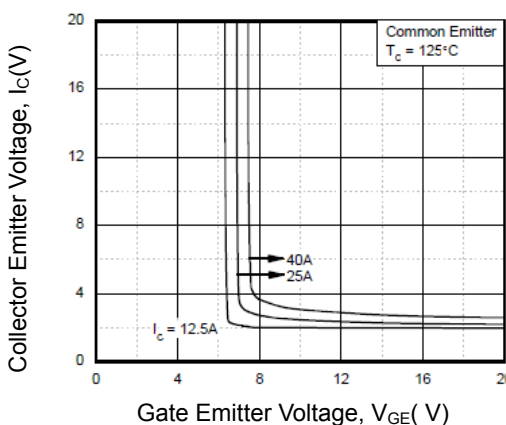

Figure 6. Saturation Voltage vs. Vge



## Typical Performance Characteristics (Continued)

Figure 7. Capacitance Characteristics

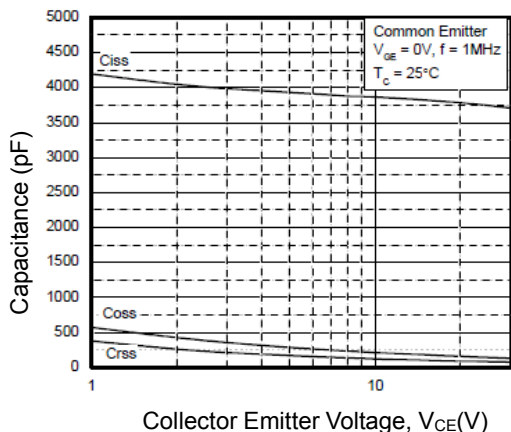

Figure 8. Turn-on Characteristics vs. Gate Resistance

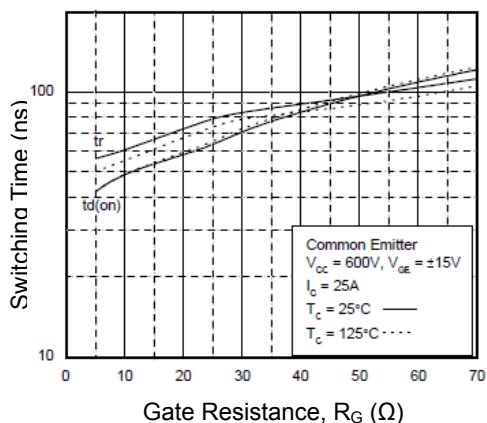

Figure 9. Turn-off Characteristics vs. Gate Resistance

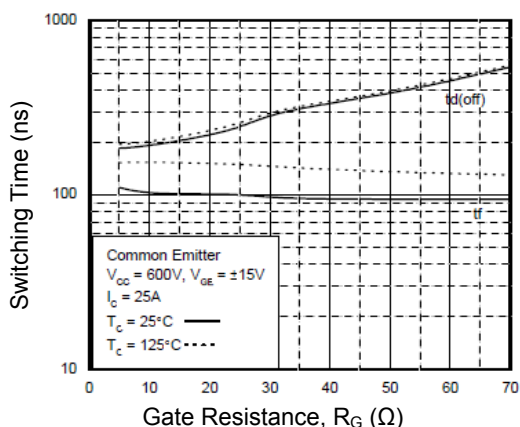

Figure 10. Switching Loss vs. Gate Resistance

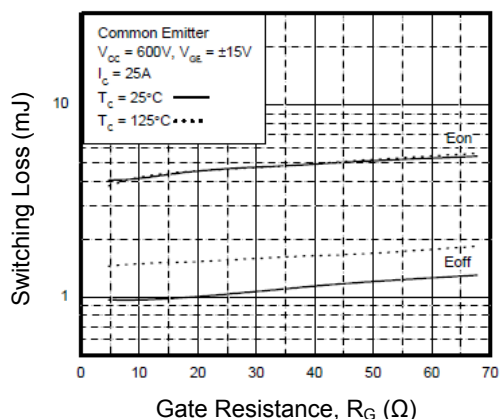

Figure 11. Turn-on Characteristics vs. Collector Current

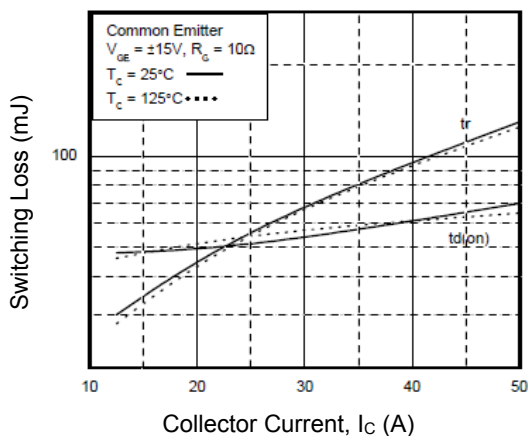
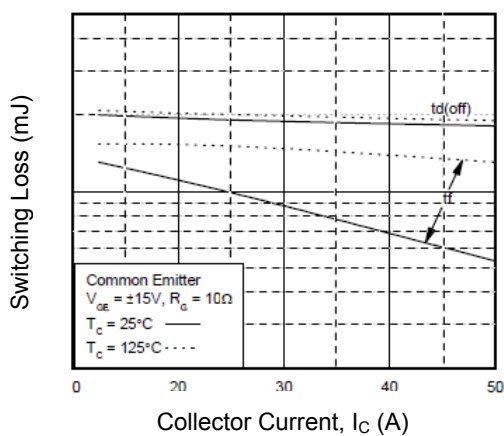

Figure 12. Turn-Off Characteristics vs. Collector Current



## Typical Performance Characteristics (Continued)

Figure 13. Switching Loss vs. Collector Current

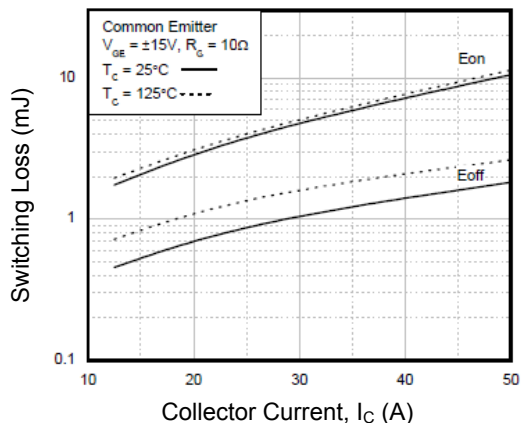

Figure 14. Gate Charge Characteristics

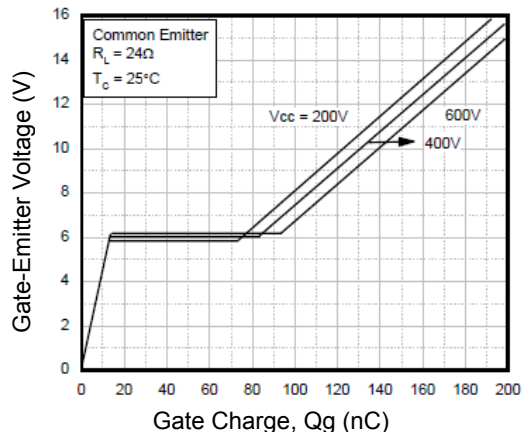

Figure 15. SOA Characteristics

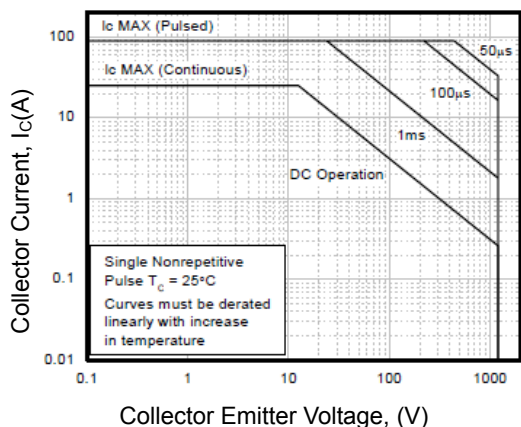

Figure 16. Turn-Off SOA

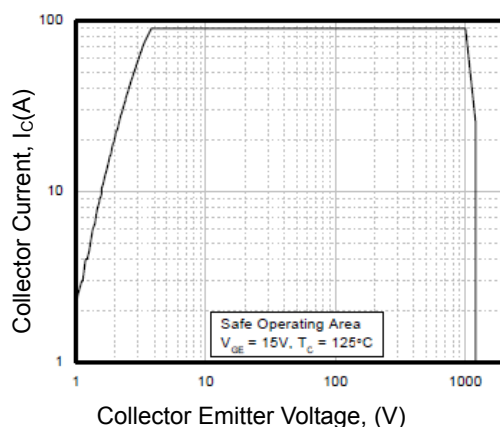
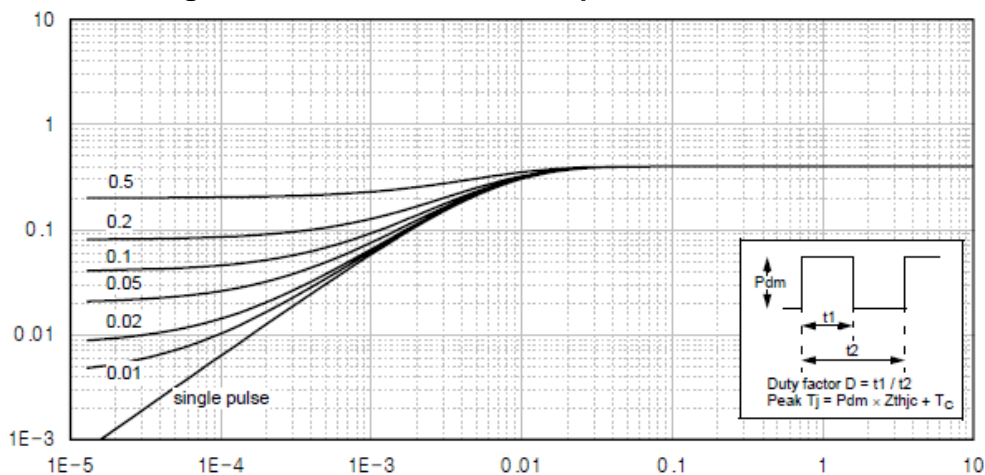

Figure 17. Transient Thermal Impedance of IGBT



# NCE25G120T

## Mechanical Dimensions (continued)

TO-247

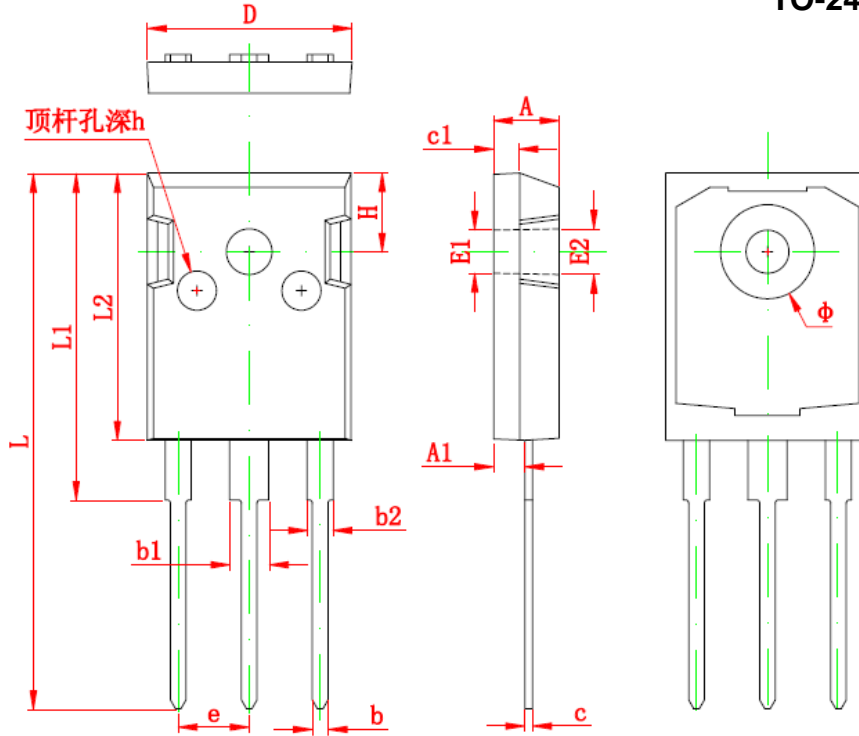

Symbol	Dimensions In Millimeters		Dimensions In Inches	
	Min	Max	Min	Max
A	4.850	5.150	0.191	0.200
A1	2.200	2.600	0.087	0.102
b	1.000	1.400	0.039	0.055
b1	2.800	3.200	0.110	0.126
b2	1.800	2.200	0.071	0.087
c	0.500	0.700	0.020	0.028
c1	1.900	2.100	0.075	0.083
D	15.450	15.750	0.608	0.620
E1	3.500 REF		0.138 REF	
E2	3.600 REF		0.142 REF	
L	40.900	41.300	1.610	1.626
L1	24.800	25.100	0.976	0.988
L2	20.300	20.600	0.799	0.811
φ	7.100	7.300	0.280	0.287
e	5.450 TYP		0.215 TYP	
H	5.980 REF		0.235 REF	
h	0.000	0.300	0.000	0.012

## 注意：

- 新洁能产品说明书中所描述的信息，在没有特殊声明的条件下，不可使用在要求高可靠性的电路中。例如人体供能系统，航天控制系统或其他应用中。在这种高可靠性应用下，可能会导致严重的物理或者材料的损坏。当设计电路中用到新洁能的产品时，请就近咨询代理商。
- 新洁能对客户在超出说明书中提到的额定值使用产品所造成的损失不承担任何责任，即使是瞬间的使用（例如最大额定值，工作环境范围或其他参数）。
- 新洁能对所有产品在单独应用的情况下保证它的性能、典型应用和功能符合说明书中的条件。当使用在客户的产品和设备中，以上条件我们不做保证。为了了解产品在单独使用下无法估测的情况，新洁能建议客户在使用过程中，必须不断的评估和反复的测试实际应用在产品和设备中的问题。
- 新洁能一直在努力为客户提供高质量，高可靠性的产品。但是，所有的半导体产品都有一定的失效概率，这些失效概率可能会导致一些事故的发生，危及人的生命，也可能导致产生浓烟或者大火，招致财产受到损失。当你在设计产品时，必须采用安全指标，这样可以避免事故的发生。这些措施不仅仅是为了保护电路，电路错误预防所做的安全的设计，多余的设计和结构的设计。
- 新洁能的所有产品（包括技术参数和服务）受到当地出口法规的控制，这种产品在没有得到有关部门的同意是不允许出口。
- 没有新洁能预先的许可，这些出版物不能以任何的形式或方式重印或传送，包括影印和记录，或任何信息存储和检索系统。
- 在文中所列的信息（包括电路图和电路参数）仅做泛例参考；这并不是批量生产的保证。新洁能保证说明书中所提到的任何信息都是准确、可靠的，但是不对其使用在任何违反知识产权或者第三方其他产权的情况作保证。
- 所有产品由于工艺/技术的提高等所做的信息变动，新洁能不做通知。当在设计电路时，请参照将要使用的产品的交付说明书。
- 这份说明书所提供的信息时间是在2010年3月。对规格书中信息的更改我们不做通知。

## ATTENTION:

- Any and all NCE products described or contained herein do not have specifications that can handle applications that require extremely high levels of reliability, such as life-support systems, aircraft's control systems, or other applications whose failure can be reasonably expected to result in serious physical and/or material damage. Consult with your NCE representative nearest you before using any NCE products described or contained herein in such applications.
- NCE assumes no responsibility for equipment failures that result from using products at values that exceed, even momentarily, rated values (such as maximum ratings, operating condition ranges, or other parameters) listed in products specifications of any and all NCE products described or contained herein.
- Specifications of any and all NCE products described or contained herein stipulate the performance, characteristics, and functions of the described products in the independent state, and are not guarantees of the performance, characteristics, and functions of the described products as mounted in the customer's products or equipment. To verify symptoms and states that cannot be evaluated in an independent device, the customer should always evaluate and test devices mounted in the customer's products or equipment.
- NCE Power Semiconductor CO.,LTD. strives to supply high-quality high-reliability products. However, any and all semiconductor products fail with some probability. It is possible that these probabilistic failures could give rise to accidents or events that could endanger human lives, that could give rise to smoke or fire, or that could cause damage to other property. When designing equipment, adopt safety measures so that these kinds of accidents or events cannot occur. Such measures include but are not limited to protective circuits and error prevention circuits for safe design, redundant design, and structural design.
- In the event that any or all NCE products(including technical data, services) described or contained herein are controlled under any of applicable local export control laws and regulations, such products must not be exported without obtaining the export license from the authorities concerned in accordance with the above law.
- No part of this publication may be reproduced or transmitted in any form or by any means, electronic or mechanical, including photocopying and recording, or any information storage or retrieval system, or otherwise, without the prior written permission of NCE Power Semiconductor CO.,LTD.
- Information (including circuit diagrams and circuit parameters) herein is for example only ; it is not guaranteed for volume production. NCE believes information herein is accurate and reliable, but no guarantees are made or implied



**Pb Free Product**

<http://www.ncepower.com>

## **NCE25G120T**

regarding its use or any infringements of intellectual property rights or other rights of third parties.

- Any and all information described or contained herein are subject to change without notice due to product/technology improvement, etc. When designing equipment, refer to the "Delivery Specification" for the NCE product that you intend to use.
- This catalog provides information as of Mar. 2010. Specifications and information herein are subject to change without notice.