



JST01 Series 1A TRIACs

DESCRIPTION:

This device is suitable for low power AC switching application, phase control application such as fan speed and temperature modulation control, lighting control and static switching relay.

MAIN FEATURES

Symbol	Value	Unit
$I_T(AV)$	1	A
V_{DRM}/V_{RRM}	600 and 800	V
V_{TM}	≤ 1.5	V

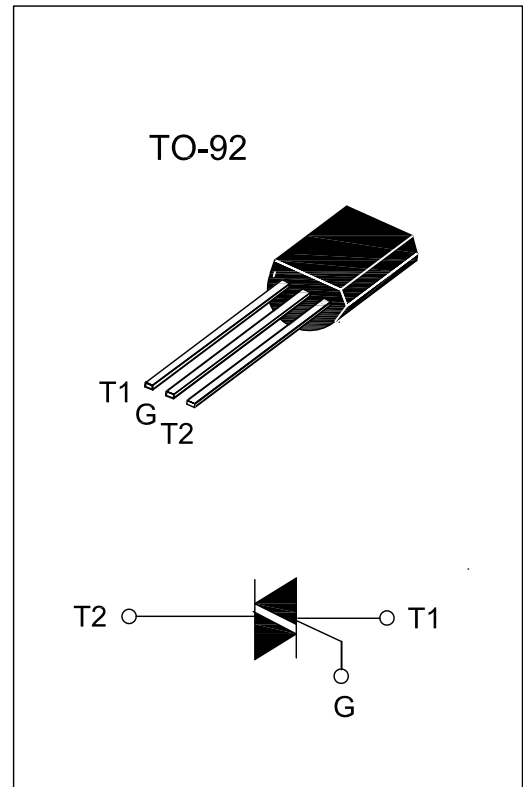

ABSOLUTE MAXIMUM RATINGS

Parameter	Symbol	Value	Unit
Storage junction temperature range	T_{stg}	- 40 to +150	$^{\circ}C$
Operating junction temperature range	T_j	- 40 to +125	$^{\circ}C$
Repetitive Peak Off-state Voltage	$T_j=25^{\circ}C$ V_{DRM}	600 and 800	V
Repetitive Peak Reverse Voltage	$T_j=25^{\circ}C$ V_{RRM}	600 and 800	V
Non repetitive Surge Peak Off-state Voltage	$T_j=25^{\circ}C$ V_{DSM}	700 and 900	V
Non repetitive Peak Reverse Voltage	$T_j=25^{\circ}C$ V_{RSM}	700 and 900	V
RMS on-state current (full sine wave)	$T_c=110^{\circ}C$ $I_T(RMS)$	1	A
Non repetitive surge peak on-state current (One Full Cycle,Sine Wave, $T_c=110^{\circ}C$)	$t_p=10ms$ I_{TSM}	16	A
	$t_p=8.3ms$	17.6	A
I^2t Value for fusing	$t_p=10ms$ I^2t	1.28	A^2s
Peak gate current	$t_p \leq 2\mu s, T_j=80^{\circ}C$ I_{GM}	2	A
Average gate power dissipation	$t_p \leq 10mS, T_j=80^{\circ}C$ $P_{G(AV)}$	0.5	W
Peak gate power dissipation	$t_p \leq 10mS, T_j=80^{\circ}C$ P_{GM}	5	W

ELECTRICAL CHARACTERISTICS(T_j=25°C unless otherwise specified)

Symbol	Test Condition	Quadrant		Ratings	Unit
I _{GT}	V _D =12V R _L =33Ω	I-II-III IV	MAX.	5 10	mA
V _{GT}		ALL	MAX.	1.3	V
V _{GD}	V _D =V _{DRM} R _L =3.3KΩ T _j =125°C	ALL	MIN.	0.2	V
I _H	I _T =200mA		MAX.	5	mA
dV/dt	V _D =67%V _{DRM} gate open T _j =125°C		MIN.	5	V/μs
(dV/dt) _c	(dI/dt) _c =0.3A/ms T _j =125°C		MIN.	1	V/μs

STATIC CHARACTERISTICS

Symbol	Parameter		Value(MAX.)	Unit
V _{TM}	I _{TM} =2A, t _p =380μs	T _j =25°C	1.5	V
I _{DRM} I _{RRM}	V _D =V _{DRM} V _R =V _{RRM}	T _j =25°C	10	μA
		T _j =125°C	500	μA

THERMAL RESISTANCES

Symbol	Parameter		Value	Unit
R _{th} (J-C)	Junction to Case(AC)	TO-92	60	°C/W

ORDERING INFORMATION

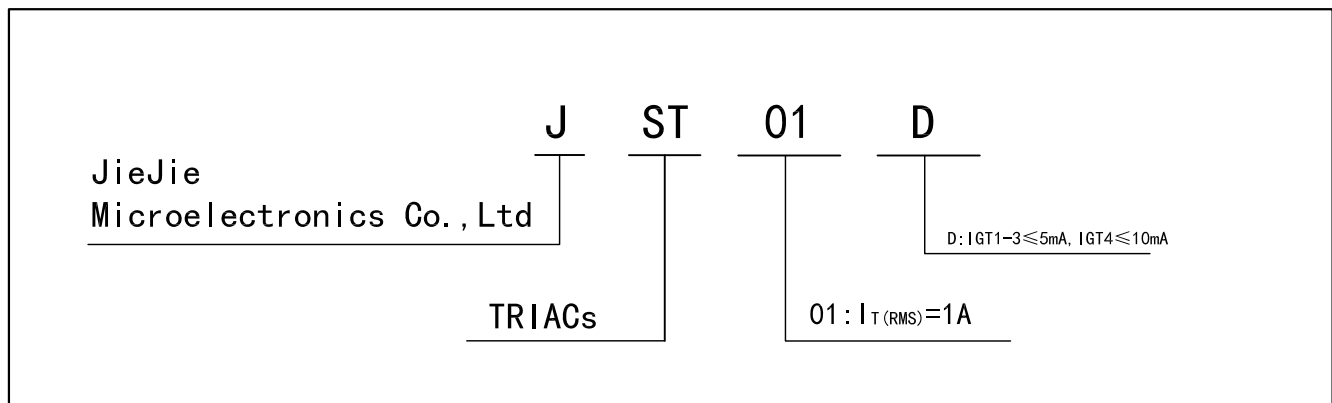

PACKAGE MECHANICAL DATA

TO-92(TO-226AA)

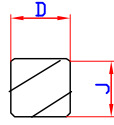
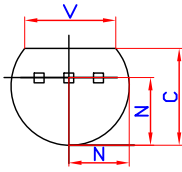

SECTION X-X

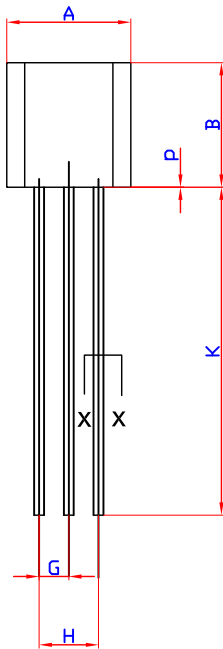

Ref.	Dimensions			
	Millimeters		Inches	
	Min.	Max.	Min.	Max.
A	4.45	5.2	0.175	0.205
B	4.32	5.33	0.170	0.210
C	3.18	4.19	0.125	0.165
D	0.407	0.533	0.016	0.021
G	1.15	1.39	0.045	0.055
H	2.42	2.66	0.095	0.105
J	0.39	0.50	0.015	0.020
K	12.70	-	0.500	-
N	2.04	2.66	0.080	0.105
P	-	2.54	-	0.100
V	3.43	-	0.135	-

FIG.1: Maximum power dissipation versus average on-state current.

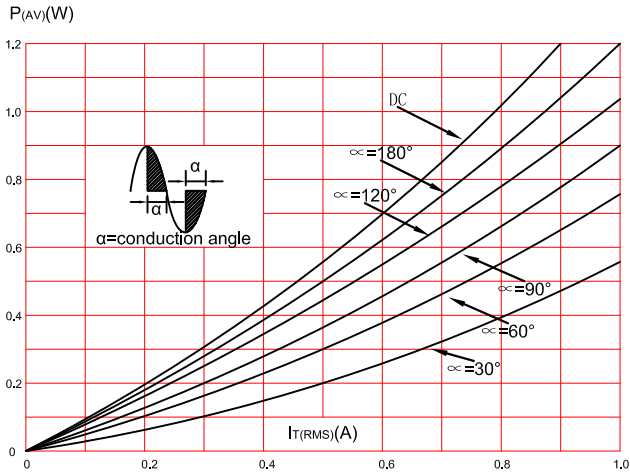

FIG.3: On-state characteristics (maximum values)

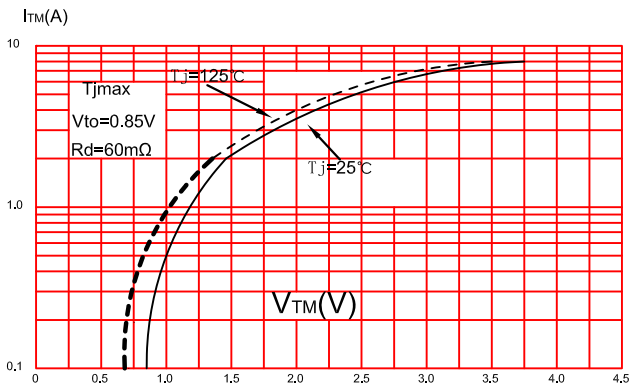

FIG.5: Relative variation of gate trigger current, holding current and latching current versus junction temperature (typical values).

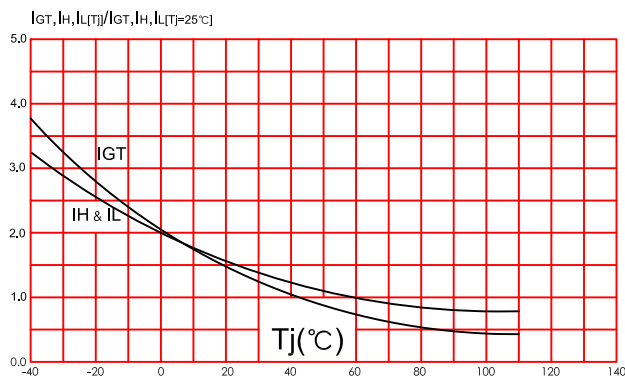

FIG.2: RMS on-state current versus case temperature.

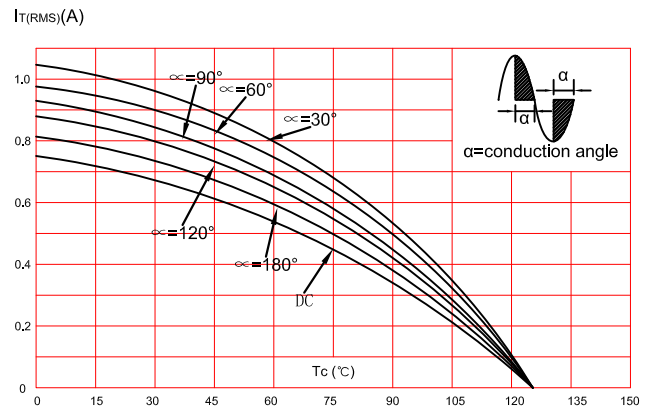

FIG.4: Surge peak on-state current versus number of cycles.

