

General Description

The MIC49150 is a high-bandwidth, low-dropout, 1.5A voltage regulator ideal for powering core voltages of low-power microprocessors. The MIC49150 implements a dual supply configuration allowing for very low output impedance and very fast transient response.

The MIC49150 requires a bias input supply and a main input supply, allowing for ultra-low input voltages on the main supply rail. The input supply operates from 1.4V to 6.5V and the bias supply requires between 3V and 6.5V for proper operation. The MIC49150 offers fixed output voltages from 0.9V to 1.8V and adjustable output voltages down to 0.9V.

The MIC49150 requires a minimum of output capacitance for stability, working optimally with small ceramic capacitors.

The MIC49150 is available in an 8-pin power MSOP package and a 5-pin S-Pak. Its operating temperature range is -40°C to $+125^{\circ}\text{C}$.

Data sheets and support documentation can be found on Micrel's web site at www.micrel.com.

Features

- Input Voltage Range:
 - V_{IN} : 1.4V to 6.5V
 - V_{BIAS} : 3.0V to 6.5V
- **Stable with 1 μF ceramic capacitor**
- $\pm 1\%$ initial tolerance
- Maximum dropout voltage ($V_{\text{IN}} - V_{\text{OUT}}$) of 500mV over temperature
- **Adjustable output voltage down to 0.9V**
- Ultra fast transient response (Up to 10MHz bandwidth)
- Excellent line and load regulation specifications
- Logic controlled shutdown option
- Thermal shutdown and current limit protection
- Power MSOP-8 and S-Pak packages
- Junction temperature range: -40°C to 125°C

Applications

- Graphics processors
- PC add-in cards
- Microprocessor core voltage supply
- Low voltage digital ICs
- High efficiency linear power supplies
- SMPS post regulators

Typical Application

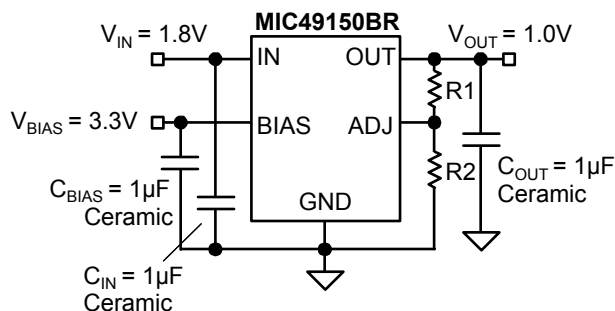

**Low Voltage,
Fast Transient Response Regulator**

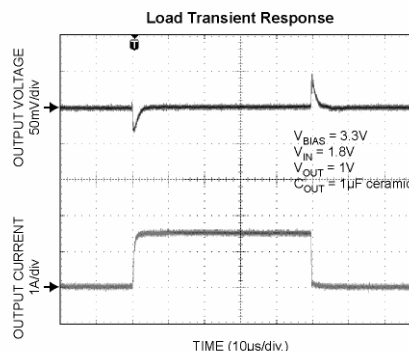

Ordering Information

Part Number		Output Current	Voltage	Junction Temp. Range	Package
Standard	Pb-Free / RoHS Compliant				
MIC49150-0.9BMM	MIC49150-0.9YMM	1.5A	0.9V	-40° to +125°C	8-Pin Power MSOP
MIC49150-1.2BMM	MIC49150-1.2YMM	1.5A	1.2V	-40° to +125°C	8-Pin Power MSOP
MIC49150-1.5BMM	MIC49150-1.5YMM	1.5A	1.5V	-40° to +125°C	8-Pin Power MSOP
MIC49150-1.8BMM	MIC49150-1.8YMM	1.5A	1.8V	-40° to +125°C	8-Pin Power MSOP
MIC49150BMM	MIC49150YMM	1.5A	Adj.	-40° to +125°C	8-Pin Power MSOP
MIC49150-0.9BR	MIC49150-0.9WR*	1.5A	0.9V	-40° to +125°C	5-Pin S-PAK
MIC49150-1.2BR	MIC49150-1.2WR*	1.5A	1.2V	-40° to +125°C	5-Pin S-PAK
MIC49150-1.5BR	MIC49150-1.5WR*	1.5A	1.5V	-40° to +125°C	5-Pin S-PAK
MIC49150-1.8BR	MIC49150-1.8WR*	1.5A	1.8V	-40° to +125°C	5-Pin S-PAK
MIC49150BR	MIC49150WR*	1.5A	Adj.	-40° to +125°C	5-Pin S-PAK

* RoHS Compliant with 'high-melting solder' exemption.

Pin Configuration

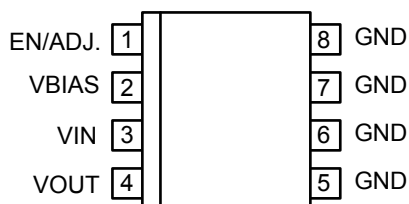

8-Pin Power MSPO (MM)

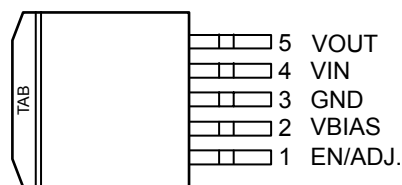

5-Pin S-Pak (R)

Pin Description

Pin Number 8-MSOP	Pin Number 5-SPak	Pin Name	Pin Name
1	1	EN	Enable (Input): CMOS compatible input. Logic high = enable, logic low = shutdown.
		ADJ	Adjustable regulator feedback input. Connect to resistor voltage divider.
2	2	VBIAS	Input Bias Voltage for powering all circuitry on the regulator with the exception of the output power device.
3	4	VIN	Input voltage which supplies current to the output power device.
4	5	OUT	Regulator Output.
5/6/7/8	3	GND	Ground (TAB is connected to ground on S-Pak).

Absolute Maximum Ratings⁽¹⁾

Supply Voltage (V_{IN})	8V
Bias Supply Voltage (V_{BIAS})	8V
Enable Input Voltage (V_{EN})	8V
Power Dissipation	Internally Limited
ESD Rating ⁽³⁾	4kV

Operating Ratings⁽²⁾

Supply Voltage (V_{IN})	1.4V to 6.5V
Bias Supply Voltage (V_{BIAS})	3V to 6.5V
Enable Input Voltage (V_{EN})	0V to 6.5V
Junction Temperature (T_J)	$-40^{\circ}\text{C} \leq T_J \leq +125^{\circ}\text{C}$
Package Thermal Resistance	
MSOP-8 (θ_{JA})	80°C/W
S-Pak (θ_{JC})	2°C/W

Electrical Characteristics⁽⁴⁾

$T_A = 25^{\circ}\text{C}$ with $V_{BIAS} = V_{OUT} + 2.1\text{V}$; $V_{IN} = V_{OUT} + 1\text{V}$; **bold** values indicate $-40^{\circ}\text{C} \leq T_J \leq +125^{\circ}\text{C}$, unless noted⁽⁵⁾.

Parameter	Condition	Min	Typ	Max	Units
Output Voltage Accuracy	At 25°C	-1		+1	%
	Over temperature range	-2		+2	%
Line Regulation	$V_{IN} = V_{OUT} + 1\text{V}$ to 6.5V	-0.1	0.01	+0.1	%/V
Load Regulation	$I_L = 0\text{mA}$ to 1.5A		0.2	1	%
				1.5	%
Dropout Voltage ($V_{IN} - V_{OUT}$)	$I_L = 750\text{mA}$		130	200	mV
				300	mV
			280	400	mV
Dropout Voltage ($V_{BIAS} - V_{OUT}$), Note 5	$I_L = 750\text{mA}$ $I_L = 1.5\text{A}$		1.3	1.9	V
			1.65	2.1	V
					V
Ground Pin Current, Note 6	$I_L = 0\text{mA}$ $I_L = 1.5\text{A}$		15	25	mA
			15	30	mA
					mA
Ground Pin Current in Shutdown	$V_{EN} \leq 0.6\text{V}$, ($I_{BIAS} + I_{CC}$), Note 7		0.5	1	μA
Current thru V_{BIAS}	$I_L = 0\text{mA}$ $I_L = 1.5\text{A}$		9	15	mA
			32	25	mA
Current Limit	MIC49150	1.6	2.3	3.4	A
				4	A
Enable Input (Note 7)					
Enable Input Threshold (Fixed Voltage only)	Regulator enable	1.6			V
	Regulator shutdown			0.6	V
Enable Pin Input Current	Independent of state		0.1	1	μA
Reference					
Reference Voltage		0.891	0.9	0.909	V
		0.882		0.918	V

Notes:

- Exceeding the absolute maximum rating may damage the device.
- The device is not guaranteed to function outside its operating rating.
- Devices are ESD sensitive. Handling precautions recommended. Human body model, 1.5kΩ in series with 100pF.
- Specification for packaged product only.
- For $V_{OUT} \leq 1\text{V}$, V_{BIAS} dropout specification does not apply due to a minimum 3V V_{BIAS} input.
- $I_{GND} = I_{BIAS} + (I_{IN} - I_{OUT})$. At high loads, input current on V_{IN} will be less than the output current, due to drive current being supplied by V_{BIAS} .
- Fixed output voltage versions only.

Typical Characteristics

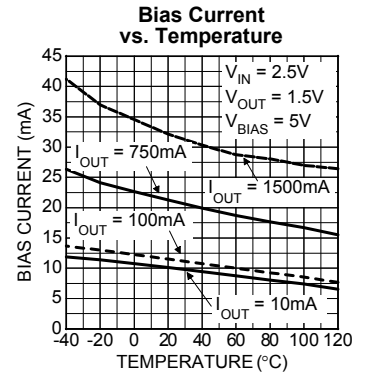
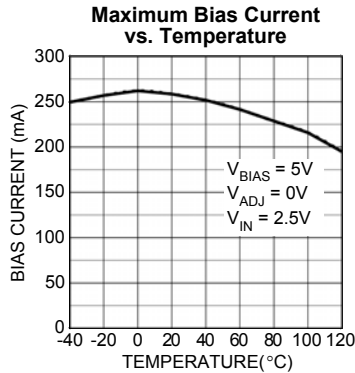
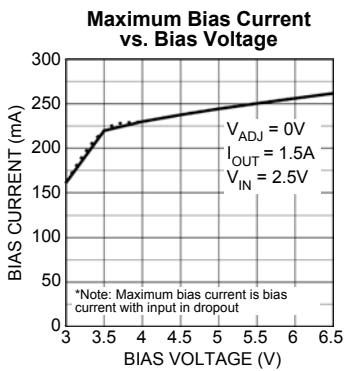
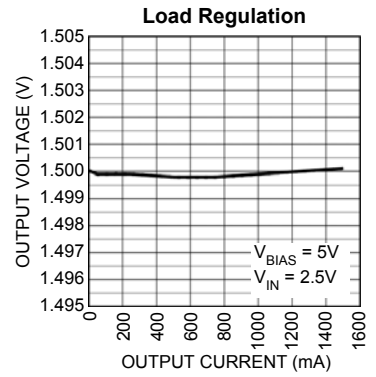
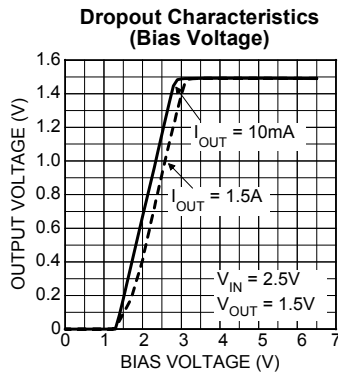
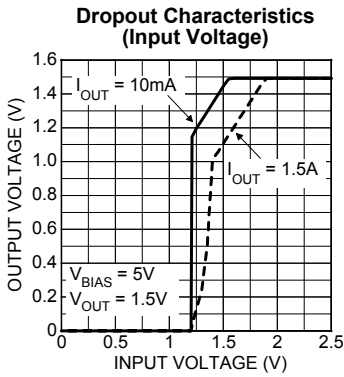
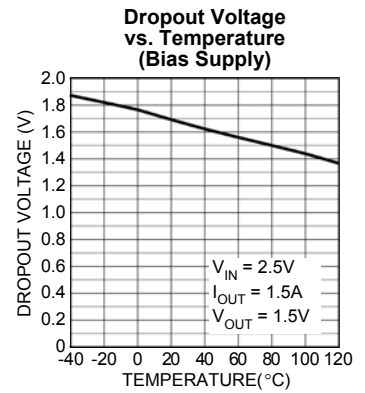
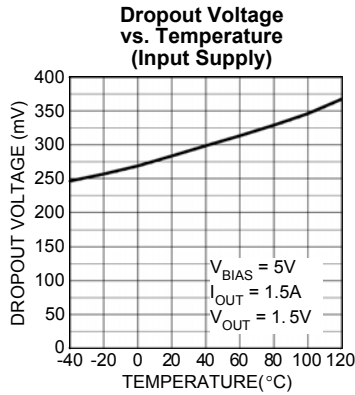
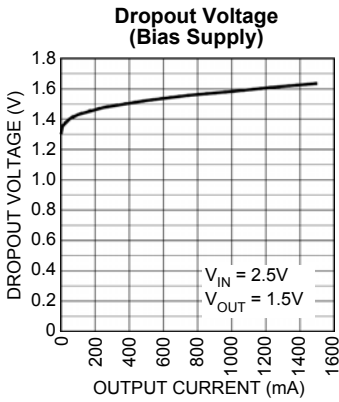
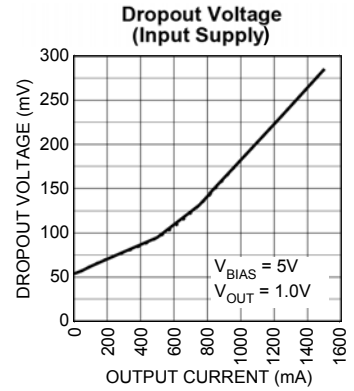
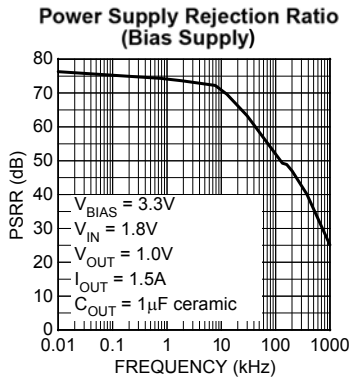
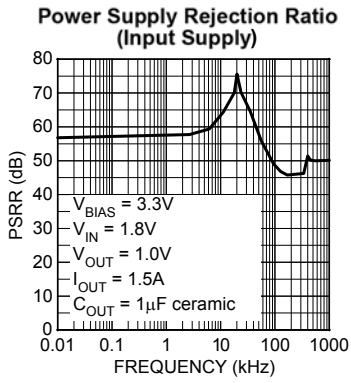

Typical Characteristics (cont.)

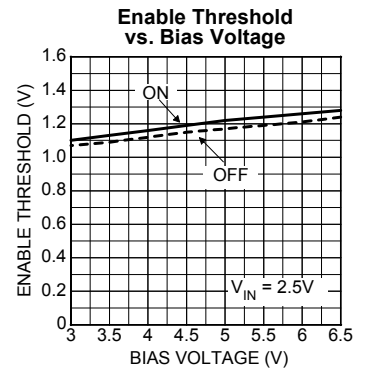
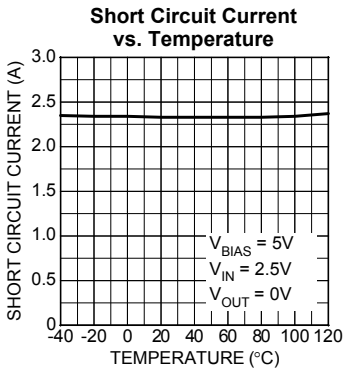
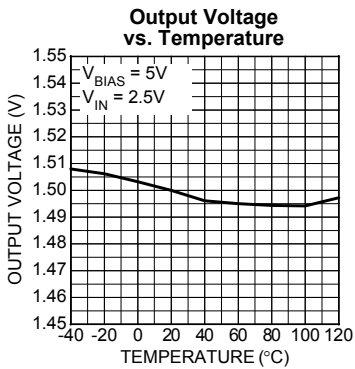
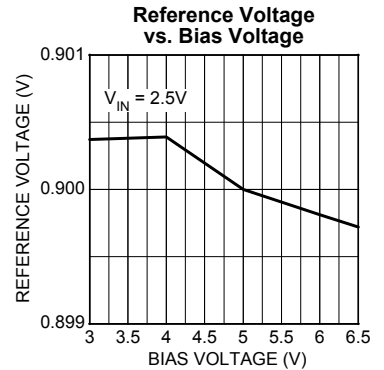
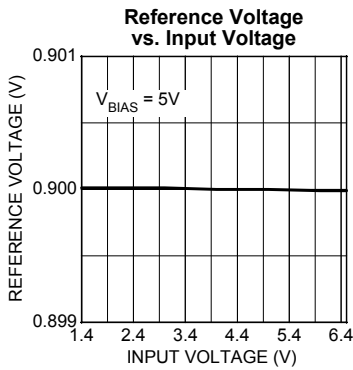
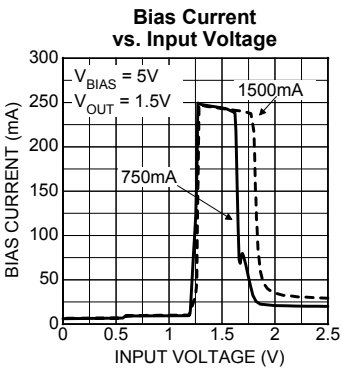
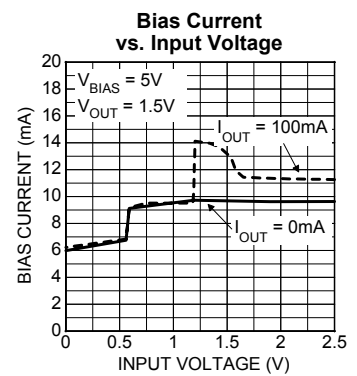
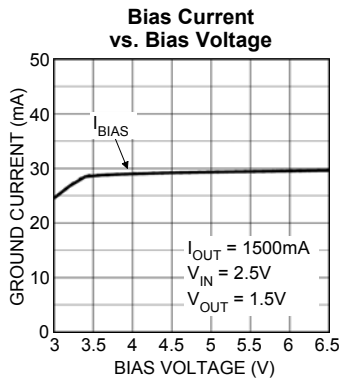
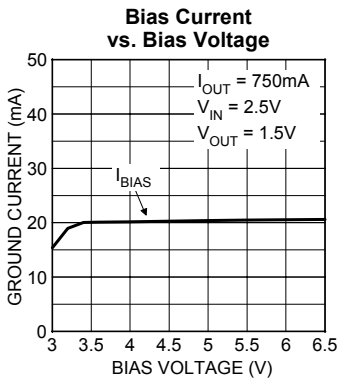
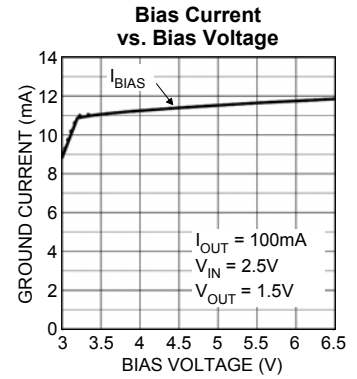
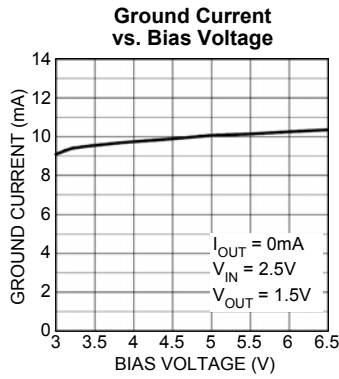
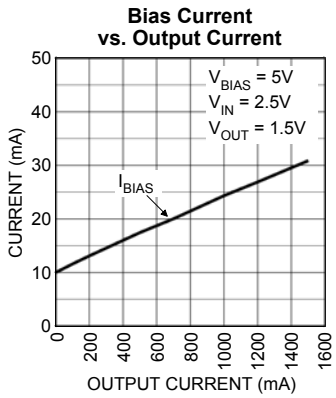

Typical Characteristics (cont.)

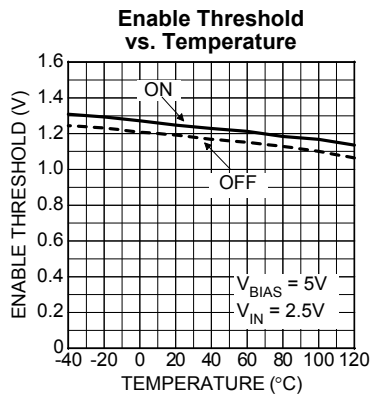

Functional Characteristics

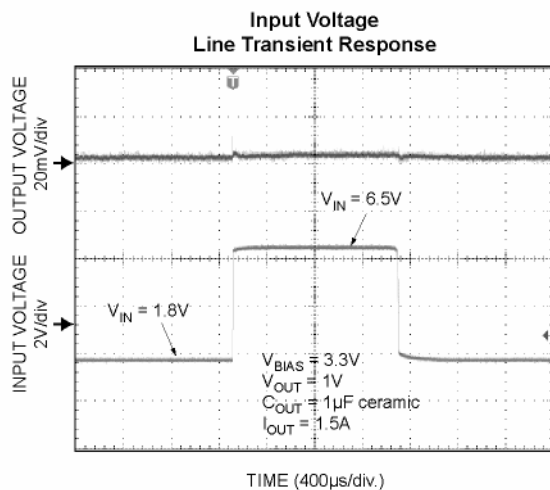
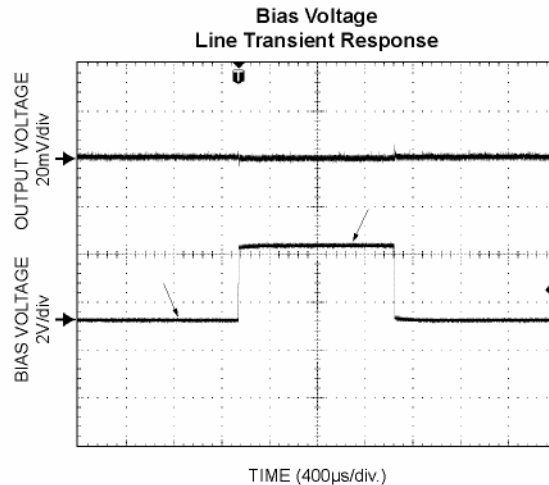
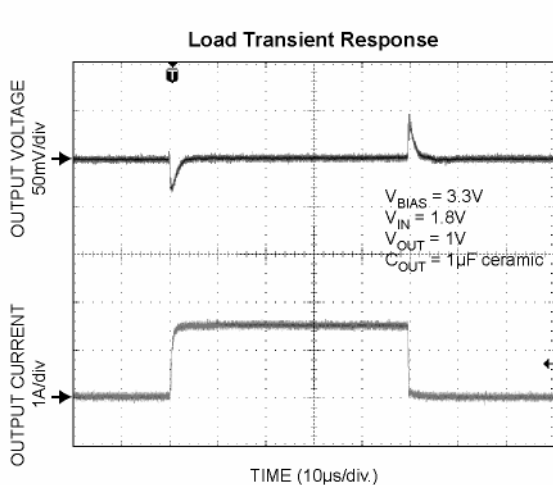

Functional Diagram

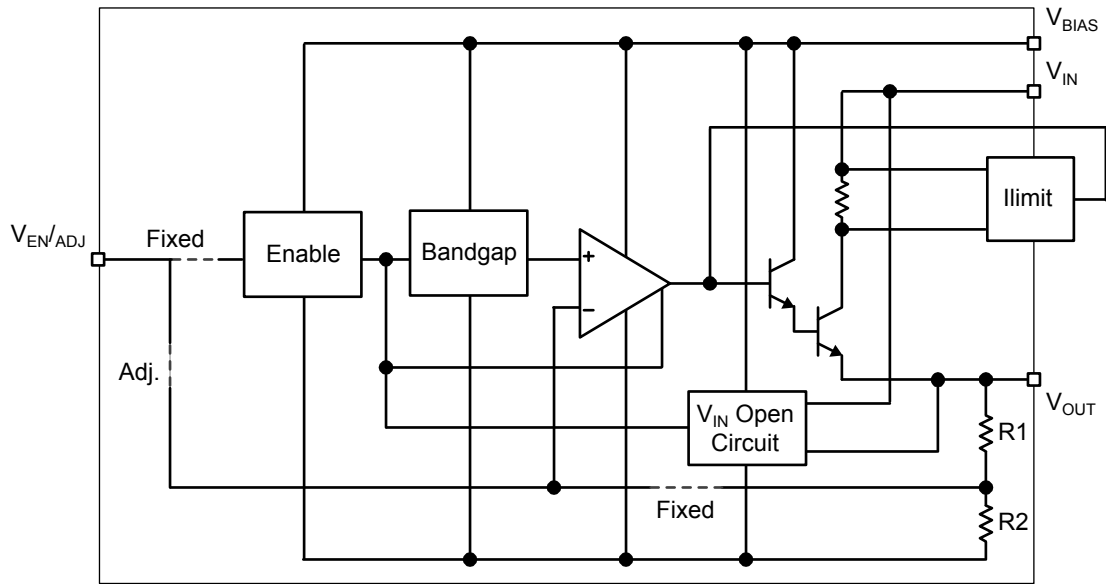

Application Information

The MIC49150 is an ultra-high performance, low-dropout linear regulator designed for high current applications requiring fast transient response. The MIC49150 utilizes two input supplies, significantly reducing dropout voltage, perfect for low-voltage, DC-to-DC conversion. The MIC49150 requires a minimum of external components and obtains a bandwidth of up to 10MHz. As a μ Cap regulator, the output is tolerant of virtually any type of capacitor including ceramic type and tantalum type capacitors.

The MIC49150 regulator is fully protected from damage due to fault conditions, offering linear current limiting and thermal shutdown.

Bias Supply Voltage

V_{BIAS} , requiring relatively light current, provides power to the control portion of the MIC49150. V_{BIAS} requires approximately 33mA for a 1.5A load current. Dropout conditions require higher currents. Most of the biasing current is used to supply the base current to the pass transistor. This allows the pass element to be driven into saturation, reducing the dropout to 300mV at a 1.5A load current. Bypassing on the bias pin is recommended to improve performance of the regulator during line and load transients. Small ceramic capacitors from V_{BIAS} to ground help reduce high frequency noise from being injected into the control circuitry from the bias rail and are good design practice. Good bypass techniques typically include one larger capacitor such as 1 μ F ceramic and smaller valued capacitors such as 0.01 μ F or 0.001 μ F in parallel with that larger capacitor to decouple the bias supply. The V_{BIAS} input voltage must be 1.6V above the output voltage with a minimum V_{BIAS} input voltage of 3 volts.

Input Supply Voltage

V_{IN} provides the high current to the collector of the pass transistor. The minimum input voltage is 1.4V, allowing con-version from low voltage supplies.

Output Capacitor

The MIC49150 requires a minimum of output capacitance to maintain stability. However, proper capacitor selection is important to ensure desired transient response. The MIC49150 is specifically designed to be stable with virtually any capacitance value and ESR. A 1 μ F ceramic chip capacitor should satisfy most applications. Output capacitance can be increased without bound. See "Typical Characteristic" for examples of load transient response.

X7R dielectric ceramic capacitors are recommended because of their temperature performance. X7R-type capacitors change capacitance by 15% over their operating temperature range and are the most stable

type of ceramic capacitors. Z5U and Y5V dielectric capacitors change value by as much as 50% and 60% respectively over their operating temperature ranges. To use a ceramic chip capacitor with Y5V dielectric, the value must be much higher than an X7R ceramic or a tantalum capacitor to ensure the same capacitance value over the operating temperature range. Tantalum capacitors have a very stable dielectric (10% over their operating temperature range) and can also be used with this device.

Input Capacitor

An input capacitor of 1 μ F or greater is recommended when the device is more than 4" away from the bulk supply capacitance, or when the supply is a battery. Small, surface-mount, ceramic chip capacitors can be used for the bypassing. The capacitor should be placed within 1" of the device for optimal performance. Larger values will help to improve ripple rejection by bypassing the input to the regulator, further improving the integrity of the output voltage.

Thermal Design

Linear regulators are simple to use. The most complicated design parameters to consider are thermal characteristics. Thermal design requires the following application-specific parameters:

- Maximum ambient temperature (T_A)
- Output current (I_{OUT})
- Output voltage (V_{OUT})
- Input voltage (V_{IN})
- Ground current (I_{GND})

First, calculate the power dissipation of the regulator from these numbers and the device parameters from this datasheet.

$$P_D = V_{IN} \times I_{IN} + V_{BIAS} \times I_{BIAS} - V_{OUT} \times I_{OUT}$$

The input current will be less than the output current at high output currents as the load increases. The bias current is a sum of base drive and ground current. Ground current is constant over load current. Then the heat sink thermal resistance is determined with this formula:

$$\theta_{SA} = \left(\frac{T_{J(MAX)} - T_A}{P_D} \right) - (\theta_{JC} + \theta_{CS})$$

The heat sink may be significantly reduced in applications where the maximum input voltage is known and large compared with the dropout voltage. Use a series input resistor to drop excessive voltage and distribute the heat between this resistor and the regulator. The low-dropout properties of the MIC49150 allow significant reductions in regulator power dissipation and the associated heat sink without compromising performance. When this technique is employed, a

capacitor of at least 1 μ F is needed directly between the input and regulator ground. Refer to “*Application Note 9*” for further details and examples on thermal design and heat sink specification.

Minimum Load Current

The MIC49150, unlike most other high current regulators, does not require a minimum load to maintain output voltage regulation.

Power MSOP-8 Thermal Characteristics

One of the secrets of the MIC49150’s performance is its power MSOP-8 package featuring half the thermal resistance of a standard MSOP-8 package. Lower thermal resistance means more output current or higher input voltage for a given package size.

Lower thermal resistance is achieved by joining the four ground leads with the die attach paddle to create a single-piece electrical and thermal conductor. This concept has been used by MOSFET manufacturers for years, proving very reliable and cost effective for the user.

Thermal resistance consists of two main elements, θ_{JC} (junction-to-case thermal resistance) and θ_{CA} (case-to-ambient thermal resistance). See Figure 1. θ_{JC} is the resistance from the die to the leads of the package. θ_{CA} is the resistance from the leads to the ambient air and it includes θ_{CS} (case-to-sink thermal resistance) and θ_{SA} (sink-to-ambient thermal resistance).

Using the power MSOP-8 reduces the θ_{JC} dramatically and allows the user to reduce θ_{CA} . The total thermal resistance, θ_{JA} (junction-to-ambient thermal resistance) is the limiting factor in calculating the maximum power dissipation capability of the device. Typically, the power MSOP-8 has a θ_{JA} of 80°C/W, this is significantly lower than the standard MSOP-8 which is typically 160°C/W. θ_{CA} is reduced because pins 5 through 8 can now be soldered directly to a ground plane which significantly reduces the case-to-sink thermal resistance and sink to ambient thermal resistance.

Low-dropout linear regulators from Micrel are rated to a maximum junction temperature of 125°C. It is important not to exceed this maximum junction temperature during operation of the device. To prevent this maximum junction temperature from being exceeded, the appropriate ground plane heat sink must be used.

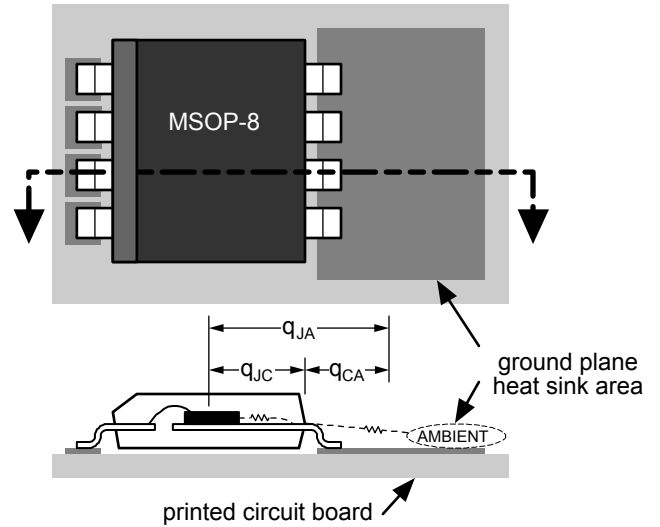

Figure 1. Thermal Resistance

Figure 2 shows copper area versus power dissipation with each trace corresponding to a different temperature rise above ambient.

From these curves, the minimum area of copper necessary for the part to operate safely can be determined. The maximum allowable temperature rise must be calculated to determine operation along which curve.

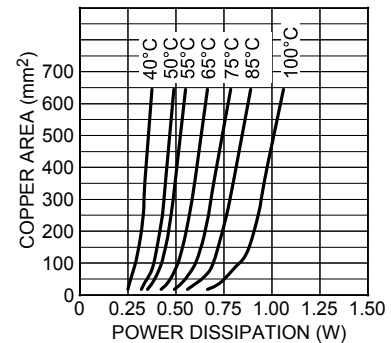

Figure 2. Copper Area vs. Power-MSOP Power Dissipation (ΔT_{JA})

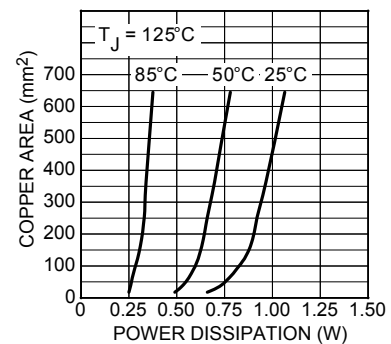

Figure 3. Copper Area vs. Power-MSOP Power Dissipation (T_A)

$$\Delta T = T_{J(\max)} - T_{A(\max)}$$

$$T_{J(\max)} = 125^{\circ}\text{C}$$

$T_{A(\max)}$ = maximum ambient operating temperature

For example, the maximum ambient temperature is 50°C , the ΔT is determined as follows:

$$\Delta T = 125^{\circ}\text{C} - 50^{\circ}\text{C}$$

$$\Delta T = 75^{\circ}\text{C}$$

Using Figure 2, the minimum amount of required copper can be determined based on the required power dissipation. Power dissipation in a linear regulator is calculated as follows:

$$P_D = V_{IN} \times I_{IN} + V_{BIAS} \times I_{BIAS} - V_{OUT} \times I_{OUT}$$

Using a typical application of 750mA output current, 1.2V output voltage, 1.8V input voltage and 3.3V bias voltage, the power dissipation is as follows:

$$P_D = (1.8\text{V}) \times (730\text{mA}) + 3.3\text{V}(30\text{mA}) - 1.2\text{V}(750\text{mA})$$

At full current, a small percentage of the output current is supplied from the bias supply, therefore the input current is less than the output current.

$$P_D = 513\text{mW}$$

From Figure 2, the minimum current of copper required to operate this application at a ΔT of 75°C is less than 100mm^2 .

Quick Method

Determine the power dissipation requirements for the design along with the maximum ambient temperature at which the device will be operated. Refer to Figure 3, which shows safe operating curves for three different ambient temperatures: 25°C , 50°C and 85°C . From these curves, the minimum amount of copper can be determined by knowing the maximum power dissipation required. If the maximum ambient temperature is 50°C and the power dissipation is as above, 513mW, the curve in Figure 3 shows that the required area of copper is less than 100mm^2 .

The θ_{JA} of this package is ideally $80^{\circ}\text{C}/\text{W}$, but it will vary depending upon the availability of copper ground plane to which it is attached.

Adjustable Regulator Design

The MIC49150 adjustable version allows programming the output voltage anywhere between 0.9V and 5V. Two resistors are used. The resistor value between V_{OUT} and the adjust pin should not exceed $10\text{k}\Omega$. Larger values can cause instability. The resistor values are calculated by:

$$R1 = R2 \times \left(\frac{V_{OUT}}{0.9} - 1 \right)$$

Where V_{OUT} is the desired output voltage.

Enable

The fixed output voltage versions of the MIC49150 feature an active high enable input (EN) that allows on-off control of the regulator. Current drain reduces to "zero" when the device is shutdown, with only microamperes of leakage current. The EN input has TTL/CMOS compatible thresholds for simple logic interfacing. EN may be directly tied to V_{IN} and pulled up to the maximum supply voltage.

Package Information

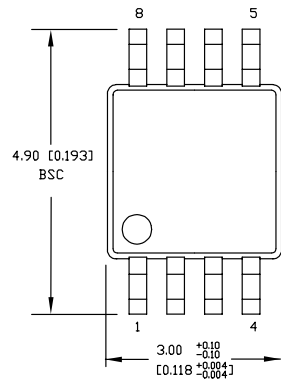

TOP VIEW

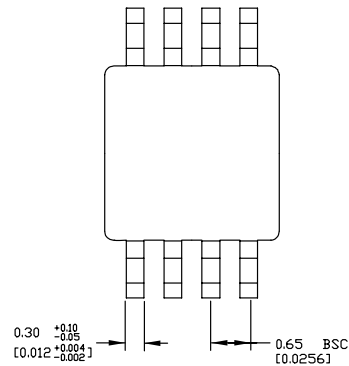

BOTTOM VIEW

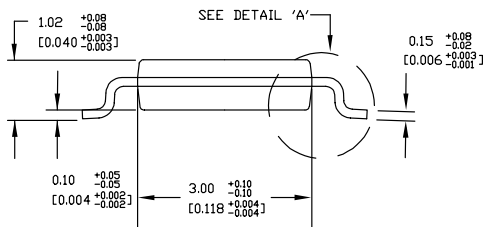

SIDE VIEW

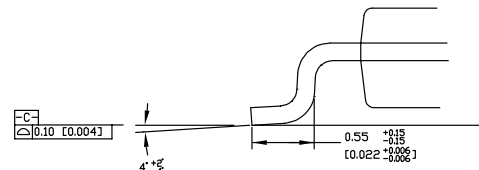

DETAIL A

NOTES:

1. DIMENSIONS ARE IN MM [INCHES].
 2. CONTROLLING DIMENSION: MM
- ⚠ DIMENSION DOES NOT INCLUDE MOLD FLASH OR PROTRUSIONS, EITHER OF WHICH SHALL NOT EXCEED 0.20 [0.008] PER SIDE.

8-Pin MSOP (MM)

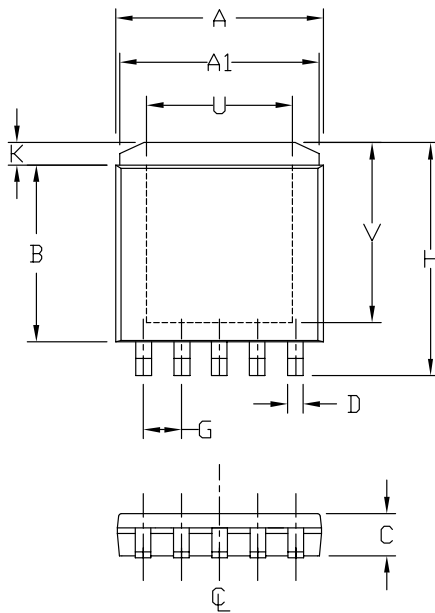

5-Pin S-Pak (R)

	INCHES		MILLIMETERS	
A	0.365	0.375	9.27	9.52
A1	0.350	0.360	8.89	9.14
B	0.310	0.320	7.87	8.13
K	0.070	0.080	1.78	2.03
D	0.025	0.031	0.63	0.79
E	0.010	BSC	0.25	BSC
G	0.067	BSC	1.70	BSC
H	0.410	0.420	10.41	10.67
K	0.030	0.050	0.76	1.27
L	0.001	0.005	0.03	0.13
M	0.035	0.045	0.89	1.14
N	0.010	BSC	0.25	BSC
P	0.031	0.041	0.79	1.04
R	0"	6"	0"	6"
U	0.256	BSC	6.50	BSC
V	0.316	BSC	8.03	BSC

1. DIMENSION DOES NOT INCLUDE MOLD FLASH OR PROTRUSIONS.
2. DIMENSION INCLUDES PLATING THICKNESS

MICREL, INC. 2180 FORTUNE DRIVE SAN JOSE, CA 95131 USA
TEL +1 (408) 944-0800 FAX +1 (408) 474-1000 WEB <http://www.micrel.com>

The information furnished by Micrel in this data sheet is believed to be accurate and reliable. However, no responsibility is assumed by Micrel for its use. Micrel reserves the right to change circuitry and specifications at any time without notification to the customer.

Micrel Products are not designed or authorized for use as components in life support appliances, devices or systems where malfunction of a product can reasonably be expected to result in personal injury. Life support devices or systems are devices or systems that (a) are intended for surgical implant into the body or (b) support or sustain life, and whose failure to perform can be reasonably expected to result in a significant injury to the user. A Purchaser's use or sale of Micrel Products for use in life support appliances, devices or systems is a Purchaser's own risk and Purchaser agrees to fully indemnify Micrel for any damages resulting from such use or sale.

© 2003 Micrel, Incorporated.