



FGA15N120FTD

1200V, 15A Field Stop Trench IGBT

Features

- Field stop trench technology
- High speed switching
- Low saturation voltage: $V_{CE(sat)} = 1.58V @ I_C = 15A$
- High input impedance
- RoHS compliant

General Description

Using advanced field stop trench technology, Fairchild's 1200V trench IGBTs offer superior conduction and switching performances, and easy parallel operation with exceptional avalanche ruggedness. This device is designed for soft switching applications.

Applications

- Induction heating and Microwave oven
- Soft switching applications

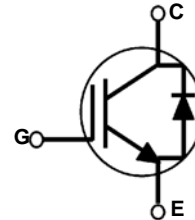
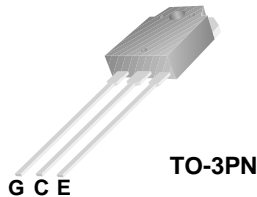

Absolute Maximum Ratings

Symbol	Description	Ratings	Units
V_{CES}	Collector to Emitter Voltage	1200	V
V_{GES}	Gate to Emitter Voltage	± 25	V
I_C	Collector Current @ $T_C = 25^\circ C$	30	A
	Collector Current @ $T_C = 100^\circ C$	15	A
$I_{CM} (1)$	Pulsed Collector Current	45	A
I_F	Diode Continuous Forward Current @ $T_C = 100^\circ C$	15	A
I_{FM}	Diode Maximum Forward Current	90	A
P_D	Maximum Power Dissipation @ $T_C = 25^\circ C$	220	W
	Maximum Power Dissipation @ $T_C = 100^\circ C$	88	W
T_J	Operating Junction Temperature	-55 to +150	$^\circ C$
T_{stg}	Storage Temperature Range	-55 to +150	$^\circ C$
T_L	Maximum Lead Temp. for soldering Purposes, 1/8" from case for 5 seconds	300	$^\circ C$

Notes:

1: Repetitive rating: Pulse width limited by max. junction temperature

Thermal Characteristics

Symbol	Parameter	Typ.	Max.	Units
$R_{\theta JC}(\text{IGBT})$	Thermal Resistance, Junction to Case	-	0.57	$^\circ C/W$
$R_{\theta JC}(\text{Diode})$	Thermal Resistance, Junction to Case	-	2.1	$^\circ C/W$
$R_{\theta JA}$	Thermal Resistance, Junction to Ambient	-	62.5	$^\circ C/W$

Package Marking and Ordering Information

Device Marking	Device	Package	Reel Size	Tape Width	Quantity
FGA15N120FTD	FGA15N120FTDTU	TO-3PN	-	-	30

Electrical Characteristics of the IGBT T_C = 25°C unless otherwise noted

Symbol	Parameter	Test Conditions	Min.	Typ.	Max.	Units
Off Characteristics						
BV _{CES}	Collector to Emitter Breakdown Voltage	V _{GE} = 0V, I _C = 1mA	1200	-	-	V
I _{CES}	Collector Cut-Off Current	V _{CE} = V _{CES} , V _{GE} = 0V	-	-	1	mA
I _{GES}	G-E Leakage Current	V _{GE} = V _{GES} , V _{CE} = 0V	-	-	±250	nA
On Characteristics						
V _{GE(th)}	G-E Threshold Voltage	I _C = 15mA, V _{CE} = V _{GE}	3.5	6	7.5	V
V _{CE(sat)}	Collector to Emitter Saturation Voltage	I _C = 15A, V _{GE} = 15V	-	1.58	2	V
		I _C = 15A, V _{GE} = 15V, T _C = 125°C	-	1.83	-	V
Dynamic Characteristics						
C _{ies}	Input Capacitance	V _{CE} = 30V, V _{GE} = 0V, f = 1MHz	-	2350	-	pF
C _{oes}	Output Capacitance		-	70	-	pF
C _{res}	Reverse Transfer Capacitance		-	45	-	pF
Switching Characteristics						
t _{d(on)}	Turn-On Delay Time	V _{CC} = 600V, I _C = 15A, R _G = 15Ω, V _{GE} = 15V, Resistive Load, T _C = 25°C	-	33	-	ns
t _r	Rise Time		-	80	-	ns
t _{d(off)}	Turn-Off Delay Time		-	160	-	ns
t _f	Fall Time		-	255	330	ns
E _{on}	Turn-On Switching Loss		-	0.3	-	mJ
E _{off}	Turn-Off Switching Loss		-	0.58	0.74	mJ
E _{ts}	Total Switching Loss		-	0.88	-	mJ
t _{d(on)}	Turn-On Delay Time	V _{CC} = 600V, I _C = 15A, R _G = 15Ω, V _{GE} = 15V, Resistive Load, T _C = 125°C	-	30	-	ns
t _r	Rise Time		-	115	-	ns
t _{d(off)}	Turn-Off Delay Time		-	170	-	ns
t _f	Fall Time		-	390	-	ns
E _{on}	Turn-On Switching Loss		-	0.38	-	mJ
E _{off}	Turn-Off Switching Loss		-	0.89	-	mJ
E _{ts}	Total Switching Loss		-	1.27	-	mJ
Q _g	Total Gate Charge	V _{CE} = 600V, I _C = 15A, V _{GE} = 15V	-	100	-	nC
Q _{ge}	Gate to Emitter Charge		-	19	-	nC
Q _{gc}	Gate to Collector Charge		-	45	-	nC

Electrical Characteristics of the Diode $T_C = 25^\circ\text{C}$ unless otherwise noted

Symbol	Parameter	Test Conditions	Min.	Typ.	Max	Units	
V_{FM}	Diode Forward Voltage	$I_F = 15\text{A}$	$T_C = 25^\circ\text{C}$	-	1.4	1.8	V
			$T_C = 125^\circ\text{C}$	-	1.42	-	
t_{rr}	Diode Reverse Recovery Time	$I_{ES} = 15\text{A},$ $di/dt = 200\text{A}/\mu\text{s}$	$T_C = 25^\circ\text{C}$	-	575	-	ns
			$T_C = 125^\circ\text{C}$	-	577	-	
I_{rr}	Diode Peak Reverse Recovery Current	$I_{ES} = 15\text{A},$ $di/dt = 200\text{A}/\mu\text{s}$	$T_C = 25^\circ\text{C}$	-	30	-	A
			$T_C = 125^\circ\text{C}$	-	37	-	
Q_{rr}	Diode Reverse Recovery Charge	$I_{ES} = 15\text{A},$ $di/dt = 200\text{A}/\mu\text{s}$	$T_C = 25^\circ\text{C}$	-	8.7	-	μC
			$T_C = 125^\circ\text{C}$	-	10.7	-	

Typical Performance Characteristics

Figure 1. Typical Output Characteristics

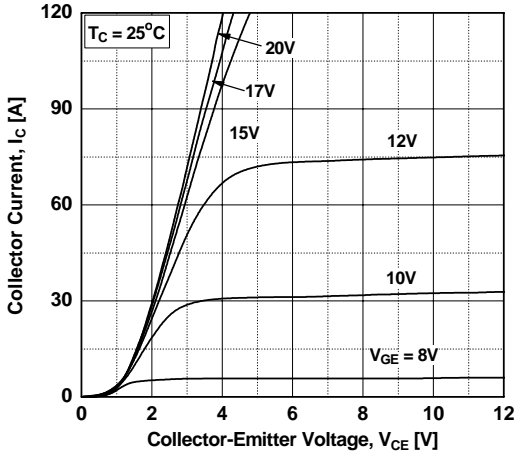

Figure 2. Typical Output Characteristics

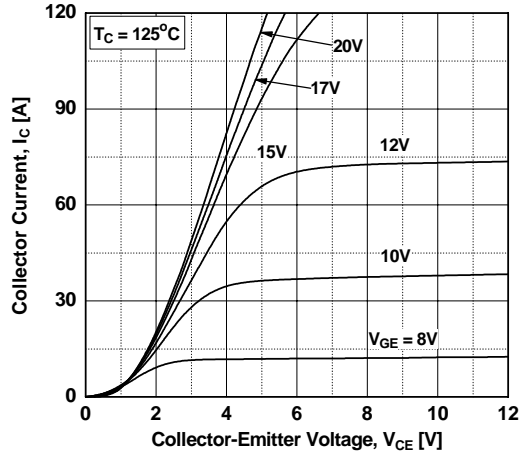

Figure 3. Typical Saturation Voltage Characteristics

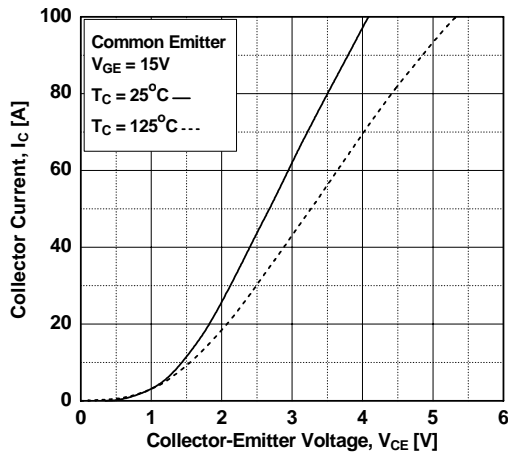

Figure 4. Transfer Characteristics

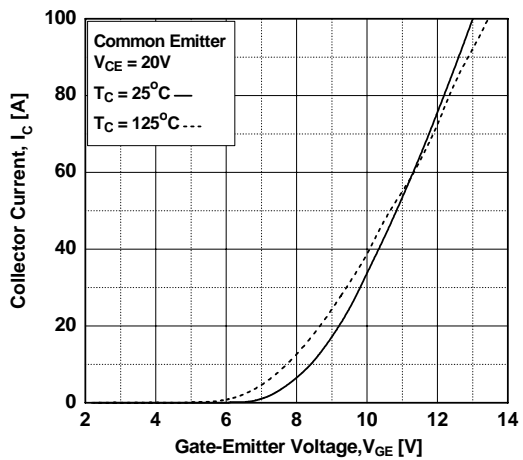

Figure 5. Saturation Voltage vs. Case Temperature at Variant Current Level

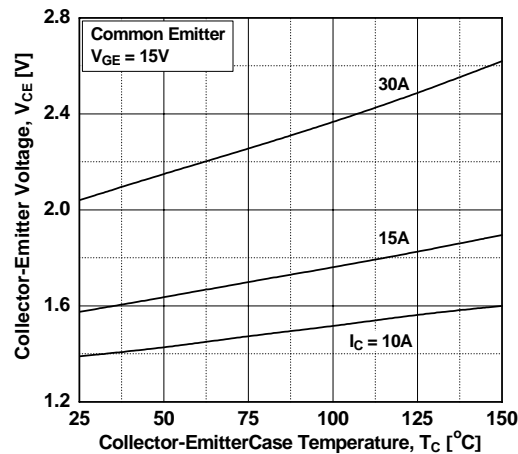
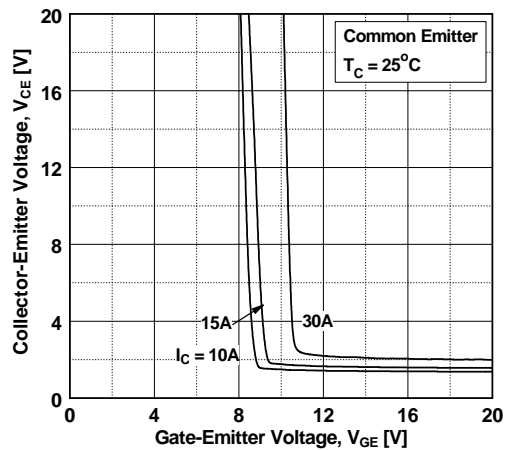

Figure 6. Saturation Voltage vs. V_{GE}



Typical Performance Characteristics

Figure 7. Saturation Voltage vs. V_{GE}

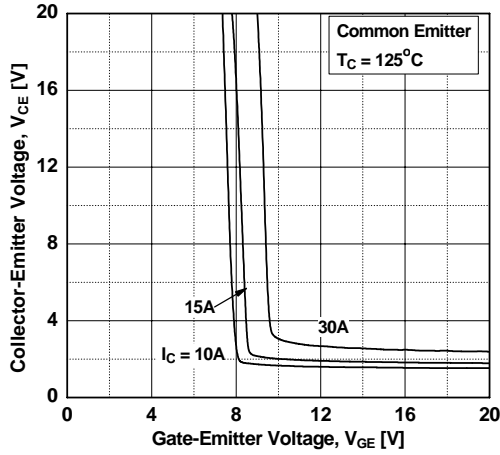

Figure 8. Capacitance Characteristics

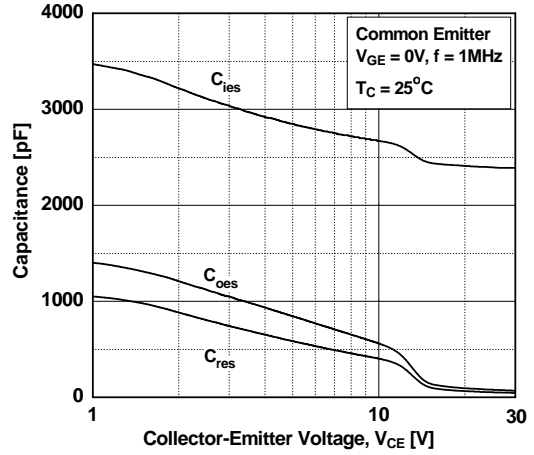

Figure 9. Gate charge Characteristics

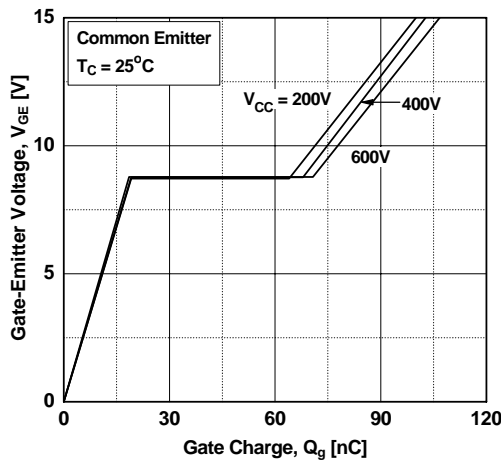

Figure 10. SOA Characteristics

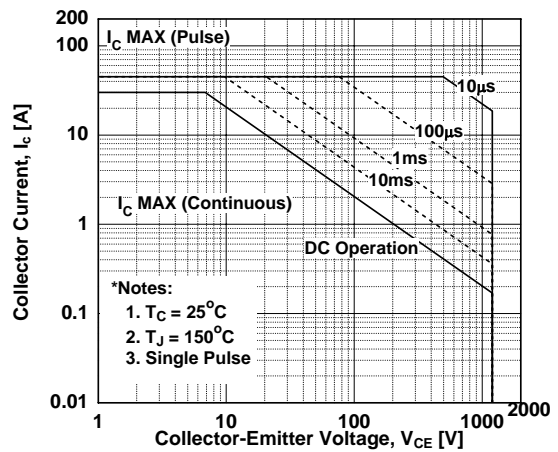

Figure 11. Turn-on Characteristics vs. Gate Resistance

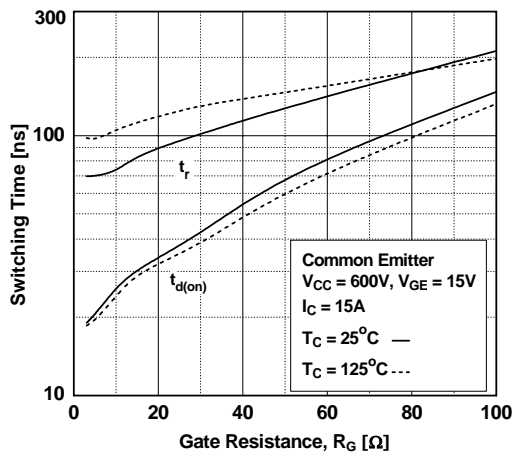
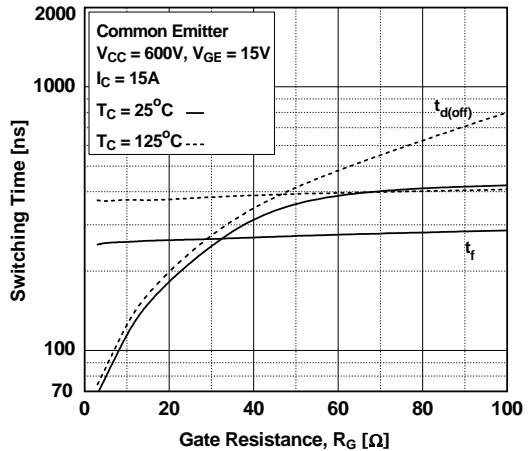

Figure 12. Turn-off Characteristics vs. Gate Resistance



Typical Performance Characteristics

Figure 13. Turn-on Characteristics vs. Collector Current

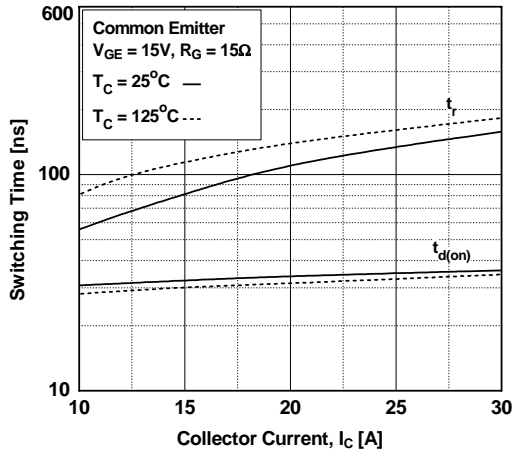

Figure 14. Turn-off Characteristics vs. Collector Current

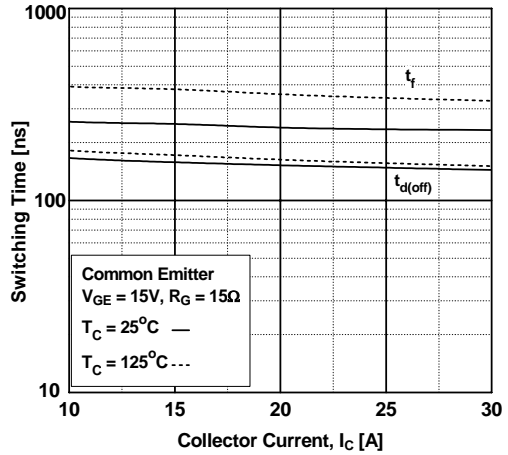

Figure 15. Switching Loss vs. Gate Resistance

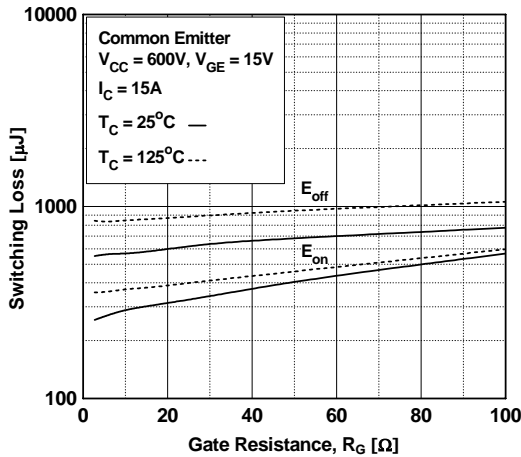

Figure 16. Switching Loss vs. Collector Current

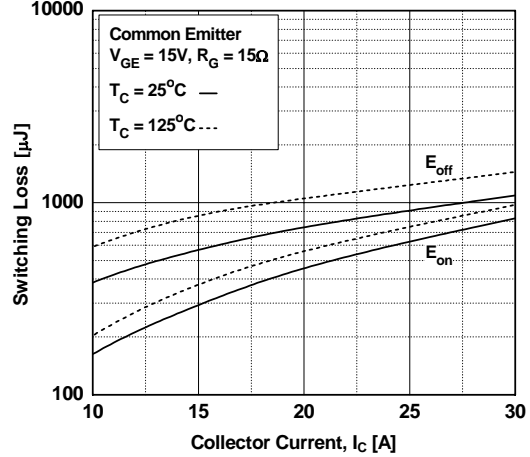

Figure 17. Turn off Switching SOA Characteristics

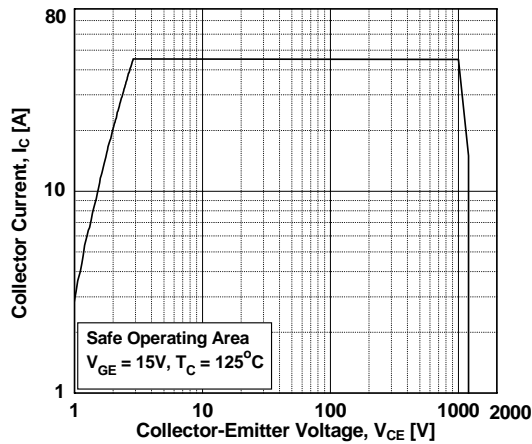
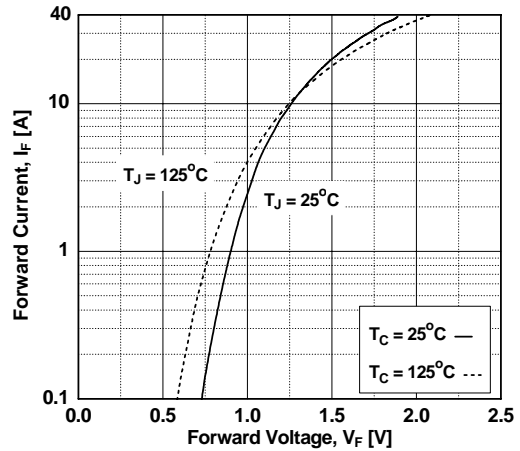

Figure 18. Forward Characteristics



Typical Performance Characteristics

Figure 19. Reverse Recovery Current

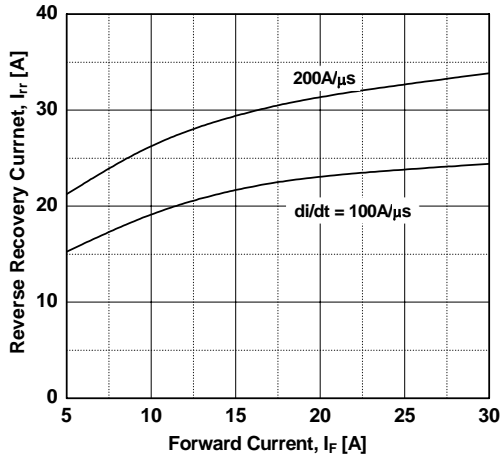

Figure 20. Stored Charge

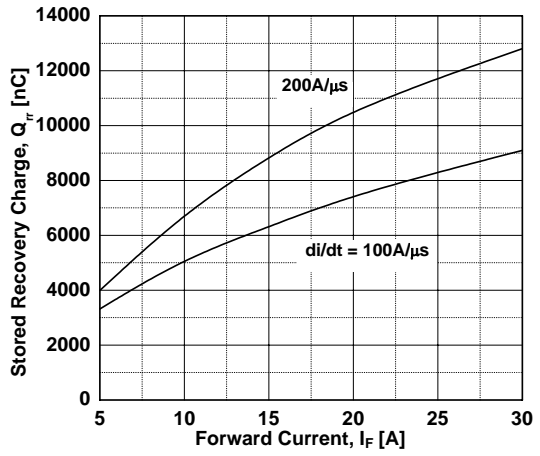

Figure 21. Reverse Recovery Time

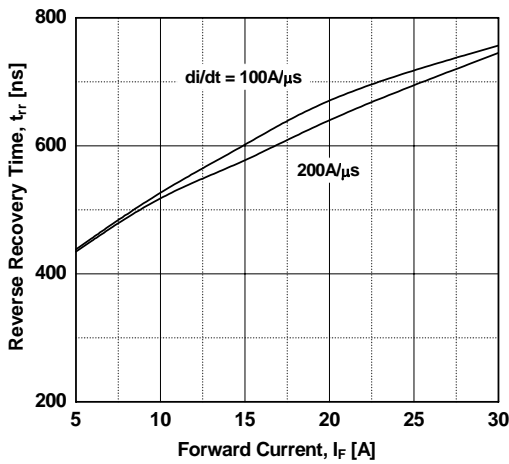
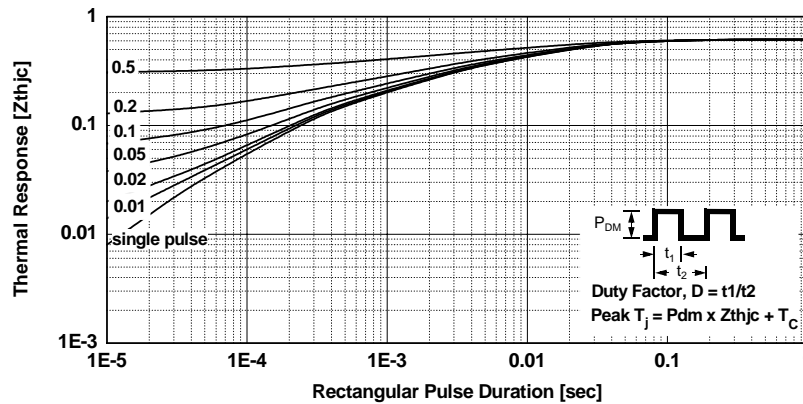
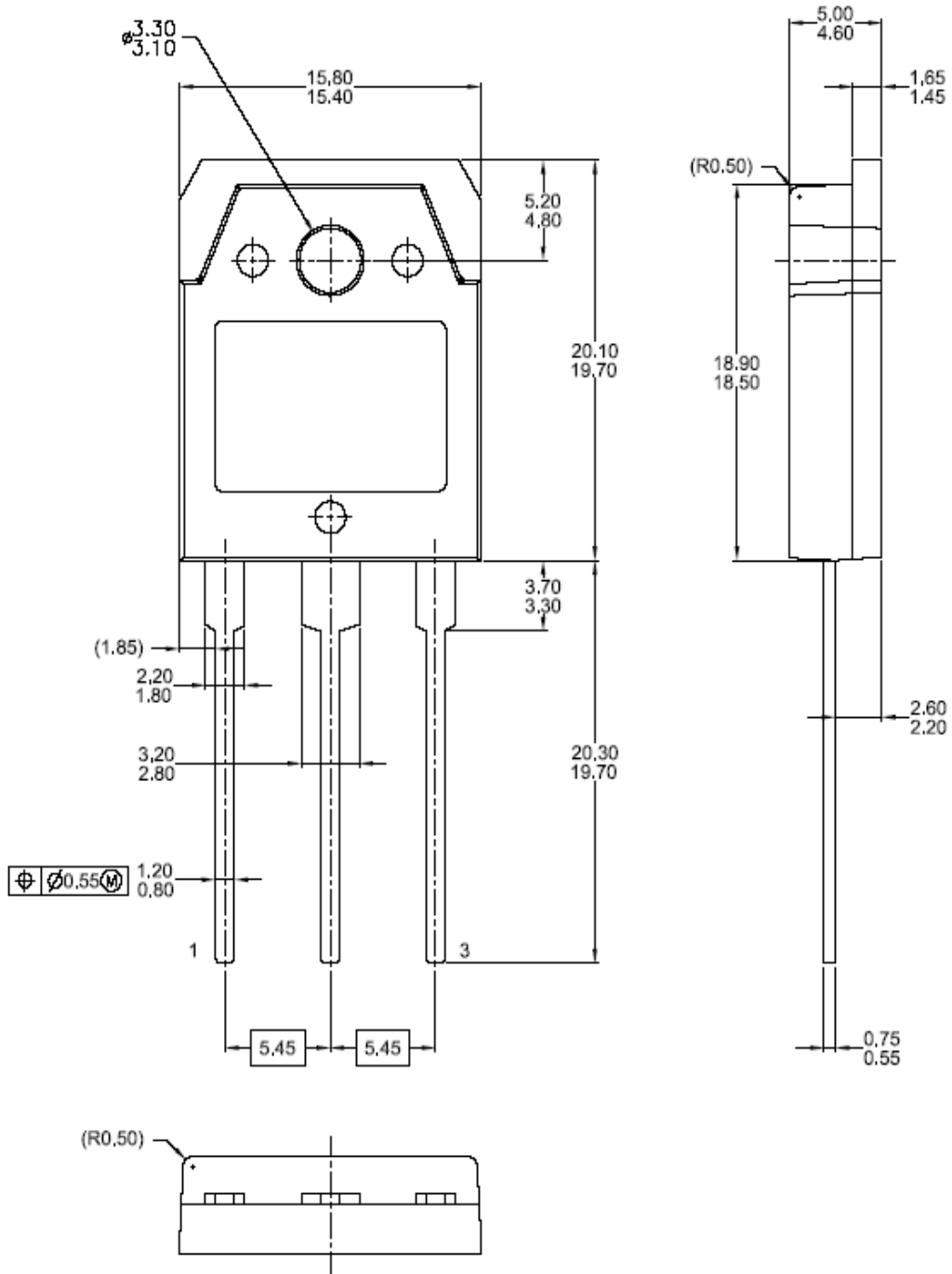

Figure 22. Transient Thermal Impedance of IGBT



Mechanical Dimensions

TO-3PN







Dimensions in Millimeters

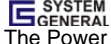

TRADEMARKS

The following includes registered and unregistered trademarks and service marks, owned by Fairchild Semiconductor and/or its global subsidiaries, and is not intended to be an exhaustive list of all such trademarks.

ACEx®	FPS™	PDP-SPM™	SupreMOS™
Build it Now™	FRFET®	Power220®	SyncFET™
CorePLUS™	Global Power Resource SM	POWEREDGE®	 SYSTEM GENERAL®
CROSSVOLT™	Green FPS™	Power-SPM™	The Power Franchise®
CTL™	Green FPS™ e-Series™	PowerTrench®	the power franchise
Current Transfer Logic™	GTO™	Programmable Active Droop™	TinyBoost™
EcoSPARK®	<i>i-Lo</i> ™	QFET®	TinyBuck™
EZSWITCH™ *	IntelliMAX™	QS™	TinyLogic®
 ™	ISOPLANAR™	QT Optoelectronics™	TINYOPTO™
 ™	MegaBuck™	Quiet Series™	TinyPower™
Fairchild®	MICROCOUPLER™	RapidConfigure™	TinyPWM™
Fairchild Semiconductor®	MicroFET™	SMART START™	TinyWire™
FACT Quiet Series™	MicroPak™	SPM®	µSerDes™
FACT®	MillerDrive™	STEALTH™	UHC®
FAST®	Motion-SPM™	SuperFET™	Ultra FRFET™
FastvCore™	OPTOLOGIC®	SuperSOT™-3	UniFET™
FlashWriter® *	OPTOPLANAR®	SuperSOT™-6	VCX™
	 ®	SuperSOT™-8	

* EZSWITCH™ and FlashWriter® are trademarks of System General Corporation, used under license by Fairchild Semiconductor.

DISCLAIMER

FAIRCHILD SEMICONDUCTOR RESERVES THE RIGHT TO MAKE CHANGES WITHOUT NOTICE TO ANY PRODUCTS HEREIN TO IMPROVE RELIABILITY, FUNCTION, OR DESIGN. FAIRCHILD DOES NOT ASSUME ANY LIABILITY ARISING OUT OF THE APPLICATION OR USE OF ANY PRODUCT OR CIRCUIT DESCRIBED HEREIN; NEITHER DOES IT CONVEY ANY LICENSE UNDER ITS PATENT RIGHTS, NOR THE RIGHTS OF OTHERS. THESE SPECIFICATIONS DO NOT EXPAND THE TERMS OF FAIRCHILD'S WORLDWIDE TERMS AND CONDITIONS, SPECIFICALLY THE WARRANTY THEREIN, WHICH COVERS THESE PRODUCTS.

LIFE SUPPORT POLICY

FAIRCHILD'S PRODUCTS ARE NOT AUTHORIZED FOR USE AS CRITICAL COMPONENTS IN LIFE SUPPORT DEVICES OR SYSTEMS WITHOUT THE EXPRESS WRITTEN APPROVAL OF FAIRCHILD SEMICONDUCTOR CORPORATION.

As used herein:

- Life support devices or systems are devices or systems which, (a) are intended for surgical implant into the body or (b) support or sustain life, and (c) whose failure to perform when properly used in accordance with instructions for use provided in the labeling, can be reasonably expected to result in a significant injury to the user.
- A critical component in any component of a life support, device or system whose failure to perform can be reasonably expected to cause the failure of the life support device or system, or to affect its safety or effectiveness.

PRODUCT STATUS DEFINITIONS

Definition of Terms

Datasheet Identification	Product Status	Definition
Advance Information	Formative or In Design	This datasheet contains the design specifications for product development. Specifications may change in any manner without notice.
Preliminary	First Production	This datasheet contains preliminary data; supplementary data will be published at a later date. Fairchild Semiconductor reserves the right to make changes at any time without notice to improve design.
No Identification Needed	Full Production	This datasheet contains final specifications. Fairchild Semiconductor reserves the right to make changes at any time without notice to improve design.
Obsolete	Not In Production	This datasheet contains specifications on a product that has been discontinued by Fairchild Semiconductor. The datasheet is printed for reference information only.

Rev. I33