

Agilent HLMP-Cxxx T-1^{3/4} (5 mm) Super Bright Precision Optical Performance InGaN LED Lamps Data Sheet

**HLMP-CB18, HLMP-CB19, HLMP-CM18, HLMP-CM19, HLMP-CE18,
HLMP-CE19, HLMP-CB28, HLMP-CB29, HLMP-CM28, HLMP-CM29,
HLMP-CE28, HLMP-CE29, HLMP-CB38, HLMP-CB39, HLMP-CM38,
HLMP-CM39, HLMP-CE38, HLMP-CE39**

Description

These Super Bright Precision Optical Performance LED lamps are based on flip chip InGaN material, which is the brightest and most efficient technology for LEDs in the blue, green, and cyan region of the spectrum. The 470 nm typical dominant wavelength for blue and 530 nm typical wavelength for green is well suited to color mixing in full color signs. The 500 nm typical dominant wavelength for cyan is suitable for traffic signal application.

These LED lamps are untinted, non-diffused, T-1^{3/4} packages incorporating second generation

optics producing well defined spatial radiation patterns at specific viewing cone angles.

These lamps are made with an advanced optical grade epoxy, offering superior temperature and moisture resistance in outdoor signal and sign applications. The high maximum LED junction temperature limit of +130°C enables high temperature operation in bright sunlight conditions. The package epoxy contains both UV-a and UV-b inhibitors to reduce the effects of long-term exposure to direct sunlight.

Features

- Well defined spatial radiation pattern
- High luminous output
- Available in blue green and cyan color
- Viewing angle: 15°, 23° and 30°
- Standoff or non-standoff leads
- Superior resistance to moisture
- New InGaN flip chip die technology with protective diode
- ESD class 3

Applications

- Traffic signals
- Commercial outdoor advertising
- Front panel backlighting
- Front panel indicators



Package Dimensions

PACKAGE DIMENSION A

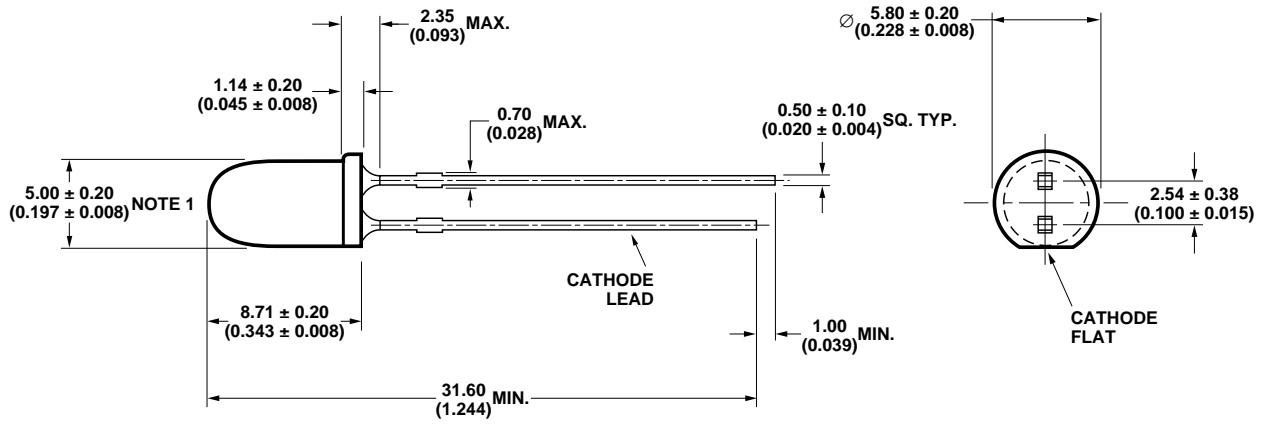

PACKAGE DIMENSION B

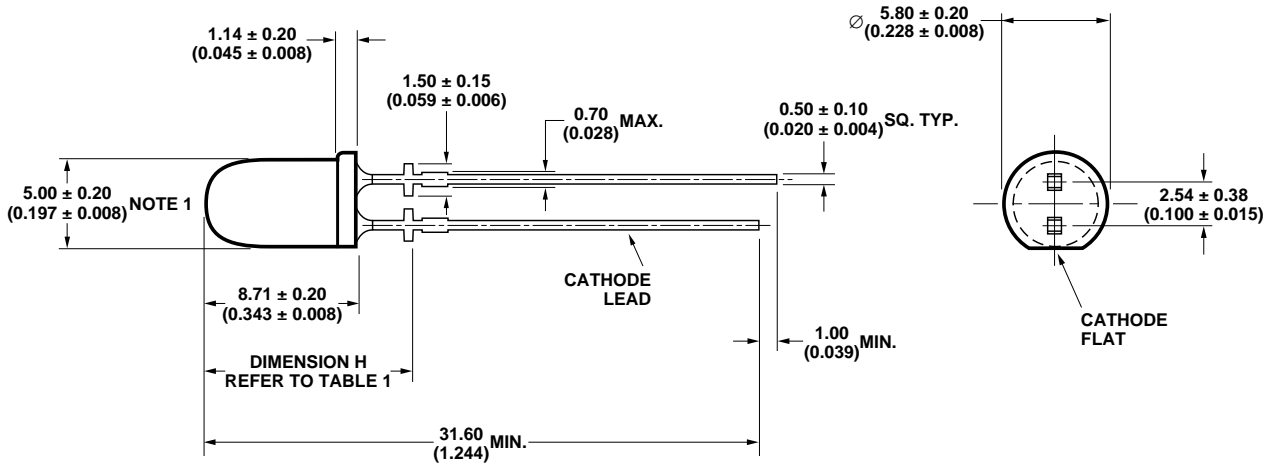

NOTES:

- 1. MEASURED JUST ABOVE FLANGE.
- 2. DIMENSIONS IN MILLIMETERS (INCHES).

DIMENSION H:	
23 & 30 DEGREE	= 12.67 ± 0.25 mm (0.499 ± 0.01 INCH)
15 DEGREE	= 12.93 ± 0.25 mm (0.509 ± 0.01 INCH)

Device Selection Guide

Part Number	Color	Typical Viewing Angle (Degree)	Intensity (cd) at 20 mA			Standoff	Package Dimension
			Min.	Typ.	Max.		
HLMP-CB18-TW0xx	Blue	15	2.50	3.50	7.20	No	A
HLMP-CB19-TW0xx	Blue	15	2.50	3.50	7.20	Yes	B
HLMP-CM18-X10xx	Green	15	7.20	12.0	21.0	No	A
HLMP-CM19-X10xx	Green	15	7.20	12.0	21.0	Yes	B
HLMP-CE18-WZ0xx	Cyan	15	5.50	11.8	16.0	No	A
HLMP-CE19-WZ0xx	Cyan	15	5.50	11.8	16.0	Yes	B
HLMP-CB28-RU0xx	Blue	23	1.50	2.40	4.20	No	A
HLMP-CB29-RU0xx	Blue	23	1.50	2.40	4.20	Yes	B
HLMP-CM28-WZ0xx	Green	23	5.50	9.30	16.0	No	A
HLMP-CM29-WZ0xx	Green	23	5.50	9.30	16.0	Yes	B
HLMP-CE28-VY0xx	Cyan	23	4.20	7.40	12.0	No	A
HLMP-CE29-VY0xx	Cyan	23	4.20	7.40	12.0	Yes	B
HLMP-CB38-QT0xx	Blue	30	1.15	1.50	3.20	No	A
HLMP-CB39-QT0xx	Blue	30	1.15	1.50	3.20	Yes	B
HLMP-CM38-UX0xx	Green	30	3.20	5.00	9.30	No	A
HLMP-CM39-UX0xx	Green	30	3.20	5.00	9.30	Yes	B
HLMP-CE38-TW0xx	Cyan	30	2.50	3.90	7.20	No	A
HLMP-CE39-TW0xx	Cyan	30	2.50	3.90	7.20	Yes	B

Notes:

1. Tolerance for luminous intensity measurement is $\pm 15\%$.
2. The luminous intensity is measured on the mechanical axis of the lamp package.
3. The optical axis is closely aligned with the package mechanical axis.
4. LED light output is bright enough to cause injuries to the eyes. Precautions must be taken to prevent looking directly at the LED with unaided eyes.

Ordering Information

HLMP - **x** **x** **xx** - **x** **x** **x** **xx**

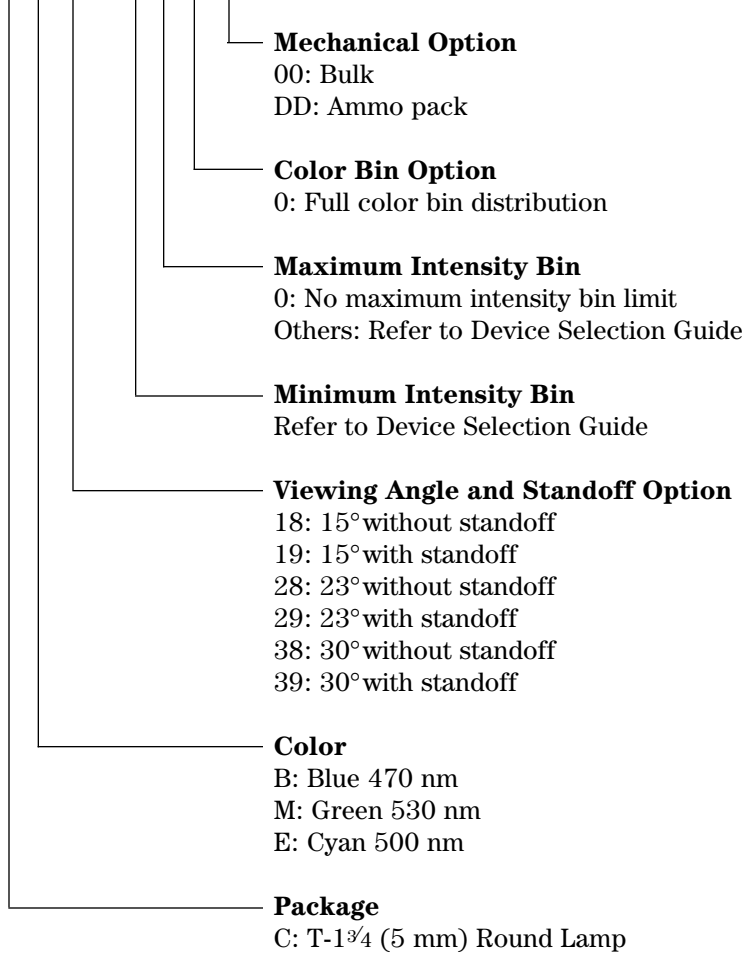

Mechanical Option

00: Bulk
DD: Ammo pack

Color Bin Option

0: Full color bin distribution

Maximum Intensity Bin

0: No maximum intensity bin limit
Others: Refer to Device Selection Guide

Minimum Intensity Bin

Refer to Device Selection Guide

Viewing Angle and Standoff Option

18: 15° without standoff
19: 15° with standoff
28: 23° without standoff
29: 23° with standoff
38: 30° without standoff
39: 30° with standoff

Color

B: Blue 470 nm
M: Green 530 nm
E: Cyan 500 nm

Package

C: T-1^{3/4} (5 mm) Round Lamp

Absolute Maximum Ratings at T_A = 25°C

Parameter	Value	Unit
DC Forward Current ^[1]	30	mA
Peak Pulsed Forward Current ^[2]	100	mA
Average Forward Current	30	mA
Power Dissipation	120	mW
LED Junction Temperature	130	°C
Operating Temperature Range	-40 to +85	°C
Storage Temperature Range	-40 to +100	°C
TTW Soldering Temperature ^[3]	250 for 5 secs	°C
Solder Dipping Temperature ^[3]	260 for 5 secs	°C

Notes:

1. Derate linearly as shown in Figure 3.
2. Duty factor 30%, 1KHz.
3. 1.59 mm (0.060 inch) above seating plane.

Electrical Characteristics at T_A = 25°C

Parameters	Symbol	Blue			Green			Cyan			Units	Test Condition
		Min.	Typ.	Max.	Min.	Typ.	Max.	Min.	Typ.	Max.		
Forward Voltage	V _F	3.4	4.0		3.2	4.0		3.3	4.0		V	I _F = 20 mA
Capacitance	C	53			53			53			pF	V _F = 0, f = 1 MHz
Viewing Angle ^[1]												
Cx18/Cx19	2θ _{1/2}	15			15			15			Deg	I _F = 20 mA
Cx28/Cx29		23			23			23				
Cx38/Cx39		30			30			30				
Reverse Voltage ^[2]	V _R	0.6			0.6			0.6			V	I _R = 10 μA
Thermal Resistance	Rθ _{J-PIN}	240			240			240			°C/W	LED Junction to cathode lead
Dominant Wavelength ^[3]	λ _d	460	470	480	520	530	540	490	500	510	nm	I _F = 20 mA
Peak Wavelength	λ _{PEAK}	466			523			495			nm	Peak of wavelength of spectral distribution at I _F = 20 mA
Spectral Half Width	Δλ _{1/2}	21			30			26				Wavelength width at spectral distribution power point at I _F = 20 mA
Luminous Efficacy ^[4]	η _v	62			588			220			lm/W	Emitted luminous power/Emitted radiant power

Notes:

1. 2θ_{1/2} is the off-axis angle where the luminous intensity is 1/2 the on axis intensity.
2. The reverse voltage of the product is equivalent to the forward voltage of the protective chip at I_R = 10 μA.
3. The dominant wavelength, λ_d, is derived from the Chromaticity Diagram and represents the color pf the lamp.
4. The radiant intensity, I_e in watts/steradian, may be found from the equation I_e = I_v/η_v, where I_v is the luminous intensity in candelas and η_v is the luminous efficacy in lumens/watt.

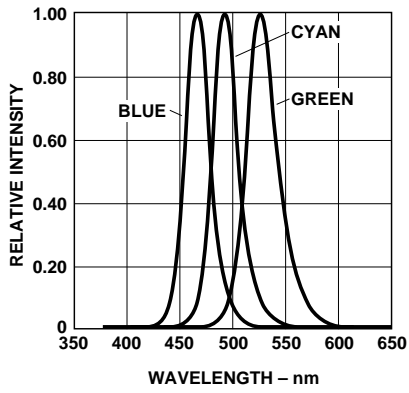

Figure 1. Relative intensity vs. wavelength.

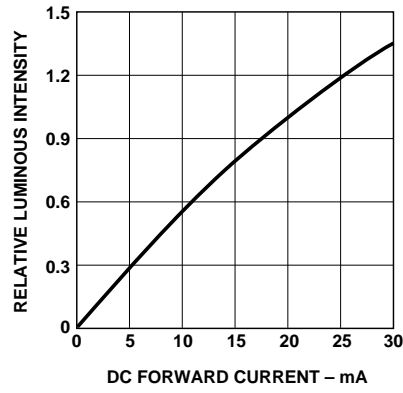

Figure 2. Relative luminous intensity vs. forward current.

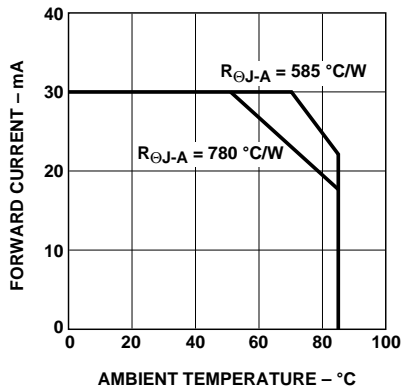

Figure 3. Forward current vs. ambient temperature.

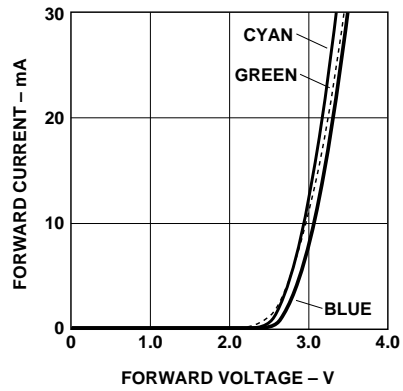

Figure 4. Forward current vs. forward voltage.

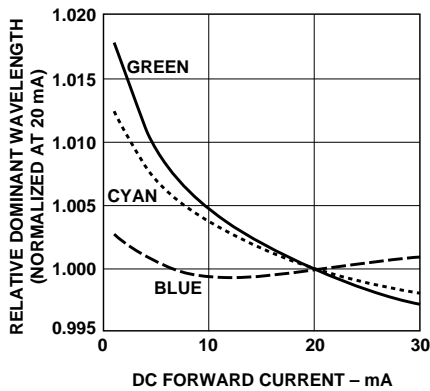

Figure 5. Relative dominant wavelength vs DC forward current.

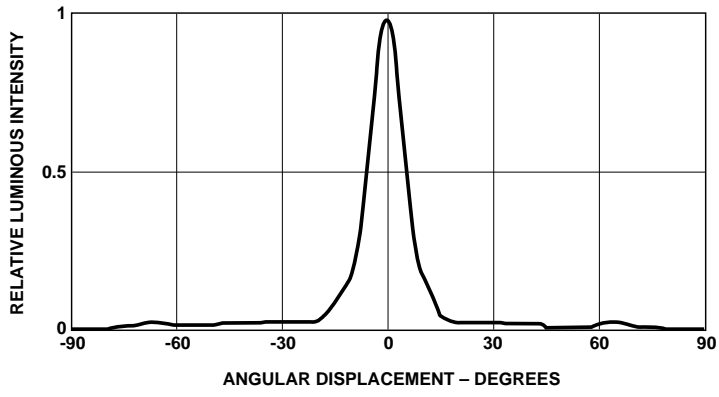

Figure 6. Spatial radiation pattern – 15 degree lamps.

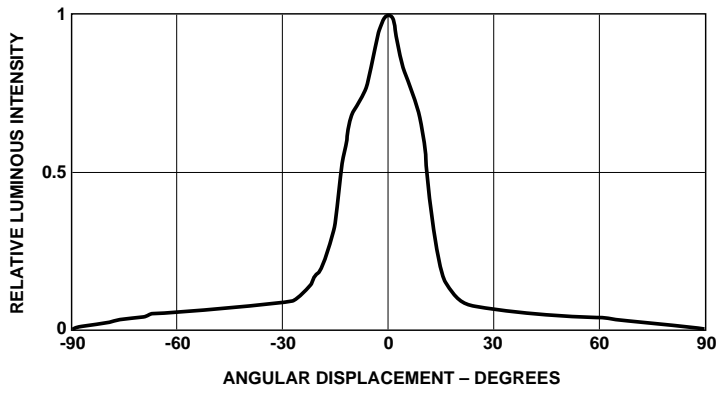

Figure 7. Spatial radiation pattern – 23 degree lamps.

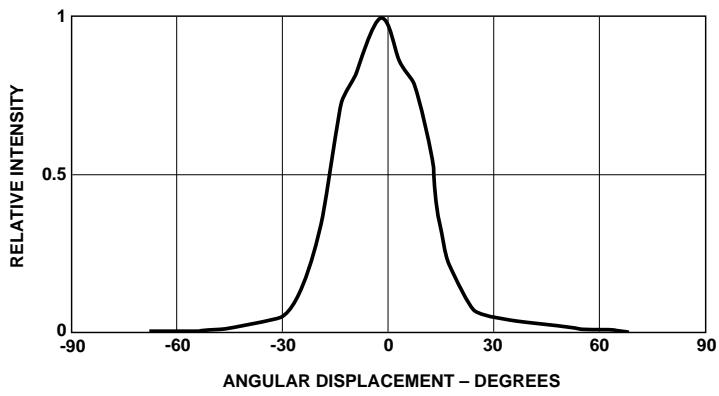

Figure 8. Spatial radiation pattern – 30 degree lamps.

Intensity Bin Limit Table

Bin	Intensity (mcd) at 20 mA	
	Min	Max
N	680	880
P	880	1150
Q	1150	1500
R	1500	1900
S	1900	2500
T	2500	3200
U	3200	4200
V	4200	5500
W	5500	7200
X	7200	9300
Y	9300	12000
Z	12000	16000
1	16000	21000

Tolerance for each bin limit is $\pm 15\%$.

Blue Color Bin Table

Bin	Min. Dom	Max. Dom	Xmin.	Ymin.	Xmax.	Ymax.
1	460.0	464.0	0.1440	0.0297	0.1766	0.0966
			0.1818	0.0904	0.1374	0.0374
2	464.0	468.0	0.1374	0.0374	0.1699	0.1062
			0.1766	0.0966	0.1291	0.0495
3	468.0	472.0	0.1291	0.0495	0.1616	0.1209
			0.1699	0.1062	0.1187	0.0671
4	472.0	476.0	0.1187	0.0671	0.1517	0.1423
			0.1616	0.1209	0.1063	0.0945
5	476.0	480.0	0.1063	0.0945	0.1397	0.1728
			0.1517	0.1423	0.0913	0.1327

Tolerance for each bin limit is ± 0.5 nm.

Green Color Bin Table

Bin	Min. Dom	Max. Dom	Xmin.	Ymin.	Xmax.	Ymax.
1	520.0	524.0	0.0743	0.8338	0.1856	0.6556
			0.1650	0.6586	0.1060	0.8292
2	524.0	528.0	0.1060	0.8292	0.2068	0.6463
			0.1856	0.6556	0.1387	0.8148
3	528.0	532.0	0.1387	0.8148	0.2273	0.6344
			0.2068	0.6463	0.1702	0.7965
4	532.0	536.0	0.1702	0.7965	0.2469	0.6213
			0.2273	0.6344	0.2003	0.7764
5	536.0	540.0	0.2003	0.7764	0.2659	0.6070
			0.2469	0.6213	0.2296	0.7543

Tolerance for each bin limit is ± 0.5 nm.

Cyan Color Bin Table

Bin	Min. Dom	Max. Dom	Xmin.	Ymin.	Xmax.	Ymax.
3	500.0	505.0	0.0082	0.5384	0.1027	0.5584
			0.1057	0.4769	0.0039	0.6548
4	505.0	510.0	0.0039	0.6548	0.1097	0.6251
			0.1027	0.5584	0.0139	0.7502
7	498.0	503.0	0.0132	0.4882	0.1028	0.5273
			0.1092	0.4417	0.0040	0.6104
8	503.0	508.0	0.0040	0.6104	0.1056	0.6007
			0.1028	0.5273	0.0080	0.7153

Tolerance for each bin limit is ± 0.5 nm.

www.agilent.com/semiconductors

For product information and a complete list of distributors, please go to our web site.

For technical assistance call:

Americas/Canada: +1 (800) 235-0312 or (408) 654-8675

Europe: +49 (0) 6441 92460

China: 10800 650 0017

Hong Kong: (+65) 6756 2394

India, Australia, New Zealand: (+65) 6755 1939

Japan: (+81 3) 3335-8152(Domestic/International), or 0120-61-1280(Domestic Only)

Korea: (+65) 6755 1989

Singapore, Malaysia, Vietnam, Thailand, Philippines, Indonesia: (+65) 6755 2044

Taiwan: (+65) 6755 1843

Data subject to change.

Copyright © 2003 Agilent Technologies, Inc.

April 10, 2003

5988-9268EN



Agilent Technologies