

LR001
LR001-01
IL00

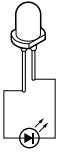

LR010
LR010-02
IL00

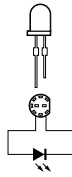

LR002
LR002-01
IL00

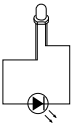

LR013
LR013-01
IL00

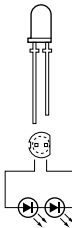

LR003
LR003-01
IL00

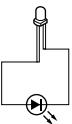

LR014
LR014-02
IL00

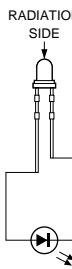

LR006
LR006-01
IL00

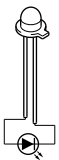

LR015
LR015-02
IL08

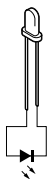

LR008
LR008-01
IL00



LR017

LR017-01
IL00

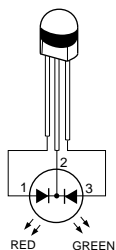

LR017-02
IL00

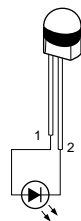

LR023

LR023-01
IL00



LR018

LR018-02
IL00

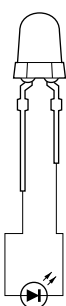

LR024

LR024-01
IL00

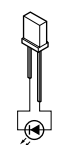

LR019

LR019-01
IL00

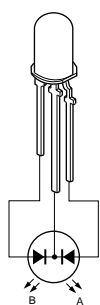

LR019-03
IL08

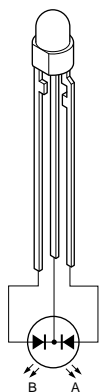

A : RED
B : GREEN

LR019-04
IL08

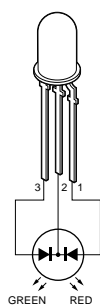

LR029

LR029-01
IL00



LR020

LR020-01
IL00

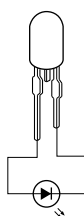

LR032

LR032-01
IL08

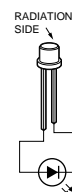

LR052

LR052-01
IL08

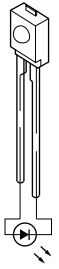

LR056

LR056-01
IL00

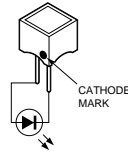

LR053

LR053-02
IL00

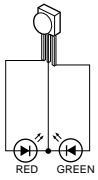

LR057

LR057-01
IL00

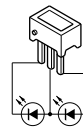

LR057-03
IL00

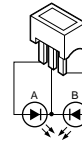

LR054

LR054-01
IL08

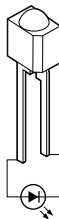

LR058

LR058-01
IL00

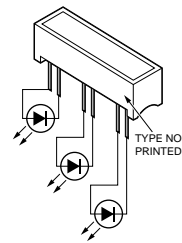

LR055

LR055-01
IL00

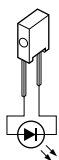

LR059

LR059-01
IL08

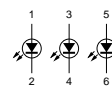
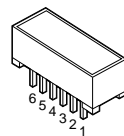

LR060

LR060-04
IL08

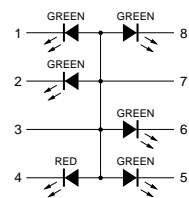
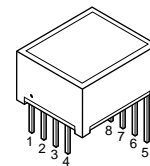

LR061

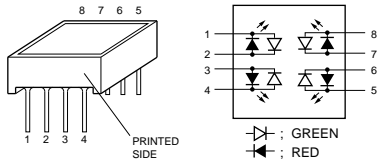

LR061-02
IL00

LR075

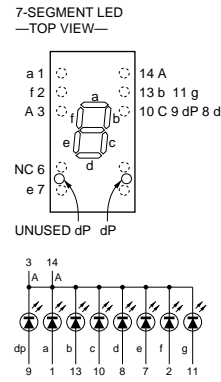

LR075-06
IL22

LR062

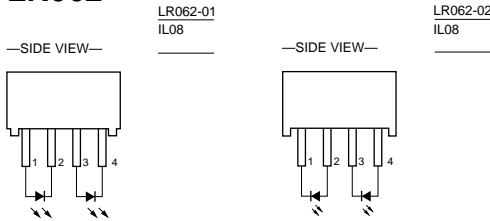

LR076

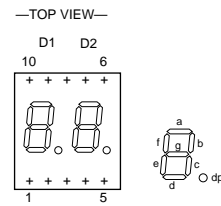

LR076-01
IL00

LR072

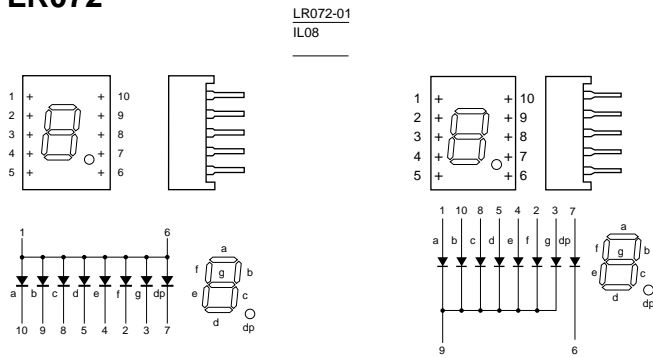

LR072-02
IL00

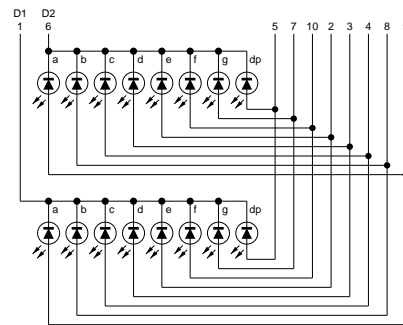

LR072-04
IL08

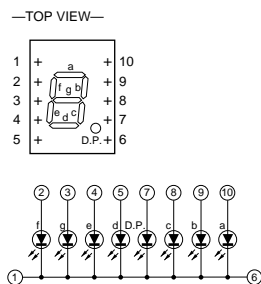

LR072-06
IL00

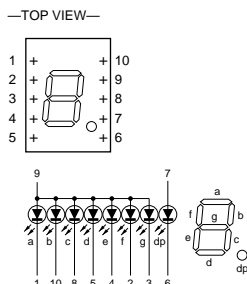

LR077

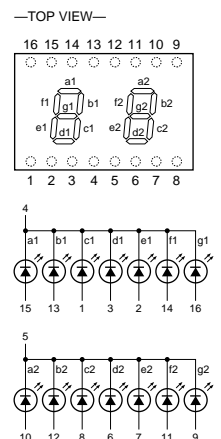

LR077-01
IL08

LR078

LR078-01
IL00

—TOP VIEW—

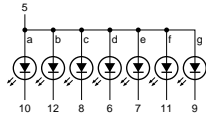
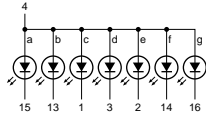
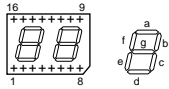

LR079

LR079-02
IL00

—TOP VIEW—

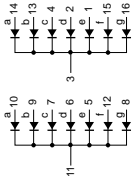
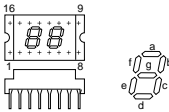

—TOP VIEW—

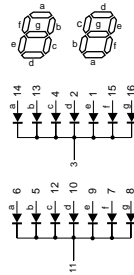
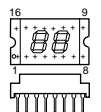

LR079-03
IL00

LR081

LR081-01
IL08

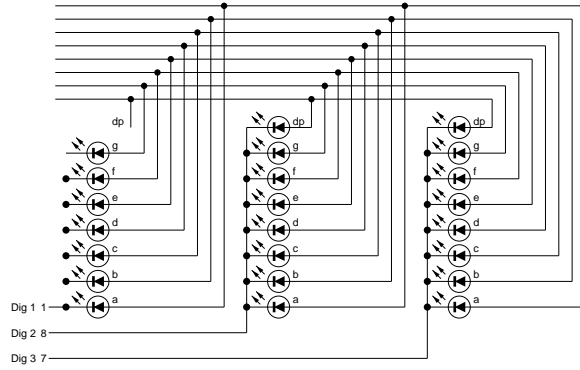
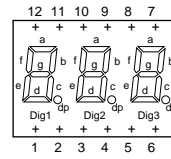

TRIPLE 7-SEGMENT LED
—TOP VIEW—

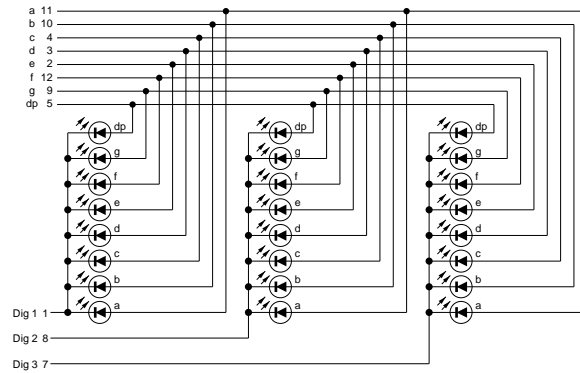
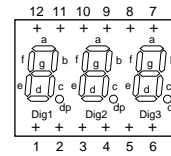

LR081-03
IL00

LR083

LR083-04
IL00

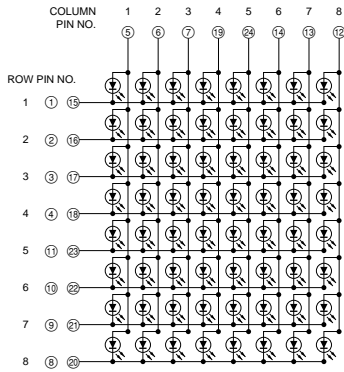
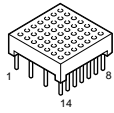

LR085

LR085-03
IL05

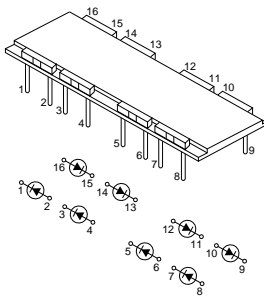

LR086

LR086-01
IL00

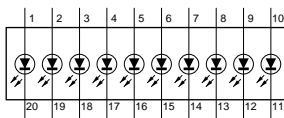
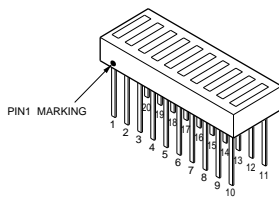

LR089

LR089-01
IL00

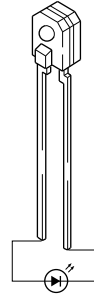

LR095

LR095-01
IL00

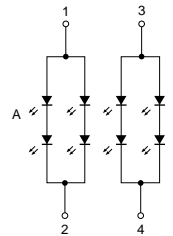
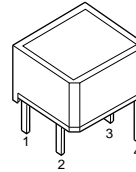

LR096

LR096-01
IL08

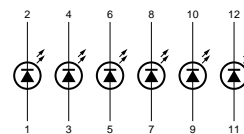
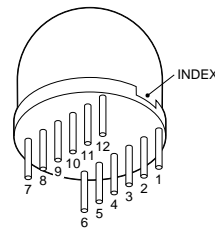

LR100

LR100-01
IL00

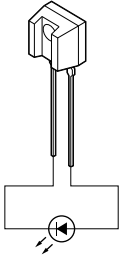

LR104

LR104-01(1/2)
IL08

C-MOS .145" 4-CHARACTER, DOT MATRIX
—TOP VIEW—

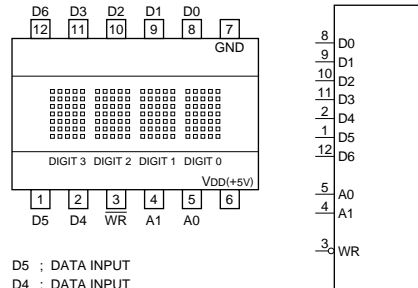

- D5 ; DATA INPUT
- D4 ; DATA INPUT
- WR ; WRITE
- A1 ; DIGIT SELCT
- A0 ; DIGIT SELCT
- D0 ; DATA INPUT(LSB)
- D1 ; DATA INPUT
- D2 ; DATA INPUT
- D3 ; DATA INPUT
- D6 ; DATA INPUT(MSB)

LR101

LR101-01
IL16

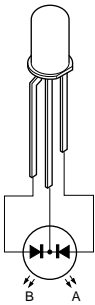

LR104-01(2/2)

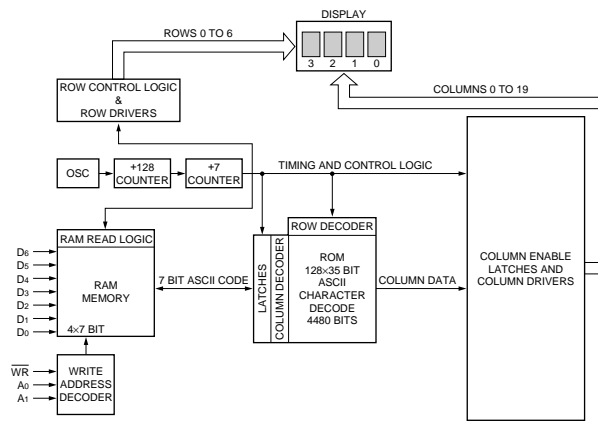

LR103

LR103-01
IL08

