

*ROHS COMPLIANT

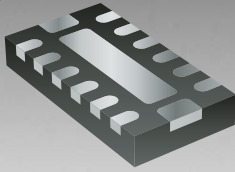

BOURNS®

Features

- Lead free as standard
- RoHS compliant*
- ESD protection >25 kV
- Protects up to 6 lines
- Bidirectional EMI filtering
- DFN-12 package

Applications

- Cell phones
- PDAs and notebooks
- GPS and SMART cards
- Color LCD display panel

2FAG-M12R Integrated Passive & Active Devices

General Information

The 2FAG-M12R device, manufactured using Thin Film on Silicon technology, provides ESD protection for the external ports of portable electronic devices such as cell phones, notebooks and PDAs.

The ESD protection provided by the component enables a data port to withstand a minimum ± 8 KV Contact / ± 15 KV Air Discharge per the ESD test method specified in IEC 61000-4-2. The device measures 3 mm x 1.4 mm and can be mounted directly onto an FR4 printed circuit board. The device meets typical thermal cycle and bend test specifications without the use of an underfill material.

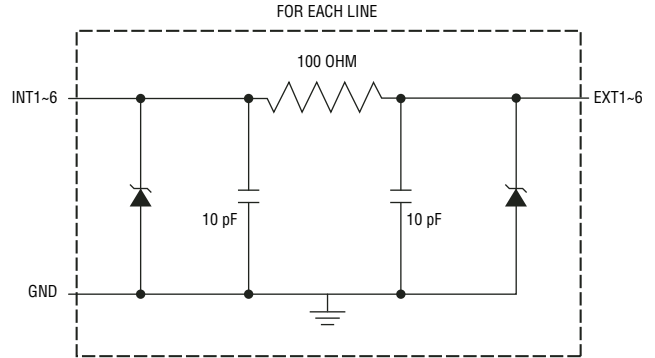

Electrical Characteristics (@ $T_A = 25^\circ\text{C}$ Unless Otherwise Noted)

Parameter	Symbol	Min.	Nom.	Max.	Unit
Resistance	R	80	100	120	Ω
Capacitance @ 2.5 V, 1 MHz	C	16	20	24	pF
Rated Standoff Voltage	V_{WM}			5	V
Breakdown Voltage @ 1 mA	V_{BR}	6			V
Forward Voltage @ 10 mA	V_F		0.8		V
Leakage Current @ 3 V	I_D			0.1	μA
ESD Protection: IEC 61000-4-2 Contact Discharge Air Discharge		± 8 ± 15			kV kV
Frequency: Attenuation @ 800-3000 MHz Cut-off (50 Ω I/O) Zero Bias	f_c	25	35 150		db MHz
DC Power per Resistor	P			100	mW

Thermal Characteristics (@ $T_A = 25^\circ\text{C}$ Unless Otherwise Noted)

Parameter	Symbol	Min.	Nom.	Max.	Unit
Operating Temperature Range	T_J	-40	+25	+85	$^\circ\text{C}$
Storage Temperature Range	T_{STG}	-55	+25	+150	$^\circ\text{C}$

2FAG-M12R Integrated Passive & Active Devices



Product Dimensions

This device consists of a DFN package. It consists of 12 I/O pins and 1 ground pin and has a flammability rating of UL 94V-0. The package measures 3 mm x 1.4 mm, weighs approximately 0.10 mg and has a 100 % Sn finish termination.

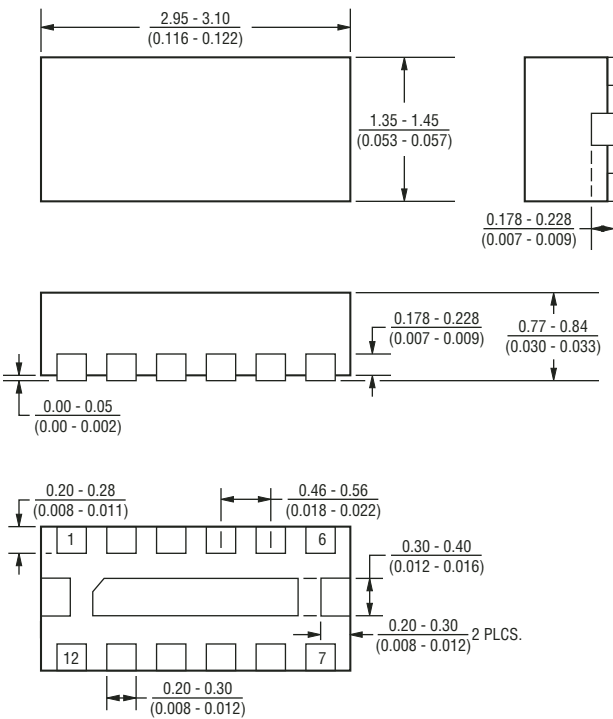

Recommended Pad Layout

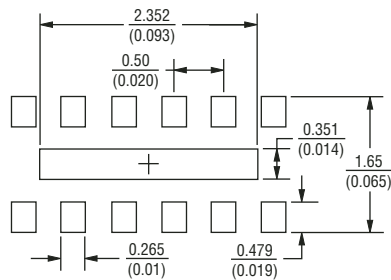

DIMENSIONS = $\frac{\text{MILLIMETERS}}{\text{(INCHES)}}$

Frequency Response

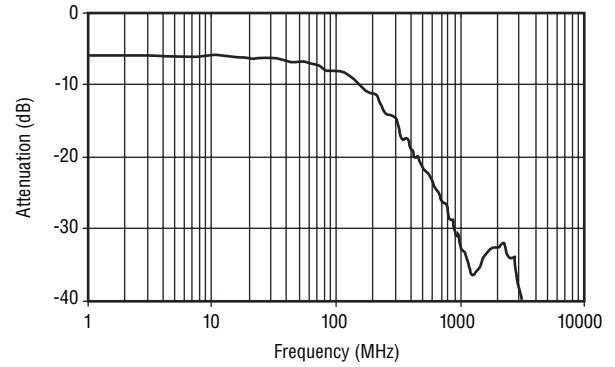

Block Diagram

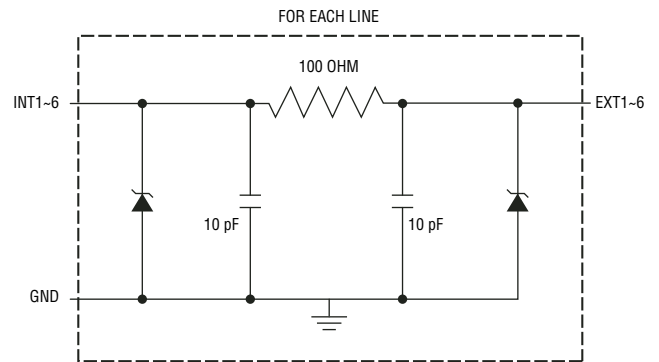

How to Order

2 FAG - M12R

Thinfilim _____
 Model _____
 Micro Leadframe _____
 Number of Pads _____
 Packaging Option _____
 R = Tape and Reel
 Packaged 3000 pcs. / 7" reel

Device Pin Out

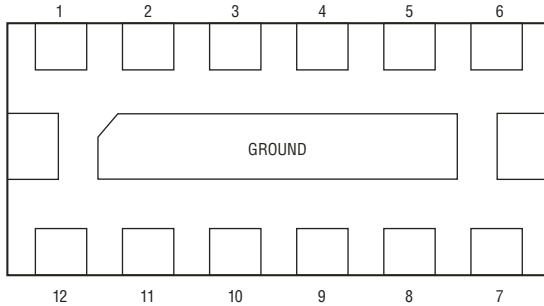

Pin	Function		Function
1	INT 1	7	EXT 6
2	INT 2	8	EXT 5
3	INT 3	9	EXT 4
4	INT 4	10	EXT 3
5	INT 5	11	EXT 2
6	INT 6	12	EXT 1

Packaging

The surface mount product is packaged in a 8 mm x 4 mm Tape and Reel format per EIA-481 standard.

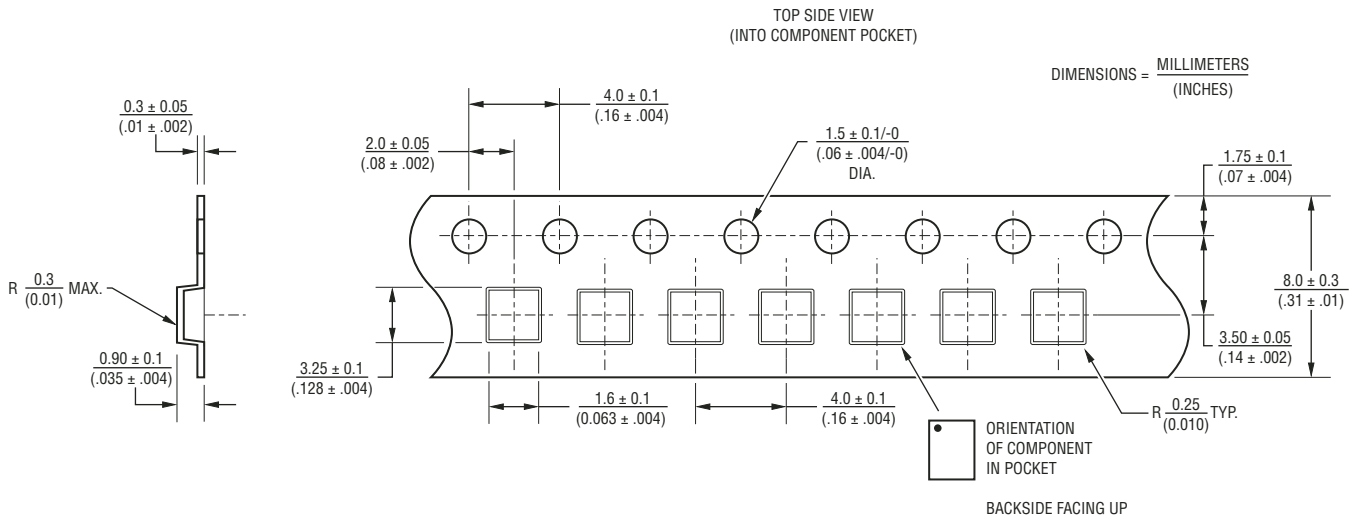

Reliable Electronic Solutions

Asia-Pacific: TEL +886- (0)2 25624117 • FAX +886- (0)2 25624116

Europe: TEL +41-41 768 5555 • FAX +41-41 768 5510

The Americas: TEL +1-951 781-5492 • FAX +1-951 781-5700

www.bourns.com