

# UTC TA31142 LINEAR INTEGRATED CIRCUIT

## LOW POWER IF RECEIVER IC

### DESCRIPTION

The UTC TA31142 is a low power IF receiver IC and is suitable for use as the second IF downconverter in double-conversion paging systems. It is well-suited for POCSAG paging applications and incorporates a 2-level FSK demodulator consisting of a quadrature FM demodulator, on-chip bit-rate filter, and 1-bit comparator. An on-chip 1V regulator is provided for convenient biasing of off-chip circuitry.

### FEATURES

- \*Extremely low power operation with power-down feature
- \*Built-in crystal oscillator for mixer local oscillator
- \*Mixer input frequency: 10-50 MHz
- \*Quadrature detector
- \*On-chip bit-rate filter
- \*Audio output
- \*1-bit comparator with open collector output
- \*1V regulator
- \*1.1V low battery alarm

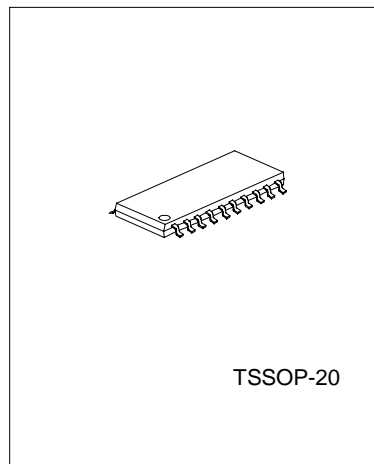

### PIN CONFIGURATIONS

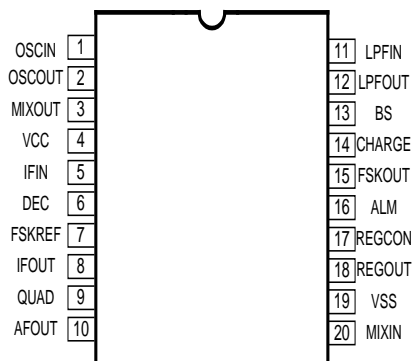

UTC UNISONIC TECHNOLOGIES CO., LTD. 1

QW-R103-015,A

## UTCTA31142 LINEAR INTEGRATED CIRCUIT

| NUMBER | SYMBOL | DESCRIPTION  | NUMBER | SYMBOL | DESCRIPTION  |
|--------|--------|--|--------|--------|--|
| 1      | OSCIN  | Oscillator input (base)  | 11     | LPFIN  | LPF operational amplifier input  |
| 2      | OSCOUT | Oscillator output (emitter)                                    | 12     | LPFOUT | LPF operational amplifier output   |
| 3      | MIXOUT | Mixer output (2K $\Omega$ output impedance)                    | 13     | BS     | Two-state logic input to control receiver power up/down. (BS=high=normal operation; BS=low=stand-by mode)    |
| 4      | VCC    | Nominal 1.4V supply  | 14     | CHARGE | Two-state logic input to control charge-discharge circuit. (CHARGE=high=fast charge; CHARGE=low=slow charge) |
| 5      | IFIN   | IF amplifier input (2K $\Omega$ input impedance)               | 15     | FSKOUT | Open collector NRZ comparator output (requires pull-up resistor)   |
| 6      | DEC    | IF amplifier de-coupling capacitor connection                  | 16     | ALM    | Open collector low battery alarm output (requires pull-up resistor)  |
| 7      | FSKREF | 1-bit comparator reference input (requires external capacitor) | 17     | BEGCON | 1.0V regulator control output for connection to external PNP base  |
| 8      | IFOUT  | IF amplifier output  | 18     | REGOUT | 1.0V regulator input for connection to external PNP collector  |
| 9      | QUAD   | Quadrature FM demodulator input                                | 19     | VSS    | Ground   |
| 10     | AFOUT  | Quadrature FM demodulator output                               | 20     | MIXIN  | Mixer input (5K $\Omega$ input impedance)  |

### ABSOLUTE MAXIMUM RATINGS (V<sub>SS</sub>=0V)

| PARAMETER                   | SYMBOL          | VALUE  | UNIT |
|-----------------------------|-----------------|--|------|
| Supply Voltage              | V <sub>CC</sub> | V <sub>SS</sub> -0.3 to V <sub>SS</sub> +3.5 | V    |
| Operating temperature range | TOPR            | -30 to 85                                    | °C   |
| Storage temperature range   | TSTG            | -55 to 150                                   | °C   |
| Soldering temperature range | TSLD            | 255  | °C   |
| Soldering time range        | tSLD            | 10   | s    |

### RECOMMENDED OPERATING CONDITIONS (V<sub>SS</sub>=0V)

| PARAMETER             | SYMBOL             | VALUE |      |      | UNIT |
|-----------------------|--------------------|-------|------|------|------|
|                       |                    | Min.  | Typ. | Max. |      |
| Supply voltage range  | V <sub>CC</sub>    | 1.1   | 1.35 | 1.6  | V    |
| MIXIN input frequency | f <sub>MIXIN</sub> |       |      | 50   | MHz  |
| Operating temperature | T <sub>A</sub>     | -10   | 25   | 60   | °C   |

## UTC TA31142 LINEAR INTEGRATED CIRCUIT

### ELECTRICAL CHARACTERISTICS (Ta=25°C, Vcc=1.4V, Vss=0V, BS=high unless otherwise noted)

| PARAMETER                                    | SYMBOL                  | TEST CONDITIONS                                     | MIN  | TYP  | MAX  | UNIT  |
|--|-------------------------|---|------|------|------|-------|
| Quiescent current consumption                | I <sub>CC,total</sub>   |   |      | 1.1  | 1.6  | mA    |
| Standby current consumption                  | I <sub>CC,modby</sub>   | V <sub>BS</sub> =0V                                 |      |      | 5    | μA    |
| Mixer conversion gain                        | G <sub>c</sub>          | Measured after 455 KHz ceramic filter               | 9    | 12.5 | 16   | dB    |
| Mixer output intermodulation intercept point | OIP3                    |   |      | -10  |      | dBm   |
| Mixer input resistance                       | R <sub>in,MIX</sub>     |   |      | 5    |      | kΩ    |
| Mixer output resistance                      | R <sub>out,MIX</sub>    |   |      | 2    |      | kΩ    |
| IF amplifier input resistance                | R <sub>in,IF</sub>      |   |      | 2    |      | kΩ    |
| S/N ratio 1                                  | SN1                     | -53 dBm at MIXIN                                    |      | 63   |      | dB    |
| S/N ratio 2                                  | SN2                     | -53 dBm at IFIN                                     |      | 63   |      | dB    |
| S/N ratio 3                                  | SN3                     | -91 dBm at IFIN                                     |      | 25   |      | dB    |
| Demodulation output level                    | VOD                     | -53 dBm at IFIN                                     |      | 45   |      | mVrms |
| AM rejection ratio                           | AMR                     | -53 dBm at IFIN AM=30%                              |      | 50   |      | dB    |
| FSK output duty ratio                        | DR                      |   | 40   | 50   | 60   | %     |
| Low battery alarm threshold voltage          | V <sub>ALM</sub>        |   | 1.05 | 1.1  | 1.15 | V     |
| Regulator output voltage                     | V <sub>REGOUT</sub>     | 430Ω load resistor                                  | 0.95 | 1.0  | 1.05 | V     |
| Charging / discharging current               | I <sub>CH</sub>         | V <sub>FSKREF</sub> =0V, V <sub>LPFOUT</sub> =0.18V | 35   | 70   | 110  | μA    |
| ALM logic HIGH output current                | I <sub>OH,ALM</sub>     |   |      |      | 2    | μA    |
| ALM logic LOW output voltage                 | I <sub>OL,ALM</sub>     |   |      |      | 0.4  | V     |
| FSKOUT logic HIGH output current             | I <sub>OH,FSK.OUT</sub> |   |      |      | 2    | μA    |
| FSKOUT logic LOW output voltage              | V <sub>OL,PSK,OUT</sub> |   |      |      | 0.4  | V     |

# UTC TA31142 LINEAR INTEGRATED CIRCUIT

---

## FUNCTIONAL DESCRIPTION

The UTC TA31142 IF receiver IC incorporates a mixer, crystal-based local oscillator, IF amplifier, quadrature FM demodulator, bit-rate filter, and 1-bit comparator and is capable of demodulating 2-level FSK input signals. In addition, 1.0V regulator and 1.1V low battery alarm functions are provided.

## POWER-DOWN FUNCTION

The entire receiver IC may be powered up and down through the control of the BS input (pin13). During power down operation, the quiescent current consumption of the IC drops to approximately 0 $\mu$ A. The high input impedance of the BS pin allows for direct interfacing with the CMOS output of an off-chip micro controller.

## CHARGE / DISCHARGE CIRCUITRY

The function of the charge / discharge circuitry is for both fast and slow charging / discharging of the capacitor used for storing the voltage reference level of the FSKREF pin. The CHARGE input (pin14) should be enabled (CHARGE=high=fast charge) immediately after transition of the receiver IC from power-down to normal operation in order to reduce the charging / discharging time for coarse adjustment of the FSKREF voltage to the appropriate dc level (i.e. dc level of LPFOUT pin) and consequently to minimize the erroneous output of the 1-bit comparator. During actual data reception, the CHARGE pin should be set to low (CHARGE=low=slow charge) for fine adjustment of the FSKREF voltage.

## 1-bit COMPARATOR

The integrated 1-bit comparator operates as a data slicer and "squares up" the bit-rate filtered output from the quadrature demodulator. The decision threshold voltage level for the 1-bit comparator is stored on an external capacitor connected to the FSKREF pin.

## REGULATOR

The on-chip 1.0V regulator requires a suitable off-chip PNP transistor to achieve regulation. The external PNP transistor should have an hFE>200 for VCE>=0.1V.

## LOW BATTERY ALARM

The low battery alarm output, ALM, is normally low, but rises to 1.1V (=VCC) when the VCC voltage falls below approximately 1.1V.

# UTCTA31142 LINEAR INTEGRATED CIRCUIT

## TYPICAL CHARACTERISTICS

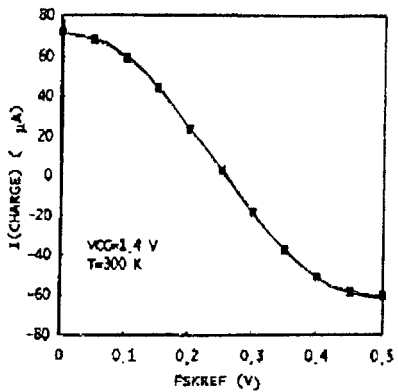
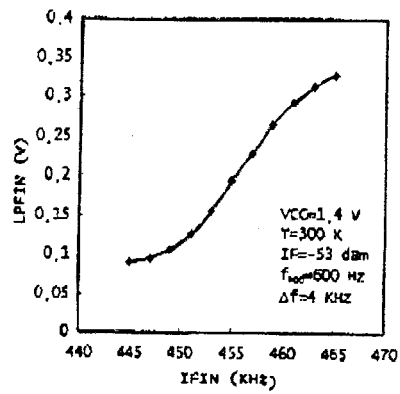
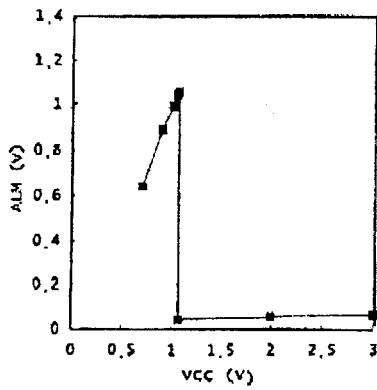
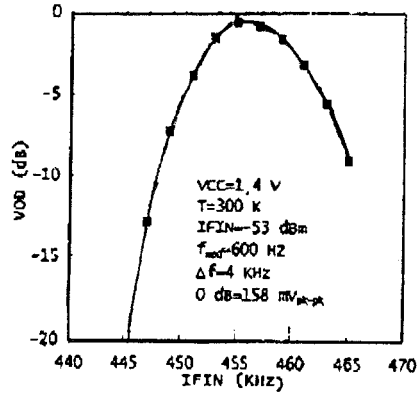
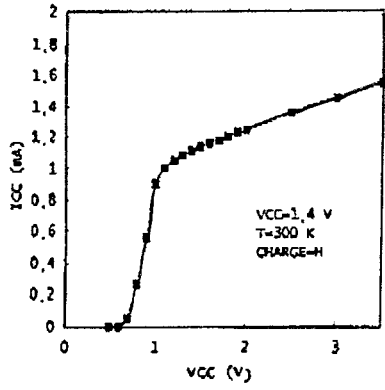

# UTCTA31142 LINEAR INTEGRATED CIRCUIT

## TEST CIRCUIT

