

FEATURES

- Wide Operating Voltage Range
- High Limiting Sensitivity
- Low Current Consumption
- 60 MHz IF Input
- 4 to 10 Volt Operation

DESCRIPTION

The TK10420 integrated circuit has been developed for the FM IF system in communications equipment. The circuit operates on 4 to 10 volts and has low current consumption. The IC is most suited for receivers using double conversion. The IF input can be as high as 60 MHz and the second IF is 455 kHz.

The TK10420 is available in DIP16 dual in-line and surface mount MFP20 packages.

ORDERING INFORMATION

TK10420 □ □ □

Tape/Reel Code

Temp. Range

Package Code

PACKAGE CODE	TEMP. RANGE	TAPE/REEL CODE
M : Surface Mount	C : -20 to +70 °C	BX : Bulk/Bag
D : Plastic Dip		TX : Paper Tape
		TR : Tape Right
		TL : Tape Left
		MG : Magazine

APPLICATIONS

- Communications Equipment
- HAM Radio Transceivers
- VHF/UHF Handy Talkies
- Scanners
- Data Transponders
- Cordless Phones
- Cellular Phones

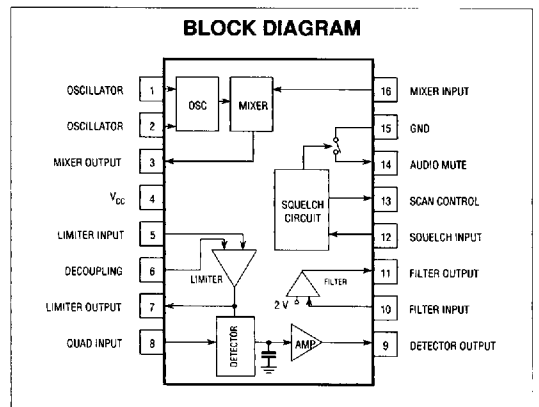
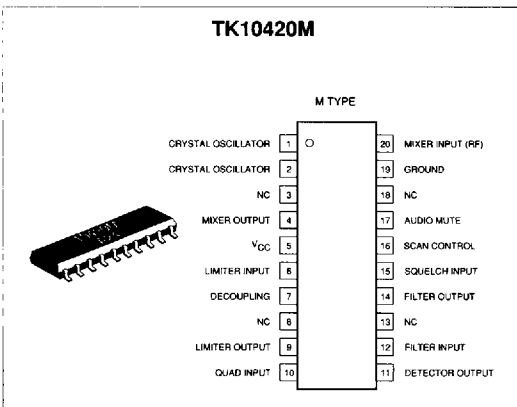
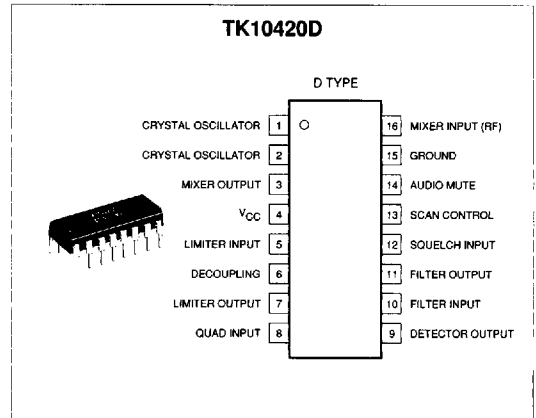

TK10420

ABSOLUTE MAXIMUM RATINGS

Input Voltage V_{CCMAX} 12 V
 Power Dissipation TK10420D (Note 1) 700 mW
 Power Dissipation TK10420M (Note 2) 410 mW
 Junction Temperature 150 °C

Storage Temperature Range -55 to +125 °C
 Operating Temperature Range -30 to +70 °C
 Lead Soldering Temp. (10 sec.) 300 °C

ELECTRICAL CHARACTERISTICS

Test conditions: $V_{CC} = 6.0$ V, $f_O = 10.7$ MHz, $\Delta f = \pm 3.0$ kHz, $f_{MOD} = 1$ kHz, $T_A = 25^\circ\text{C}$

SYMBOL	PARAMETER	TEST CONDITIONS	MIN	TYP	MAX	UNITS
I_{CC1}	Current Consumption	$V_{12} = 2 V_{DC}$		2.5	3.5	mA
I_{CC2}	Current Consumption	$V_{12} = 0 V_{DC}$		4.0	5.5	mA
Limit	Limiting Sensitivity	-3 dB V_{OUT}		3.0	10.0	μV
V_{DC}	Detector Output Term. Voltage	$V_{IN} = 10$ mV (RF); no mod.		3.0		mV
Z_{OUT}	Detector Output Impedance	$V_{IN} = 10$ mV (RF)		400	990	Ω
V_{OUT}	Detector Output Voltage	$V_{IN} = 10$ mV (RF)	300	550.0		mV(rms)
F_{GAIN}	Filter Gain	$f = 10$ kHz, $V_{IN} = 3$ mV	40.0	46.0		dB
F_{DC}	Filter Terminal Voltage	At no input	1.8	2.0	2.5	V_{DC}
HYS	Trigger Hysteresis		50	100		mV
M_L	Mute Switch Resistance	$V_{12} = 0 V_{DC}$		15	50	Ω
M_H	Mute Switch Resistance	$V_{12} = 2 V_{DC}$	1	10		M Ω
S_L	Scan Control Voltage	$V_{12} = 2 V_{DC}$		0	0.5	V_{DC}
S_H	Scan Control Voltage	$V_{12} = 0 V_{DC}$	5			V_{DC}
M_G	Mixer Conversion Gain			20		dB
M_{INR}	Mixer Input Resistance			3.3		k Ω
M_{INC}	Mixer Input Capacitance			2.2		pF
F_{OP}	Operating Frequency Range			60		MHz

Note 1: Power dissipation must be derated at the rate of 5.6 mW/ °C for operation at $T_A = 25^\circ\text{C}$ and above.

Note 2: Power dissipation must be derated at the rate of 3.3 mW/ °C for operation at $T_A = 25^\circ\text{C}$ and above.

TYPICAL APPLICATION

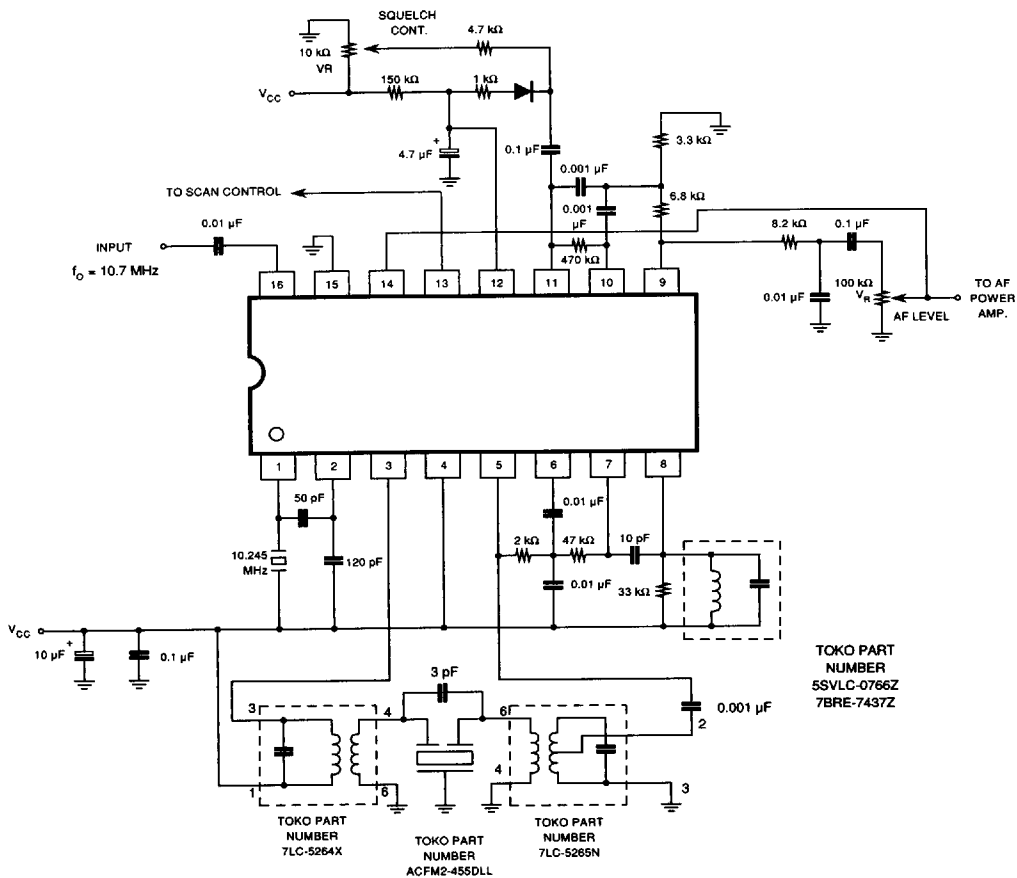

TOKO PART NUMBER
5SVLC-0766Z
7BRE-7437Z

TYPICAL PERFORMANCE CHARACTERISTICS

MIXER CONVERSION GAIN vs. POWER SUPPLY VOLTAGE

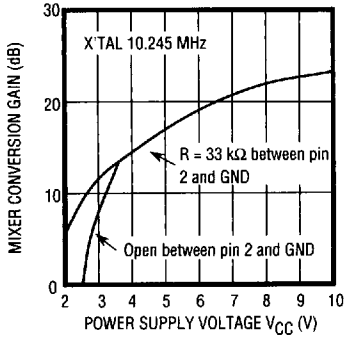

MIXER AND IF CHARACTERISTICS (10.7 MHz)

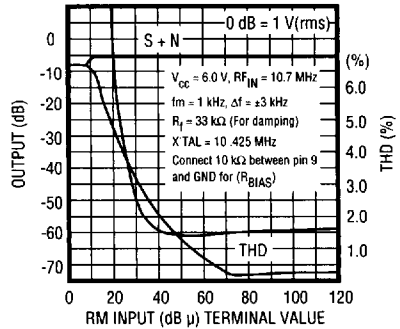

-3 dB LIMITING SENSITIVITY vs. POWER SUPPLY VOLTAGE

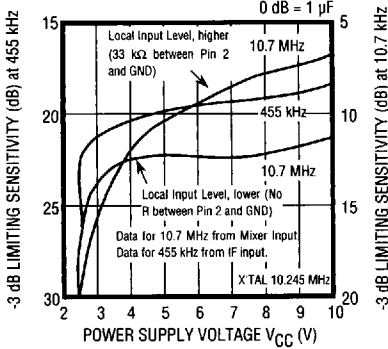

MIXER AND IF CHARACTERISTICS (50 MHz)

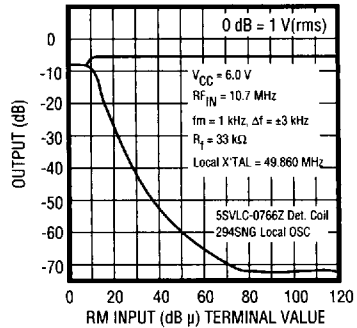

4