

High Voltage Fast-switching NPN Power Transistor

(Pb) Lead(Pb)-Free

DESCRIPTION:

The device is manufactured using high voltage Multi Epitaxial Planar technology for high switching speeds and medium voltage capability.

It uses a Cellular Emitter structure with planar edge termination to enhance switching speeds while maintaining the wide RBSOA.

The MJE13003B is designed for use in compact fluorescent lamp application.

FEATURE:

- * Medium Voltage Capability
- * Low Spread Of Dynamic Parameters
- * Minimum Lot-to-lot Spread For Reliable Operation
- * Very High Switching Speed

APPLICATIONS:

- * Electronic Ballasts For Fluorescent Lighting

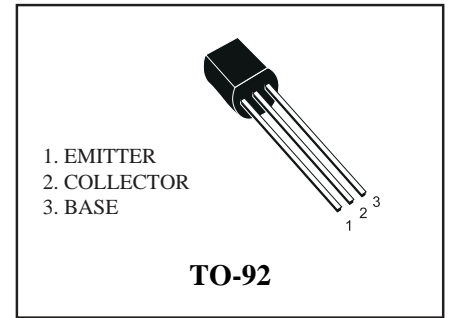
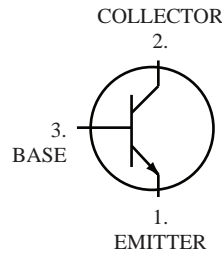

ABSOLUTE MAXIMUM RATINGS

Parameter	Symbol	Value	Unit
Collector-Emitter Voltage ($V_{BE} = 0$)	V_{CES}	700	V
Collector-Emitter Voltage ($I_B = 0$)	V_{CEO}	400	V
Emitter-Base Voltage ($I_C = 0$)	V_{EBO}	9	V
Collector Current	I_C	1	A
Collector Peak Current ($t_p < 5$ ms)	I_{CM}	2	A
Base Current	I_B	0.5	A
Base Peak Current ($t_p < 5$ ms)	I_{BM}	1	A
Total Dissipation at $T_{amb} = 25$ °C	P_{tot}	1	W
Thermal Resistance Junction-ambient	$R_{\theta JA}$	120	°C/W
Operating Junction Temperature	T_j	150	°C
Storage Temperature	T_{stg}	-65 to 150	°C

ELECTRICAL CHARACTERISTICS (T_{case} = 25 °C unless otherwise specified)

Parameter	Symbol	Min.	Typ.	Max.	Unit
Collector Cut-off Current (V _{BE} = -1.5V)	I _{CEV}			1 5	mA mA
Emitter Cut-off Current (I _C = 0)	I _{EBO}			1	mA
Collector-Emitter Sustaining Voltage (I _B = 0)	V _{CEO(sus)}	400			V
Collector-Emitter Saturation Voltage	V _{CE(sat)}		0.2 0.3 0.4	0.5 1 1.5	V V V
Base-Emitter Saturation Voltage	V _{BE(sat)}			1 1.2	V V
DC Current Gain	h _{FE}	10 5		30 20	
INDUCTIVE LOAD Fall Time	t _f		0.3		μs

Pulsed: Pulse duration = 300μs, duty cycle = 1.5 %

Ratings and Characteristic Curves

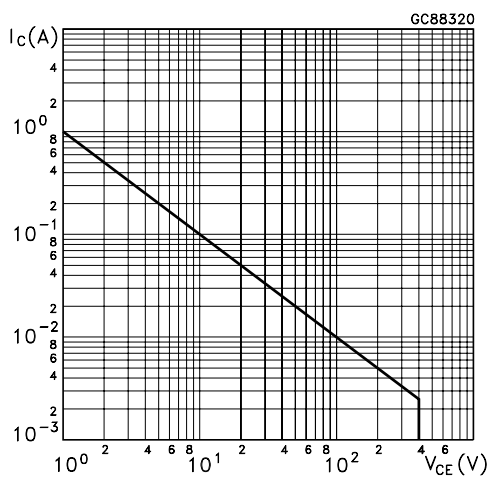

Fig.1 Safe Operating Area

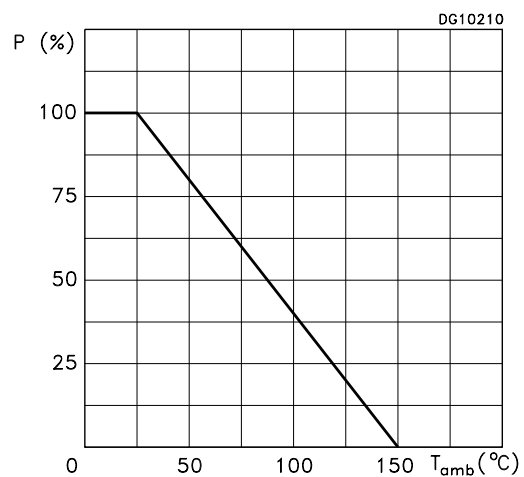

Fig.2 Derating Curve

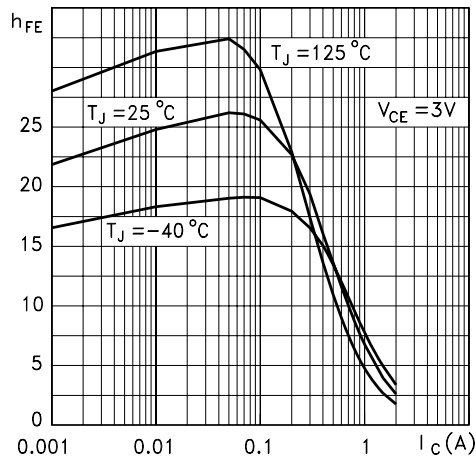

Fig.3 DC Current Gain $V_{CE}=3V$

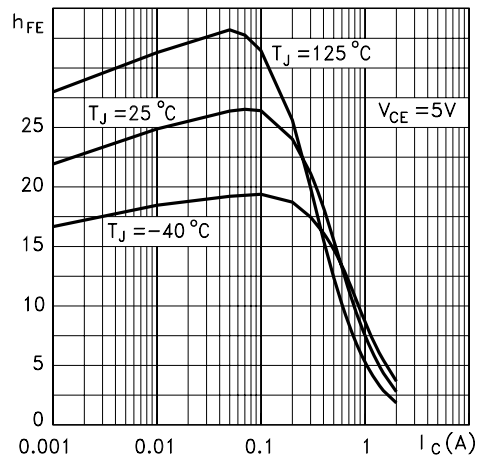

Fig.4 DC Current Gain $V_{CE}=5V$

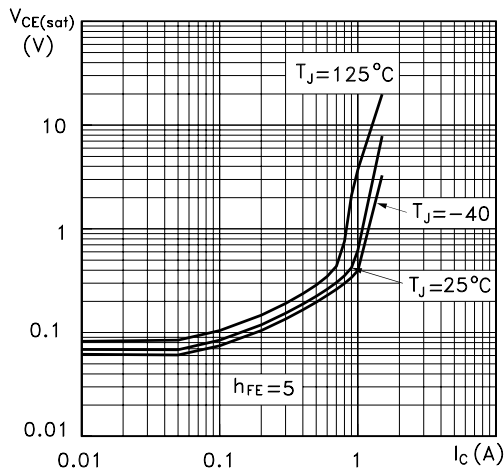

Fig.5 Collector Emitter Saturation Voltage

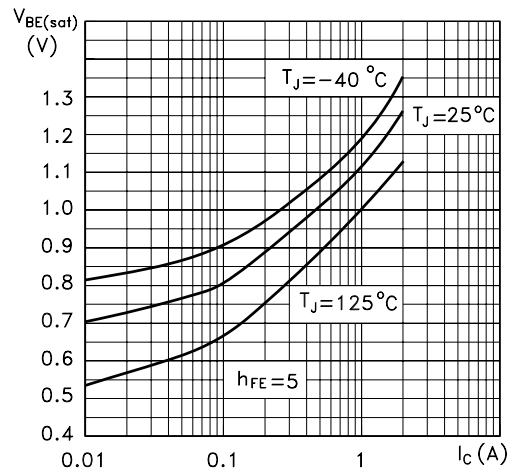

Fig.6 Base Emitter Saturation Voltage

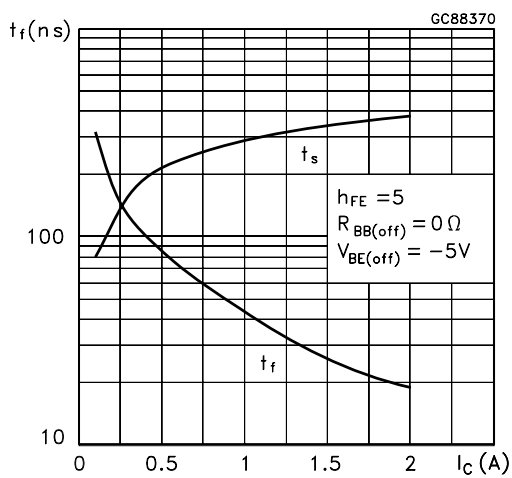
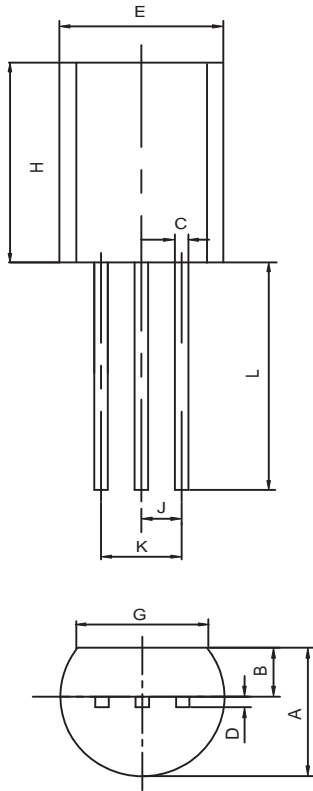

Fig.7 Switching Time Inductive Load

TO-92 Outline Dimensions

unit:mm



TO-92		
Dim	Min	Max
A	3.30	3.70
B	1.10	1.40
C	0.38	0.55
D	0.36	0.51
E	4.40	4.70
G	3.43	-
H	4.30	4.70
J	1.270TYP	
K	2.44	2.64
L	14.10	14.50